



aerospace
climate control
electromechanical
filtration
fluid & gas handling
hydraulics
pneumatics
process control
sealing & shielding



[Click to Go to
CATALOG
Table of Contents](#)

Fluid Power Seal Design Guide

Catalog EPS 5370

06/2014



ENGINEERING YOUR SUCCESS.

If you have questions about the products contained in this catalog, or their applications, please contact:



**Engineered Polymer Systems
Division**
phone **801 972 3000**
fax **801 973 4019**
eps-ccare@parker.com
www.parker.com/eps

Care is taken in the preparation of this publication; however Parker shall not be responsible for a user's reliance on any inadvertent typographical errors or omissions. Information in this catalog is only accurate as of the date of publication. For more current information, please consult the Parker EPS Division website at www.parker.com/eps.

Offer of Sale

The items described in this document are hereby offered for sale by Parker Hannifin Corporation, its subsidiaries or its authorized distributors. This offer and its acceptance are governed by the provisions in the "Offer of Sale."

NOTE: Failure or improper selection or improper use of seals or related items can cause death, personal injury and property damage. Parker Hannifin shall not be liable for any incidental, consequential or special damages that result from use of the information contained in this publication.



FAILURE OR IMPROPER SELECTION OR IMPROPER USE OF THE PRODUCTS AND/OR SYSTEMS DESCRIBED HEREIN OR RELATED ITEMS CAN CAUSE DEATH, PERSONAL INJURY AND PROPERTY DAMAGE.

This document and other information from Parker Hannifin Corporation, its subsidiaries and authorized distributors provide product and/or system options for further investigation by users having expertise. It is important that you analyze all aspects of your application, including consequences of any failure and review the information concerning the product or system in the current product catalog. Due to the variety of operating conditions and applications for these products or systems, the user, through its own analysis and testing, is solely responsible for making the final selection of the products and systems and assuring that all performance, safety and warning requirements of the application are met.

The products described herein, including without limitation, product features, specifications, designs, availability and pricing, are subject to change by Parker Hannifin Corporation and its related companies at any time without notice.



Table of Contents

Click on a section title
to jump to that section.

[1 Introduction](#)

[2 Engineering](#)

[3 Materials](#)

[4 Fluid Power Applications](#)

[5 Rod Seals](#)

[6 Symmetrical Seals](#)

[7 Piston Seals](#)

[8 Wipers](#)

[9 Wear Rings / Bearings](#)

[10 Back-ups](#)

[11 Urethane O-Rings / D-Rings / Head Seals](#)

[12 Metric Seals](#)



Parker Hannifin Corporation
Engineered Polymer Systems Division
Phone: 801 972 3000
Fax: 801 973 4019

www.parker.com/eps

Appendix Table of Contents

Click on an appendix title
to jump to that appendix.

A [Design Action Request Form](#)

B [English / Metric Conversions](#)

C [Custom Groove Calculations](#)

D [AN6226 Gland Dimensions
& Tolerances \(Army / Navy\)](#)

E [MS-28776 \(MS-33675\) Dash Size
Grooves \(for SH959 Profile Wipers\)](#)

F [Commercial PTFE Back-Ups for Retrofit
MS-28774 and MS-27595 Grooves](#)

G [ISO Gland Tolerances](#)

Introduction

Parker Hannifin is the industry leader for sealing system solutions for the fluid power industry.

Parker Engineered Polymer Systems Division offers equipment manufacturers the most comprehensive selection of fluid power seals for hydraulic and pneumatic applications. Our expertise and complete product offering means Parker is your one source manufacturer and sealing solution partner. Our innovative technology and value-added services allow us to engineer your success with leading edge material development, experienced design, high quality manufacturing, and outstanding customer service.

This guide provides design engineers with a range of profile and compound combinations to configure part numbers for complete sealing systems for most applications. The catalog offering includes gland calculation tables for standard profiles and preferred profiles which conform to conventional gland and cylinder designs.

Technical Assistance

If you need assistance, Parker's team of experienced application engineers is available to help with selection recommendations.

Custom Designs and Material Formulations

In addition to our catalog offering, our research and development team can collaborate with you to design custom systems. Our material science capabilities include the ability to modify existing compounds to meet application requirements, or develop new formulations.

Definition of Terminology Used in This Catalog

Availability

Part number configurators and gland calculation tables for recommended cross-sections in common size ranges are provided for all profiles in this catalog. Information on where to check for current availability of sizes, cross-sections and part numbers not listed is provided in the respective profile tables.

Preferred Profiles

Profiles designated as "Preferred Profiles" represent advanced Parker sealing technology and compound combinations

Parker Standard Sizes

Preferred Profiles contained in this catalog are available in "Parker Standard Sizes" and respective seal materials as shown in the respective profile Gland Dimension table with the "Parker Standard Sizes" designation. The part numbers displayed in these tables may be ordered from Parker without necessity of tooling charges. Minimum orders quantities apply and lead times may vary.

◆ Preferred Profiles

Preferred Profiles represent advanced Parker sealing technology and compound combinations.

◆ Parker Standard Sizes

Exact part numbers which are displayed in Preferred Profile tables may be ordered from Parker without necessity of tooling charges.¹

¹ Minimum order quantities apply and lead times may vary.

Parker Fluid Power Seals

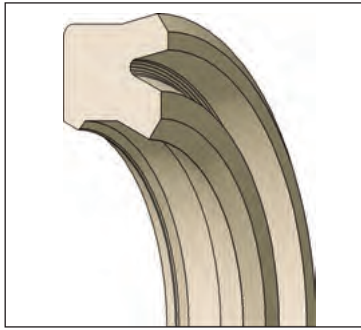

Rod Seals

Rod Seals, which guard against external leakage, are one of the most vital components of the sealing system. In recognition of their critical nature, Parker is pleased to offer the most complete range of materials and profiles in the industry. Our portfolio of advanced plastic, rubber and PTFE materials delivers the highest performance in a wide variety of rod seal applications. Cutting edge technologies include multiple sealing lip systems, shock-load resistance, low friction and ultra-dry capability.

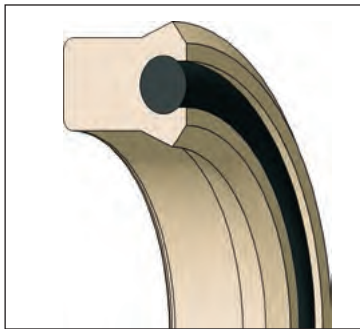

Symmetrical Seals

With thousands of available size and material combinations, Parker symmetrical profiles are designed to act as either rod or piston seals, allowing one part number to function in two applications. Often copied but never equaled, the PolyPak® for hydraulic applications and the 8400 u-cup for pneumatic applications have revolutionized the fluid power industry and become trusted standards. Symmetrical u-cups and squeeze seals are available in a variety of lip shapes and materials.

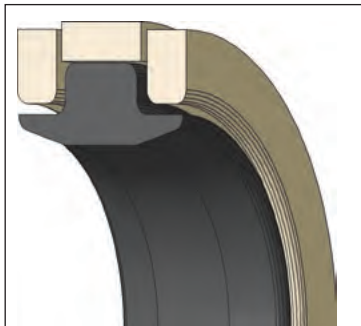

Piston Seals

Our diverse product line of piston seal profiles suits a broad range of hydraulic and pneumatic applications. Whatever the need, from low pressure pneumatics to extreme hydraulic shock loading, Parker has the solution. Profiles are available to meet the demands of uni-directional and bi-directional pressure, low friction, easy installation, port passing, and zero-drift scenarios.

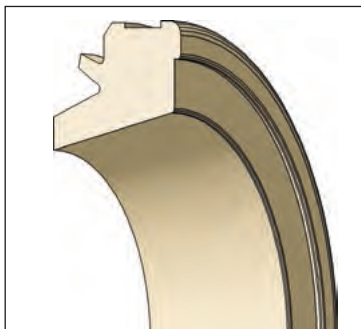

Wipers

Just as rod seals are designed to keep fluid in, Parker wipers perform to keep contamination out. Wipers work in conjunction with rod seals to form the first line of defense in protecting a system and keeping it free from dirt, mud, water, and other contaminants. Incorporating the latest technology in aggressive wiping lips and OD exclusion, Parker has solutions in press-in, snap-in, and double lip profiles.

Wear Rings and Bearings

Parker offers a complete line of wear rings and bearing products to fit any application. The product offering meets the full spectrum of needs, from heavy duty hydraulic cylinders operating under the highest temperatures and pressures to pneumatic applications requiring low friction, long life and self-lubrication. No matter what the application demands, Parker's diverse bearing product line ensures that performance requirements are met with maximized value.

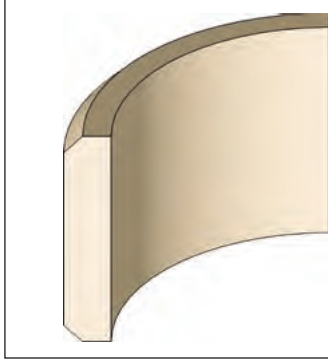

Back-up Rings

Parker back-up rings offer simple solutions to safely increase system pressure or solve an existing seal extrusion problem. Standard profiles are available in a variety of materials to complement virtually any Parker rod or piston profile.

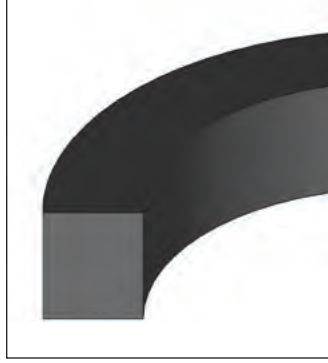

Polyurethane O-rings, D-rings and Head Seals

Parker is pleased to offer the material advantages of the Resilon® family of high performance polyurethanes in standard and custom o-ring sizes. With high temperature Resilon o-rings and D-rings, the need for back-ups can be eliminated, simplifying installation and reducing damage due to spiral failure. Static polyurethane head seals are ideal for replacing o-rings and back-ups in hydraulic cylinder heads, fool-proofing installation and eliminating failures due to back-up pinching and blow-out.



Metric Seals

Preferred Profile rod, wiper, and piston seal designs are offered in metric Parker Standard Sizes.

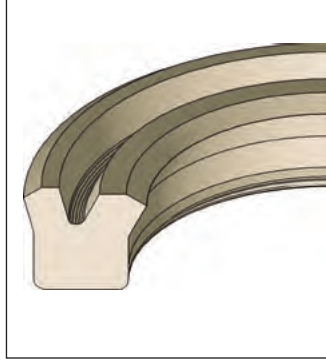

Rod Seals (See Section 5)



























Profile	Description	Application (Duty)				Page
		Hydraulic			Pneumatic	
		Light	Medium	Heavy		
◆ BD	Premium non-symmetrical o-ring energized rod seal with a knife trimmed primary lip and molded secondary lip. Preferred material is 4300. Additional materials include 4301, 5065.					5-5
	BD Profile with positively actuated back-up. Preferred material is 5065 with 4655 back-up.					5-9
◆ BT	Premium non-symmetrical u-cup rod seal with a knife trimmed primary lip and molded secondary lip. Preferred material is 4300.					5-13
◆ BR	Premium knife trimmed buffer or secondary seal designed to work with a primary rod seal for heavy duty or zero-leak systems. Preferred material is 4300.					5-17
B3	Non-symmetrical u-cup with knife trimmed lip. Standard materials include 4300, 4700, 5065.					5-21
BS	Non-symmetrical u-cup rod seal with knife trimmed primary lip and molded secondary lip. Standard materials are 4300 family, 4700, 5065.					5-23
UR	Standard non-symmetrical u-cup with trimmed lip. Standard material is 4615.					5-25
E5	Non-symmetrical low friction rounded lip pneumatic rod seal. Standard materials include 4274, 4180, 4208, 5065.					5-27
TR	Bi-directional rod "T-seal" available in no back-up, single back-up, and two back-up o-ring groove sizes. Standard energizer materials include 4115, 4274, 4205, 4259. Back-ups available in Nylon, PTFE, PEEK.					5-29
ON	Bi-directional, rubber energized PTFE cap rod seal. Full range of energizer and PTFE materials available.					5-32
CR	Bi-directional, low profile, rubber energized PTFE cap rod seal designed to fit standard o-ring glands. Full range of energizer and PTFE materials available.					5-34
OC	Standard bi-directional rubber energized rectangular PTFE cap rod seal. Full range of energizer and PTFE materials available.					5-36
OD	Uni-directional rubber energized PTFE rod seal, typically used as a buffer or secondary rod seal. Full range of energizer and PTFE materials available.					5-38
V6	Pneumatic cushion or check valve rod seal used to cushion the piston using internal pressure. Standard materials include 4622, 4180, 4181, 4208.					5-40
OR	Bi-directional rubber energized PTFE rod seal used in rotary or oscillating applications. Full range of energizer and PTFE materials available.					5-42

◆ Preferred Profile (see page 1-1 for definition).



















06/01/2014



Symmetrical Seals for Rod or Piston Applications (See Section 6)











































Profile	Description	Application (Duty)				Page
		Hydraulic			Pneumatic	
		Light	Medium	Heavy		
SPP	 Standard PolyPak®. A square shaped symmetrical squeeze seal with a knife trimmed scraper lip. Standard materials include 4615, 4622, 4651, 4263, 4207, 4266.					6-6
DPP	 Deep PolyPak. A rectangular shaped symmetrical squeeze seal with a knife trimmed scraper lip. Standard materials include 4615, 4622, 4651, 4263, 4207, 4266.					6-10
BPP	 Type B PolyPak. A rectangular shaped symmetrical squeeze seal with a knife trimmed beveled lip. Standard materials include 4615, 4622, 4651, 4263, 4207, 4266.					6-14
 8400 8500	 Symmetrical rubber u-cups used primarily in pneumatic applications. 8400 series feature knife trimmed with a beveled lip. 8500 series feature a straight cut scraper lip. Preferred material is 4180. Additional materials include 4274, 4208.					6-18
SL	 A dual lip seal created by the combination of a standard square PolyPak shell and a rubber lip seal/ energizer. Standard materials are a 4615 shell and 4180 lip seal/ energizer. Also known as SCL-Pak.					6-24
US	 Standard symmetrical u-cup with trimmed beveled lips. Standard material is 4615.					6-27
AN 6226	 Industry standard symmetrical u-cups per the old Army / Navy (AN) specification. Standard material is 4295.					6-30

Piston Seals (See Section 7)





























 BP	 Premium bi-directional rubber energized urethane cap piston seal. Preferred material is 4304.					7-5
 PSP	 Standard bi-directional rubber energized urethane cap piston seal. Preferred material is 4622. Additional material includes 4300.					7-8
CT	 Four piece capped "T-seal" piston seal made from molded rubber energizer, PTFE cap, and 4655 back-ups.					7-11
OK	 Bi-directional rubber energized step-cut nylon cap piston seal.					7-13
PIP	 Bi-directional piston seal created by the combination of a PIP Ring® pressure inverting pedestal back-up ring and Type B PolyPak®. Standard material is a 4615 PolyPak with a 4617 PIP Ring.					7-15
B7	 Premium non-symmetrical u-cup with knife trimmed lip piston seal. Standard materials include 4300, 4700, 5065.					7-17

 Preferred Profile (see page 1-1 for definition).















06/01/2014

Profile		Description	Application (Duty)				Page
			Hydraulic			Pneumatic	
			Light	Medium	Heavy		
UP		Standard non-symmetrical u-cup with trimmed beveled lip piston seal. Standard material is 4615.					7-19
E4		Non-symmetrical low friction rounded lip pneumatic piston seal. Standard materials include 4274, 4180, 4208, 50 65.					7-21
BMP		Low friction bumper and round lip seal profile for use in pneumatic applications. Standard materials include 4283, 4274 and 4208.					7-23
TP		Bi-directional piston "T-seal" available in no back-up, single back-up, and two back-up o-ring groove sizes. Standard energizer materials include 4115, 4274, 4205, 4259. Back-ups available in Nylon, PTFE, PEEK.					7-25
S5		Economical medium duty bi-directional o-ring energized PTFE piston seal. Standard material is 0203 15% fiberglass-filled PTFE with nitrile energizer. Split option available.					7-28
R5		Medium to heavy duty bi-directional lathe cut energized PTFE piston seal. Full range of energizer and PTFE materials available. Split option available.					7-30
CQ		Bi-directional three piece lathe cut energized PTFE cap piston seal with an integrated quad seal for zero drift. Also available with dual o-ring energizer.					7-32
OE		Bi-directional, rubber energized PTFE cap piston seal. Full range of energizer and PTFE materials available.					7-34
OG		Uni-directional rubber energized PTFE piston seal, typically used as a buffer or secondary piston seal. Full range of energizer and PTFE materials available.					7-36
CP		Bi-directional low profile, rubber energized PTFE cap piston seal designed to fit standard o-ring glands. Full range of energizer and PTFE materials available.					7-38
OA		Standard bi-directional rubber energized rectangular PTFE cap piston seal. Full range of energizer and PTFE materials available.					7-40
OQ		Bi-directional rubber energized PTFE piston seal used in rotary or oscillating applications. Full range of energizer and PTFE materials available.					7-42

Wipers (See Section 8)

Profile	Description	Application (Duty)				Page
		Hydraulic			Pneumatic	
		Light	Medium	Heavy		
◆ YD 	Premium snap-in wiper with OD exclusion lip and a knife trimmed wiping lip. Preferred materials are 4300, 4301.					8-5
◆ SHD 	Slotted heel snap-in wiper for pneumatics and light to medium duty hydraulics. Preferred materials are 4615 and 5065. Additional materials include 4263, 4208, 4207.					8-9
SH959 	An industry standard slotted heel Army / Navy (AN) wiper designed to fit MS-28776 (MS-33675) grooves. Standard materials are 4615, 5065.					8-13
AH 	Double-lip, press in place, metal canned wiper with knife trimmed sealing lip for heavy duty hydraulics. Standard materials are 4300, 4700, 4615.					8-15
◆ J 	Standard single-lip, press in place, metal canned wiper with a knife trimmed lip for medium and heavy duty hydraulics. Preferred material is 4700. Additional materials include 4300, 4615.					8-17
◆ AY 	Premium snap-in place double-lip wiper for hydraulic applications. Preferred materials are 4300, 4301. Additional material includes 4700.					8-19
H/8600 	Standard snap-in place double-lip wiper. Standard materials for H wiper are 4615, 5065. Standard material for 8600 wiper is 4181.					8-22
AD 	Double acting, double-lip, rubber energized PTFE wiper. Full range of energizer and PTFE materials available.					8-24



















Wear Rings / Bearings (See Section 9)

◆ WPT 	Tight tolerance piston wear ring with chamfered corners. Standard material is 4733 WearGard™.					9-8
◆ WRT 	Tight tolerance rod wear ring with chamfered corners. Standard material is 4733 WearGard.					9-12
PDT 	PTFE wear strip/bearing available cut to length or in bulk rolls. A variety of PTFE compounds are available.					9-16
PDW 	Precision cut wear ring/bearing machined from PTFE billet material. Rod and piston chamfer may apply.					9-20















◆ Preferred Profile (see page 1-1 for definition).

Introduction











Back-ups (See Section 10)

Profile	Description	Application (Duty)				Page
		Hydraulic			Pneumatic	
		Light	Medium	Heavy		
MB	 Heavy cross-section modular back-up for PolyPak® seals. Standard materials are 4617, 4652.					10-4
8700	 Light cross-section back-up for PolyPak and u-cup seals. Standard material is 4651.					10-6
5100	 Back-up rings designed for o-ring grooves. Standard material is 4651.					10-8
PAB	 Positively actuated back-up ring incorporated into common seal profiles to extend a seal's pressure range. Sold as an assembly with the seal.					10-11
PDB	 Anti-extrusion PTFE ring offered in solid and split configurations. Full PTFE material range applies.					10-12
WB	 Anti-extrusion wedged back-up ring set for extreme high pressure, high temperature environments.					10-14

Urethane O-Rings, D-Rings and Head Seals (See Section 11)

568	 High performance urethane o-ring made from the Resilon® family of high temperature, low compression set urethanes. Preferred materials are Resilon® 4300, 4301.					11-3
DG	 One-piece hydraulic valve sealing solution designed to replace o-ring and back-ups in dynamic applications. Preferred materials are Resilon® 4300, 4301.					11-9
HS	 Static head seals designed to replace o-rings and back-up in static applications. Standard material is 4700.					11-11





Metric Seals, Preferred Profiles (See Section 12)

BT	 Premium non-symmetrical u-cup rod seal with a knife trimmed primary lip and molded secondary lip. Preferred material is 4300.					12-3
AY	 Premium snap in place double-lip wiper for hydraulic applications. Preferred material is Resilon® 4300.					12-5
BP	 Premium bi-directional rubber energized urethane cap piston seal. Preferred material is 4304.					12-7

General Application Guidelines

Parker's selection of products is the broadest offering in the industry for hydraulic and pneumatic sealing systems. Table 1-1 provides "General Application Guidelines" to help define possible differences between light, medium and heavy duty applications. The product profile charts beginning on [page 1-4](#) show corresponding application duty recommendations for each profile.

Table 1-1. General Application Guidelines.

Application Parameter	Hydraulic			Pneumatic	
	 Light Duty	 Medium Duty	 Heavy Duty	 Light Duty	 Heavy Duty
Pressure Range	<1200 psi (<83 bars)	<3500 psi (<241 bars)	>3500 psi (>241 bars)	1 to 200 psi (0 to 14 bar)	Above 200 psi (Above 14 bars)
Pressure Spikes	None or low	Not to exceed twice the system pressure. Short duration such as valve shifting.	Pressure spikes that may be several times the system pressure and of a longer duration. These are often mechanically induced by forcing the rod in or out.	Because of the compressive nature of gases pressure spikes are typically not a problem.	Because of the compressive nature of gases pressure spikes are typically not a problem.
Temperature Range	0°F to +160°F (-18°C to +71°C)	-20°F to +200°F (-29°C to +93°C)	-45°F to +225°F (-43°C to +107°C)	0°F to +72°F (-18°C to +22°C)	Cryogenic to +450°F (+232°C)
Contamination	Low or non existing	Moderate with cylinder in horizontal or inverted position.	Moderate to high with the cylinder upright – vertical	Low or non existing	Moderate to high with the cylinder upright – vertical
Side Loading	None to light with shorter stroke and vertical cylinder mount.	Moderate side load with cylinder mounted towards the vertical position. Medium stroke.	Longer stroke lengths. Cylinder mounted horizontal, heavy side loading.	None to light with shorter stroke and cylinder mount vertical.	Longer stroke lengths. Cylinder mounted horizontal, heavy side loading.

It is not uncommon for the requirements of a sealing system to fall into multiple duty columns. When this situation occurs you should select the majority of your components from the higher range.

When selecting a wiper, focus on contamination section.

In selecting a sealing component you will evaluate the temperature, pressure and pressure spike variables of the application. With a wear ring, you will want to look at the temperature and side loading section. This does not preclude the need to consider such things as fluid being sealed and stroke speed.

The Parker Advantage

Parker is the world's leading diversified manufacturer of motion and control technologies and systems, providing precision-engineered solutions for a wide variety of commercial, mobile, industrial and aerospace markets. The Engineered Polymer Systems (EPS) Division of Parker Engineered Materials Group, has over 40 years experience designing and manufacturing elastomeric, polymeric and plastic seals, materials, and sealing systems for dynamic applications.

Global Access

Working with Parker EPS Division gives you access to all of Parker's seal products in North America, Europe, and Asia. Our established worldwide network of over 300 distributor and service center locations combined with factory direct representatives, including global sales and application engineering, ensures access to quality products and engineering services anytime, anywhere.

Quality Commitment

Parker strives to deliver excellence in quality and service through continuous improvement of our people, products and systems. Our quality registrations include manufacturing sites registered to AS9100, ISO/9000, TS16949, and ISO13485 standards.

Our implementation of Lean principles drives productivity improvements in all operations to support our goal of adding value – in every step of our process – to the things that matter most to our customers.

Manufacturing Excellence

Parker's manufacturing capabilities accommodate a wide range of dynamic sealing needs, providing the following value benefits to our customers:

- State of the art manufacturing processes and procedures that enable Parker to provide world class products, in both standard and custom designs
- Specialized cellular manufacturing and Lean concepts that sustain both low and high volume runs with equal efficiency
- Tooling capability breadth to produce seal diameters as small as 1/16 inch and as large as 9 feet without splicing
- Custom high speed trim machines that ensure a sharp sealing edge for the ultimate seal performance wherever possible.

Applications Engineering

Our team of experienced application engineers can help you find the most reliable, cost-effective sealing solution for your product. These engineers are experts, combining decades of sealing experience



Injection Molding Operations

in real-world applications with a full complement of technology-driven tools to produce the answers you need.

FEA

Utilizing advanced non-linear Finite Element Analysis (FEA) software our engineers can perform extremely accurate virtual simulations of material performance based on actual physical test data. These simulations eliminate the need for multiple iterations of costly prototype tooling, and dramatically reduce development lead times. They also ensure first-time selection of the best material and geometry for your application.

Mechanical Test Lab

Parker's mechanical test lab is an important asset for validating new designs and qualifying seals to customers' performance specifications. Our sophisticated mechanical test lab utilizes several breakthrough technologies, enabling engineers to validate seals and sealing systems for hydraulic, pneumatic and rotary systems. All product testing is carried out in accordance with ASTM and SAE specifications. In addition, we conduct environmental testing to customer-specific requirements modeled after field use conditions.

Premier Customer Support

Worldwide support is just a phone call away. Parker sales representatives provide a single point of contact for sealing support.

Contents

Sealing Theory.....	2-1
Static vs. Dynamic Sealing.....	2-1
Leakage Control.....	2-2
Lip vs. Squeeze Seals.....	2-2
Effects of Lip Geometries.....	2-3
Friction.....	2-3
Pressure Effects and Extrusion.....	2-4
Seal Wear.....	2-5
Seal Stability.....	2-6
Surface Speed.....	2-6
Compression Set.....	2-7
Influence of Temperature.....	2-7
General Guidelines for Hardware Design.....	2-8
Hardware Surface Finish.....	2-9
Surface Finish Guidelines for Reciprocating Seals.....	2-11
Surface Finish FAQs.....	2-13
Installation	
Considerations.....	2-14
Installation Tools – Piston.....	2-16
Installation Tools – Rod.....	2-17
Finite Element Analysis.....	2-18

Parker Fluid Power Seals for All Application Technologies

Seals have been used since ancient times and have evolved into a wide variety of shapes and materials. For those who are not familiar with sealing technology, the number of options available can be confusing. Selecting the most suitable product for a given application can be difficult. This engineering section will assist in product selection by explaining the fundamentals of seal design and material technology.

Sealing Theory

Static vs. Dynamic Sealing

Every seal, whether static or dynamic, must seal against at least two contacting surfaces. In static applications, both surfaces are non-moving relative to one another. In dynamic applications at least one surface is in motion relative to the other sealing surface(s). For example, in a standard hydraulic cylinder, the rod and piston seals would be classified as dynamic seals, while the seal between the bore and the head gland would be considered a static seal.

In both static and dynamic applications, a certain amount of squeeze or compression is required upon installation to maintain contact with the sealing surfaces and prevent fluid leakage. Dynamic applications in particular involve other variables and require that additional factors be evaluated to ensure proper system performance. These variables are discussed in this section.

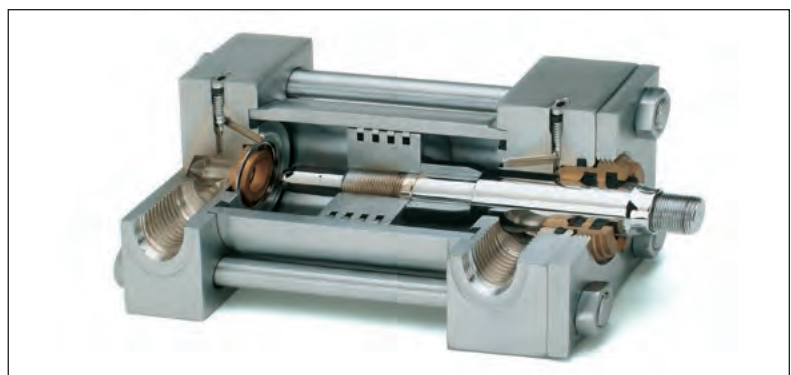

Fig. 2-1. Hydraulic cylinder

Leakage Control

When choosing a sealing system, the desired result is ultimately leakage control. Seal design and material improvements have made it possible not only to have seal combinations that provide zero leakage, but also provide extended life in a variety of applications. Aside from the seals themselves, a thorough understanding of system parameters is necessary to obtain the best results.

Optimal sealing is best achieved by taking a systems approach to the seal package rather than considering components individually. Our profiles have been designed specifically to complement one another to create high performance systems. For example, pairing a Parker rod seal with a Parker wiper minimizes fluid leakage and maximizes contamination exclusion. Our rod seals are designed with knife-trimmed lips to ensure the best possible film breaking. This dry rod technology permits the wiper to be extremely aggressive, excluding contamination without building up oil leakage around the wiper. Another systems approach to effectively control leakage is to incorporate multiple sealing lips. Parker's BR buffer ring, BT u-cup and AH double-lip canned wiper are designed to work together to give optimized performance and the driest sealing available in the industry (see Figure 2-2).

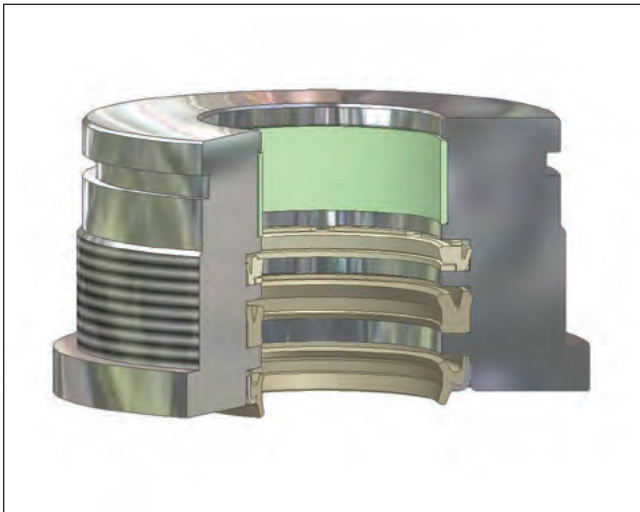

Figure 2-2. BR, BT, AH sealing system for leakage control

Even when appropriate seals are specified, it is still possible to experience leakage due to factors extending beyond the seals themselves. Examples are hardware considerations like surface finish, installation damage, seal storage, chemical wash downs, maintenance and contamination. Adhering to the design recommendations found herein not only for seals, but also for the mating hardware will provide the greatest likelihood of minimized leakage.

Lip vs. Squeeze Seals

The cross-sectional shape of a seal dramatically affects how it functions, especially at low pressure. The greatest trade-off in dynamic sealing is low friction performance vs. low pressure sealability. At low pressure, friction, wear and sealing ability are affected by whether or not the seal is a lip or squeeze profile (see Figure 2-3). With this in mind, seals are often categorized as either "lip seals" or "squeeze seals," and many fall somewhere in between. Lip seals are characterized by low friction and low wear; however, they also exhibit poor low pressure sealability. Squeeze seals are characterized by just the opposite: high friction and high wear, but better low pressure sealability.

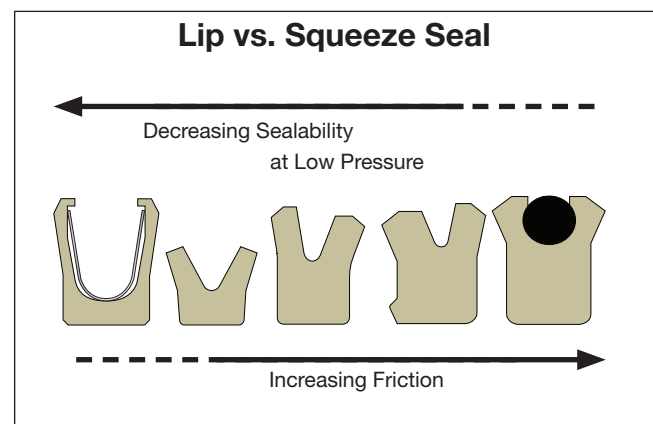

Figure 2-3. Lip seal vs. squeeze seal

As described above, a squeeze type seal will generate much more sealing force than a lip type seal. The assumption here is that both seals are under zero or low pressure. However, as fluid pressure increases, the differences between seal types become insignificant due to the force from the fluid pressure overcoming the designed squeeze. Pressure generally improves leakage control, but increases friction and its associated heat, wear and potential for extrusion.

In pneumatic applications, low friction is of the utmost importance. As such, lip seals are an excellent choice for these low pressure applications. Conversely, in hydraulic cylinders, where high system pressures easily overcome frictional forces, squeeze seals are often the appropriate choice. An example of a hydraulic application in which a squeeze seal would not be appropriate is a gravity returned hydraulic ram. In this case, a lip type hydraulic seal would generate lower friction, allowing the gravity return to function properly.

Effects of Lip Geometries

Lip geometry will determine several functions of the seal. Force concentration on the shaft, film breaking ability, hydroplaning characteristics and contamination exclusion are all factors dependent on lip shape. Table 2-1 shows four different lip shapes and provides helpful insights for choosing an appropriate lip geometry.

Table 2-1. Seal Lip Contact Shape

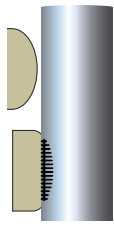
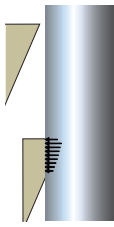
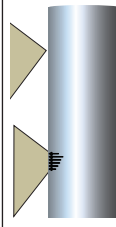
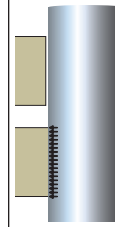
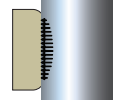
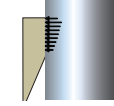
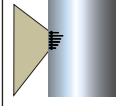
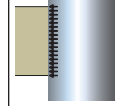
Contact Shape	Rounded	Straight Cut	Beveled	Square
Seal Lip Shape				
Shape of Contact Force/Stress Profile				
Film Breaking Ability	Low	High	Very High	Medium
Contamination Exclusion	Low	Very High	Low	High
Tendency to Hydroplane	High	Very Low	Low	Medium
Typical Uses	Pneumatic U-cups	Wipers and Piston Seals	Rod Seals	Piston Seals

Friction

Friction is a function of the radial force exerted by the seal and the coefficient of friction between the seal and the dynamic sealing surface. Reducing friction is generally desirable, but not always

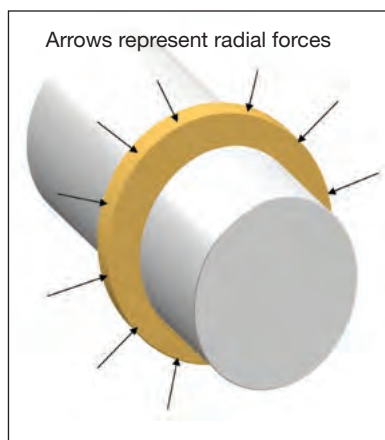

Figure 2-4. Radial force

necessary. Friction is undesirable because of heat generation, seal wear and reduced system efficiency.

Factors that affect the radial force are:

- Pressure
- Material modulus
- Temperature
- Lip geometry
- Squeeze vs. lip seal

Factors that affect the coefficient of friction are:

- Seal material
- Dynamic surface roughness
- Temperature
- Lubrication

When the proper seal selection is made, most seals will function such that friction is not a concern. However, when friction becomes critical, there are several ways to reduce it:

- Reduce the lip cross-section
- Decrease lip squeeze
- Change seal material
- Evaluate the hardware's surface finish
- Reduce system pressure
- Improve lubrication

Lowering friction increases seal life by reducing wear, increasing extrusion resistance, decreasing compression set and the rate of chemical attack.

Breakaway friction must be overcome for movement to begin. It is influenced by the duration in which an application remains stationary. The longer the duration, the more lubrication will be forced out from between the seal and the contacting surface. The seal material then conforms to the profile of the surface finish. These events increase breakaway friction.

Stick-slip is characterized by distinct stop-start movement of the cylinder, and may be so rapid that it resembles severe vibration, high pitched noise or chatter. Seals are often thought to be the source of the stick-slip, but other components or hardware can create this issue.

Causes of stick-slip include swelling of wear rings or back-up rings, extreme side-loading, valve pulsation, poor fluid lubricity, external sliding surfaces or seal pressure trapping. This condition can be puzzling or difficult to resolve. Possible causes and trouble-shooting solutions are listed in the following [Table 2-2](#).

Table 2-2. Stick-slip Causes and Troubleshooting Tips

Possible Causes	Troubleshooting Tips
Surface finish out of specification	Verify surface is neither too smooth or too rough
Poor fluid lubricity	Change fluid or use oil treatments or friction reducers
Binding wear rings	Check gland dimensions, check for thermal or chemical swell
Side loading	Review cylinder alignment, incorporate adequate bearing area
Seal friction	Use material with lower coefficient of friction
Cycle speed	Slow movement increases likelihood of stick-slip
Temperature	High temperature softens seals, expands wear rings, and can cause thermal expansion differences within hardware
Valve pulsation	Ensure valves are properly sized and adjusted
External hardware	Review system for harmonic resonance

Pressure Effects and Extrusion

Extrusion occurs when fluid pressure forces the seal material into the clearance gap between mating hardware. Dynamic motion further promotes extrusion, as surfaces in motion tend to pull material into the extrusion gap, generating additional frictional forces and heat. This can cause premature failure via several modes. Extruded seal material can break away and get caught underneath sealing lips, creating leak paths. As material continues to break away, seal geometry erodes, causing instability and eventual leakage. Additionally, heat generated from added friction will cause the seals to take a compression set, dramatically shortening their life.

Careful design considerations should be evaluated to prevent extrusion. For example, minimizing clearance gaps and selecting a proper material based on system temperature, pressure and fluid are both helpful in reducing the risk of extrusion. As



Figure 2-5. Extrusion damage

clearance gaps increase, less pressure is required in order for extrusion to occur. Higher temperatures can also play a role in this effect by causing seal materials to soften, encouraging extrusion at lower pressures. If the seal material chosen is not suitable to be used in the system fluid, softening due to chemical attack can also decrease its ability to resist extrusion.

The following Table 2-3 lists possible causes of extrusion and troubleshooting tips for preventative or corrective measures.

Table 2-3. Extrusion Causes and Troubleshooting Tips

Possible Causes
Large extrusion gaps
High operating temperature
Soft materials
High system pressure
Pressure spikes
Side loading
Wear rings
Chemical compatibility
Troubleshooting Tips
Reduce extrusion gaps
Check gland dimensions
Replace commercial grade wear rings with tight tolerance wear rings
Incorporate back-up rings
Evaluate size and positioning of wear rings for side load resistance
Consider harder, higher modulus and tensile strength compound
Match seal compound for pressure, temperature and fluid compatibility

By definition, the radial gap is one-half of the diametrical gap. The actual extrusion gap is often mistaken as the radial gap. This is too optimistic in most cases because side loading of the rod and piston will shift the diametrical clearance to one side. Often, gravity alone is sufficient for this to occur. Good practice is to design around worst case conditions so that extrusion and seal damage do not occur. Table 2-4 provides maximum *radial* extrusion gaps for various seal compounds.

As a general rule of thumb, the pressure rating of dynamic seals will be approximately one-half that of static seals.

Table 2-4. Typical Pressure Ratings for Standard Seal Compounds in Reciprocating Applications at +160°F (see Note)

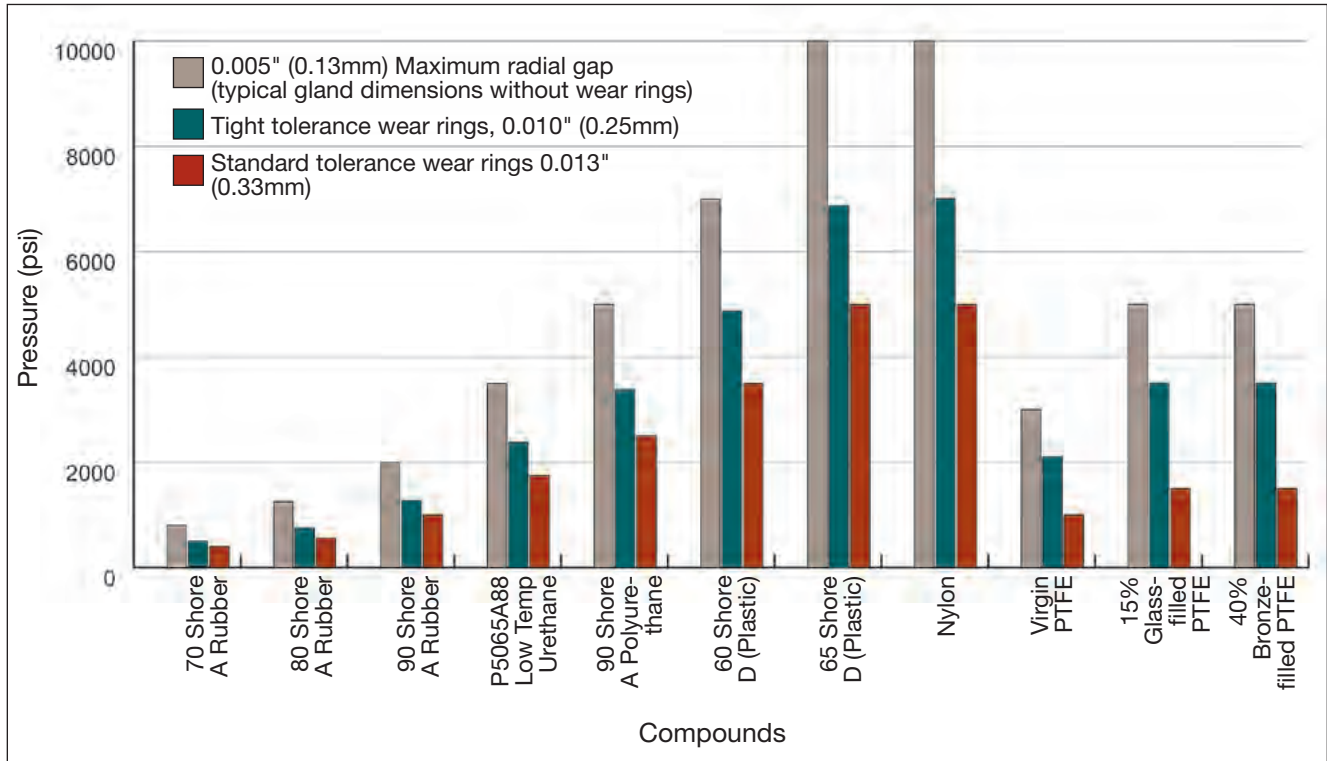

Note: Pressure ratings are based upon a test temperature of +160°F (+70°C). Lower temperatures will increase a material's pressure rating. Higher temperatures will decrease pressure ratings. Maximum radial gap is equal to the diametrical gap when wear rings are not used. Wear rings keep hardware concentric, but increase extrusion gaps to keep metal-to-metal contact from occurring, thereby decreasing pressure ratings when used.

As noted in Table 2-4, pressure ratings decrease when wear rings are used due to the larger extrusion gaps required to eliminate metal-to-metal contact. If wear rings are used, be sure to consult Section 9 (Wear Rings) and Section 10 (Back-ups) for appropriate hardware dimensions. Wear ring hardware dimensions for the piston and rod throat diameters always supersede those dimensions called out for the seals themselves.

Seal Wear

Seals will inevitably wear in dynamic applications, but with appropriate design considerations, this can be minimized. The wear pattern should be even and consistent around the circumference of the dynamic lip. A small amount of even wear will not drastically affect seal performance; however, if the wear patterns are uneven or grooved, or if the amount of wear is excessive, performance may be dramatically reduced. There are many factors that influence seal wear, many of which are described in the following Table 2-5.

Table 2-5. Factors Influencing Seal Wear

Factors that Influence Seal Wear	
Rough surface finish	Excessive abrasion may occur above 12 µin Ra
Ultra smooth surface finish	Surface finishes below 2 µin Ra can create aggressive seal wear due to lack of lubrication
High pressure	Increases the radial force of the seal against the dynamic surface
High temperature	While hot, materials soften, thus reducing tensile strength
Poor fluid lubricity	Increases friction and temperature at sealing contact point
Tensile strength of seal compound	Higher tensile strength increases the material's resistance to tearing and abrading
Fluid incompatibility	Softening of seal compound leads to reduced tensile strength
Coefficient of friction of seal compound	Higher coefficient materials generate higher frictional forces
Abrasive fluid or contamination	Creates grooves in the lip, scores the sealing surface and forms leak paths
Extremely hard sealing surface	Sharp peaks on hard surfaces will not be rounded off during normal contact with the wear rings and seals, accelerating wear conditions

06/01/2014

Seal wear may be indicated by flattening out of the contact point, or, in extreme circumstances, may appear along the entire dynamic surface as shown in Figure 2-6.

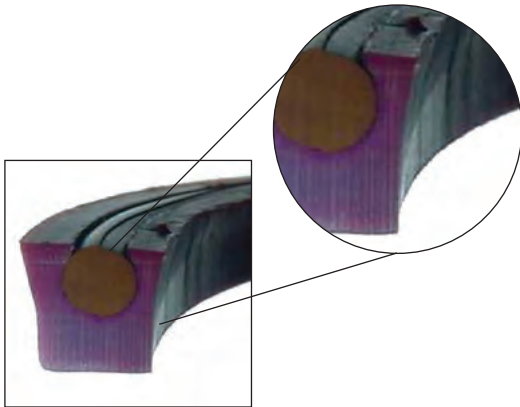

Figure 2-6. Seal wear on dynamic surface

Seal Stability

Dynamic stability is integral to a seal's performance, allowing the lip to effectively contact the sealing surface, eliminating rocking and pumping effects and promoting an even wear pattern at the sealing contact point. Instability can create leakage and seal damage. A typical instability malfunction known as "spiral failure" can occur when o-rings are used in reciprocating applications. Due to frictional forces that occur while the system is cycling, the o-ring will tend to roll or twist in the groove, causing leakage and even possible breakage. A square geometry will tend to resist this better than a round profile, but is not impervious to instability failure. Rectangular geometries provide the best stability in dynamic applications.

Other less obvious factors that influence the stability of a seal are:

- Percent gland fill
- Hardness or stiffness of the seal material



Fig. 2-7. Instability failure of a square profile piston seal

- Rough surfaces which create high friction
- Cross-section (larger is better)
- Design features of a seal (i.e. stabilizing lip, non-symmetrical design). Figure 2-8 illustrates how design features can make a seal more stable. In the first FEA plot, the seal is centered in the gland and does not incorporate a stabilizing lip. In the second plot, the seal is loaded against the static gland and includes a stabilizing lip. Stability has been enhanced by the design changes.

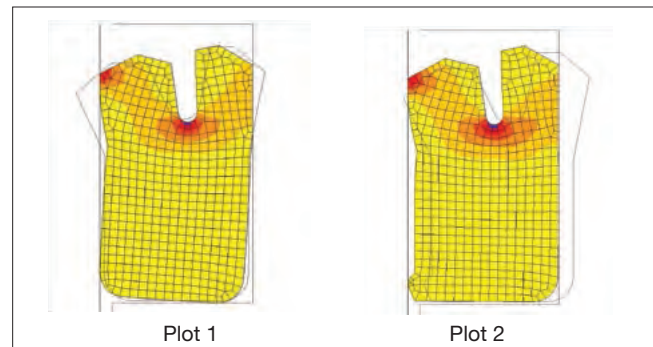

Figure 2-8. Design improvements for increased stability

Surface Speed

The surface speed of a reciprocating shaft can affect the function of a seal. Hydroplaning and frictional heat may occur with excessive speed, while stick-slip, discussed previously in the friction section, is most often associated with slow speed.

Hydroplaning occurs when hydrodynamic forces lift the sealing lip off of the dynamic surface, allowing fluid to bypass the seal. The lip geometry, as well as the overall force on the lip, will influence its ability to resist hydroplaning. Most hydraulic seals are rated for speeds up to 20 inches/second (0.5 m/second), but this may be too fast for certain lip geometries or when the seal has a lightly loaded design. Table 2-1 on page 2-3 shows which lip geometries are subject to hydroplaning. Straight cut and beveled lip geometries are the most effective at resisting hydroplaning so long as sufficient lip loading is present to overcome the hydrodynamic forces.

High surface speeds can create excessive frictional heat. This can create seal problems when the dynamic surface is continuously moving. The under-lip temperature of the seal will become much hotter than the system fluid temperature, especially when the seal is under pressure. If the heat being generated cannot be dissipated, the seal will experience compression set, wear, extrusion and/or increased chemical attack.

Compression Set

Compression set is the inability of a seal to return to its original shape after being compressed. As defined by ASTM, it is the percent of deflection by which the seal fails to recover after a specific deflection, time and temperature. Compression set is calculated using the following equation:

$$\text{Compression Set} = \frac{H_i - H_R}{H_i - H_C} \times 100$$

where

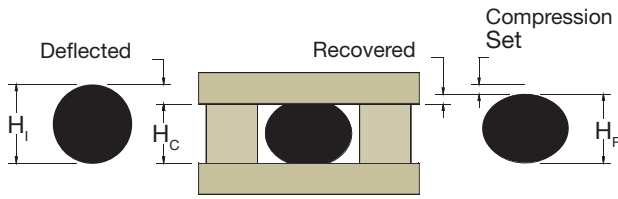

H_i = Initial height

H_c = Compressed height

H_r = Recovered height

Compression set reduces sealing forces, resulting in poor low pressure sealability. It takes place primarily because of excessive exposure to a high temperature. A material's upper end temperature limit may give an indication of its compression set resistance. Although compression set always reduces the seal's dimensions, chemical swell or shrinkage can either positively or negatively impact the final geometry of the seal. If material shrinkage occurs due to the system fluid, the deflection of the seal will decrease, accelerating leakage. If chemical swell is present, it can negate or offset the negative effects of compression set. While it is true that swelling can offset compression set, extreme fluid incompatibility can break down the polymer's chemical structure and cause the material to be reformed in its compressed state. (See also [page 3-9](#).)

Lip wear is also a dimensional loss, but is not related to compression set. Dimensional loss due to lip wear will increase the final compression set value.

The seal shown in Figure 2-9 exhibits nearly 100% compression set with minimal wear. Note how the lips flare out very little.

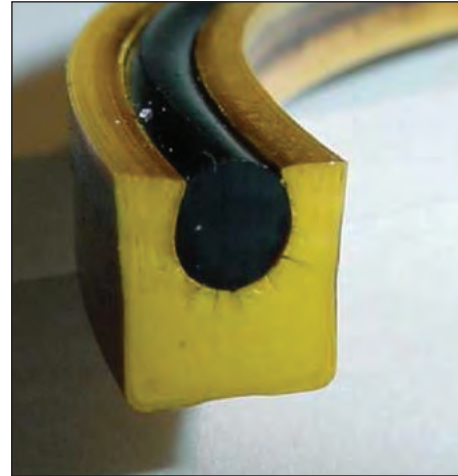

Figure 2-9. Seal exhibiting nearly 100% compression set

Influence of Temperature

All seal materials have a specified operating temperature range (see Section 3, Materials). These temperatures are provided as guidelines and should not be used as specification limits. It is wise practice to stay well within this range, knowing that physical properties are severely degraded as either limit is approached.

Temperature affects extrusion, wear, chemical resistance and compression set, which ultimately influences the sealing ability of a product. High temperatures reduce abrasion resistance, soften materials, allowing them to extrude at lower pressures, increase compression set and can accelerate chemical attack. Low temperatures can cause materials to shrink and harden, reducing resiliency and sealability. Some of these problems can be solved by using low temperature expanders

or metal springs as a component of the seal selection (see [Section 3, Materials](#)).



Figure 2-10. Progressive effect (hydrolysis) of high temperature water on standard urethane seals (yellow) vs. Parker Resilon® 4301 polyurethane seals (aqua).

06/01/2014

General Guidelines for Hardware Design

For easy assembly and to avoid damage to the seal during assembly, Parker recommends that designers adhere to the tolerances, surface finishes, leading edge chamfers and dimensions shown in this catalog.

Table 2-6.

Installation Chamfer, Gland Radius, and Taper		
Seal Cross Section	"A" Dimension	"R" Dimension
1/16	0.035	0.003
3/32	0.050	0.015
1/8	0.050	0.015
5/32	0.070	0.015
3/16	0.080	0.015
7/32	0.080	0.015
1/4	0.080	0.015
9/32	0.085	0.015
5/16	0.085	0.015
11/32	0.085	0.015
3/8	0.090	0.015
13/32	0.095	0.015
7/16	0.105	0.030
15/32	0.110	0.030
1/2	0.120	0.030
17/32	0.125	0.030

Installation Chamfer, Gland Radius, and Taper		
Seal Cross Section	"A" Dimension	"R" Dimension
9/16	0.130	0.030
19/32	0.135	0.040
5/8	0.145	0.040
21/32	0.150	0.040
11/16	0.160	0.040
23/32	0.165	0.040
3/4	0.170	0.040
25/32	0.180	0.060
13/16	0.185	0.060
27/32	0.190	0.060
7/8	0.200	0.080
29/32	0.205	0.080
15/16	0.215	0.080
31/32	0.220	0.080
1	0.225	0.080

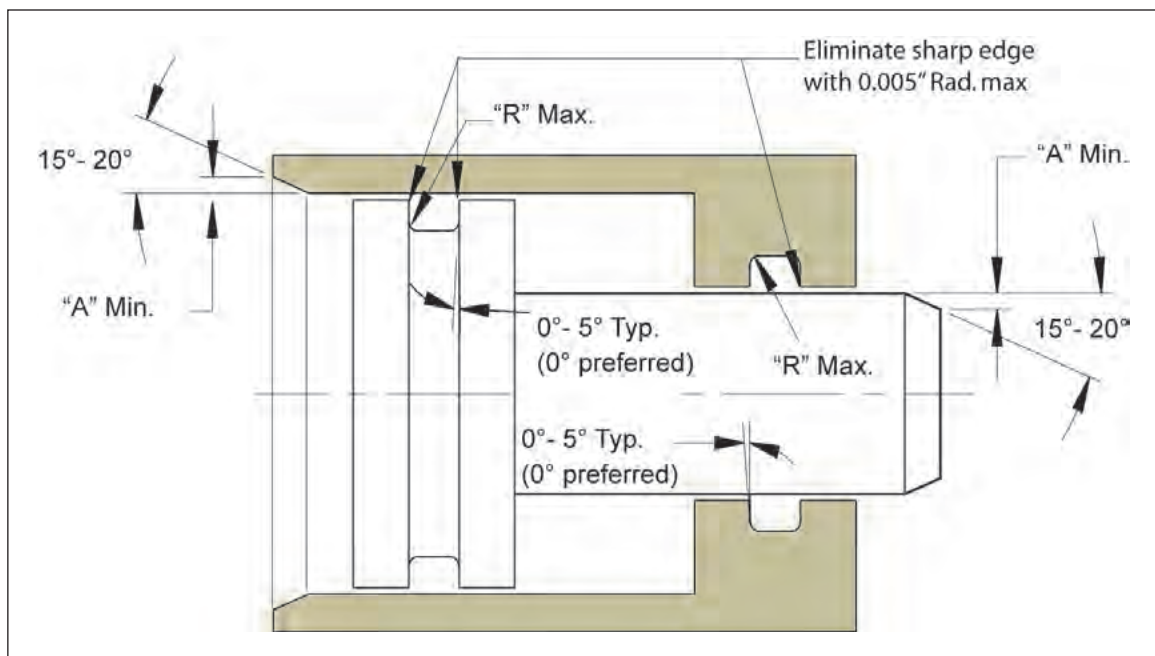

Figure 2-11.

Hardware Surface Finish

Understanding and applying the benefits of appropriate surface finish specifications can dramatically affect the longevity of a sealing system. In a dynamic surface, microscopic variations form recesses which hold an oil film between the seal lip and the moving surface. If the surface is too smooth, friction and seal wear will be high because this oil film will not be present. If the surface is too rough, the variations will create leak paths and accelerate lip wear. For these reasons, it is critical to have an in depth understanding of surface finishes as they pertain to dynamic sealing systems. As such, Parker recommends following the guidelines for surface finish as outlined below or conducting individual testing for specific applications to validate seal function and expected life.

Over the years, greater attention has been given to this subject as realizations about warranty savings and system life become more prevalent. As equipment required to measure and maintain a proper surface finish has evolved and improved, the subject of surface finish has become more complex. Traditional visual inspection gauges are no longer sufficient to effectively measure surface finish. Profilometers are now commonly used to achieve precise measurements with repeatable results. In the same way, the terms used to define a surface finish have also advanced.

For many years, a single surface parameter has often been used to quantify surface finish. RMS (also known as Rq) stands for Root Mean Square and has historically been the most typical value. In more recent years, the Arithmetic Average Roughness, Ra, has become more frequently specified. Using either of these parameters by itself is inadequate to define a proper reciprocating sealing surface. Figure 2-12 depicts why this parameter alone cannot accurately describe a surface finish.

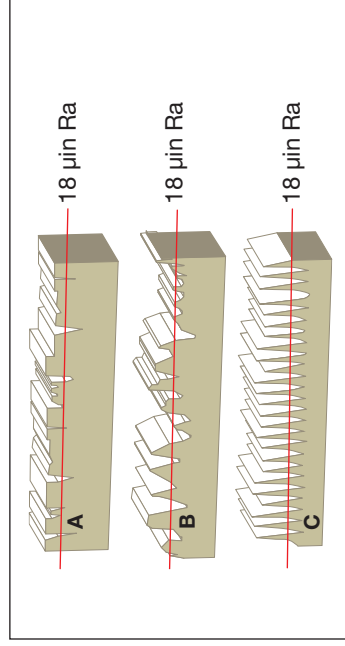

Figure 2-12. Different surface finishes yielding same Ra value

The three surface finishes shown in Figure 2-12 all have the same Ra value but very unique characteristics.

The first profile (A) is an example of a proper surface finish for dynamic seals in which the sharp peaks have been minimized or removed. The second profile (B) will exhibit high wear characteristics because of the wide spacing between the peaks. The third profile (C) will also wear out the seals quickly because of its extremely sharp peaks.

Ra is sufficient to define the magnitude of surface roughness, but is insufficient to define a surface entirely in that it only describes the average deviation from the mean line, not the nature of the peaks and valleys in a profile. To obtain an accurate surface

description, parameters such as Rp, Rz and Rmr (tp) can be used to define the relative magnitude of the peaks and the spacing between them. These parameters are defined in Table 2-7, and their combination can identify if a surface is too rough or even too smooth for reciprocating applications.

There are other parameters that can be considered for surface finish evaluation. For example, the limitation of Rt is that it considers only one measurement, while Rz, Rp and Rmr consider the full profile.

RMS = Rq. The Root Mean Square (RMS) as defined by ISO 4287:1997 and other standards is often defined as Rq. These terms are interchangeable.

Rq ≠ Ra. Confusion has typically existed regarding these values, leading to misconceptions that they are interchangeable. Rq and Ra will never be equal on typical surfaces. Another misconception is that there is an approximate 11% difference between the two. Ground and polished surfaces can have Rq values that are 20 to 50 percent higher than Ra. The 11% difference would only occur if the surface being measured took the form of a true sine wave. A series of tests conducted at Parker has shown Rq to be 30% higher than Ra on average.

What's the Significance?

Specifications previously based on a maximum surface finish of 16 µin RMS for ground and polished rods should specify a maximum finish of **12 µin Ra**.

Table 2-7. Roughness Parameter Descriptions

Parameter Descriptions

Roughness parameters are defined per ISO 4287:1997 and ISO 4288:1996.

Ra* – Arithmetic average or mean deviation from the center line within a sampling length.

Rq* – Root mean square deviation from the center line within a sampling length.

Rp* – Maximum profile peak height within a sampling length. Also known as Rpm in ASME B46.1 – 2002.

Rv* – Maximum profile valley depth within a sampling length. Also known as Rvm in ASME B46.1 – 2002.

Rz* – Maximum height of profile within a sampling length ($Rz = Rp + Rv$).

NOTE: ISO 4287:1984, which measured five peaks and five valleys within a sampling length, is now obsolete. This value would be much lower because additional shorter peaks and valleys are measured. Over the years there have been several Rz definitions used. Care needs to be taken to identify which is used.

Rt – Maximum height of the profile within the evaluation length. An evaluation length is typically five sampling lengths.

Rmr – Relative material ratio measured at a given height relative to a reference zero line. Indicates the amount of surface contact area at this height. Also known as tp (bearing length ratio) in ASME B46.1 – 2002.

*Parameters are first defined over a sampling length. When multiple sampling lengths are measured, an average value is calculated, resulting in the final value of the parameter. The standard number of sampling lengths per ISO 4287:1997 and ISO 4288:1996 is five.

Figure 2-13 graphically represents Ra. The shaded area, which represents the average height of the profile, Ra, is equal to the area of the hatched portion. The mean line, shown in red, splits the hatched area in half and forms the center line for Ra. The graph also shows Rq, which is higher than Ra.

Figure 2-14 shows the actual surface profile of a polished chrome rod.

Upon examination of the profile, it can be seen that the polishing operation has removed or rounded the peaks producing a positive affect on the characteristics of the sealing surface, as described below by Ra, Rp, Rz and Rmr.

- Ra = 8.9 μ m
- Rp = 14.8 μ m (which is 1.7 x Ra, less than the 3x guideline)
- Rz = 62.9 μ m (which is 7.1 x Ra, less than the 8x guideline)
- Rmr = 74%

Figure 2-14 also illustrates how Rp and Rz are calculated using the following equations:

$$Rp = \frac{Rp1 + Rp2 + Rp3 + Rp4 + Rp5}{5}$$

$$Rz = \frac{Rz1 + Rz2 + Rz3 + Rz4 + Rz5}{5}$$

NOTE: In the profile shown in Figure 2-14, Rt = Rz2 because the tallest peak and deepest valley occur in the same sampling length.

Figure 2-15 considers the same surface and illustrates how the Rmr value of 74% is determined. To accomplish this, locate the height of the curve at 5% material area (this is the reference line or “zero line”). From this height, move down a distance of 25% Rz and locate the new intersection point along the curve. This new intersection point is the actual Rmr value of 74%.

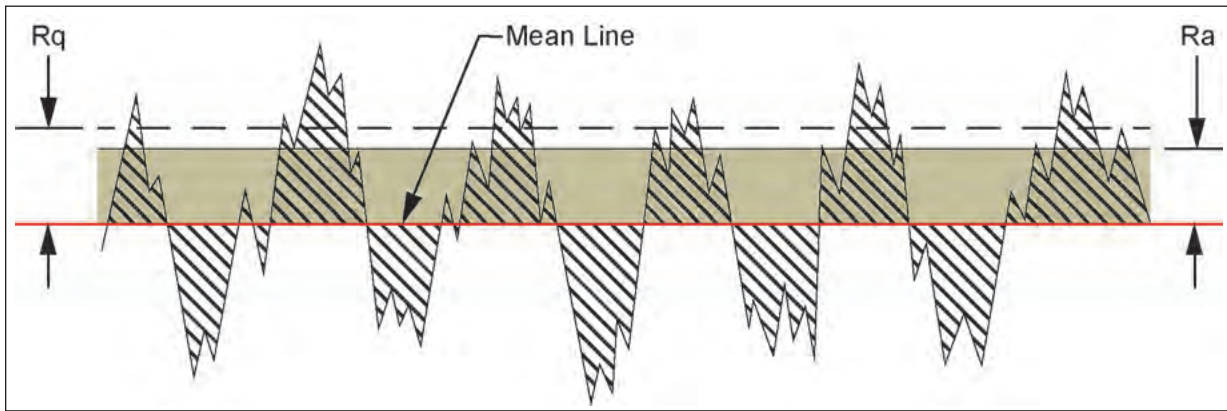

Figure 2-13.

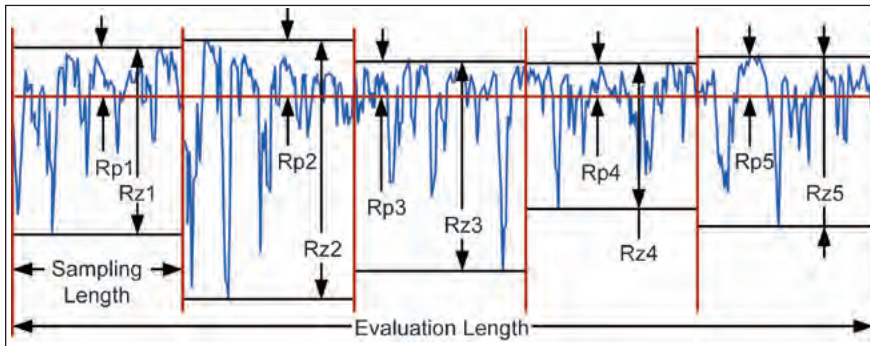

Figure 2-14.

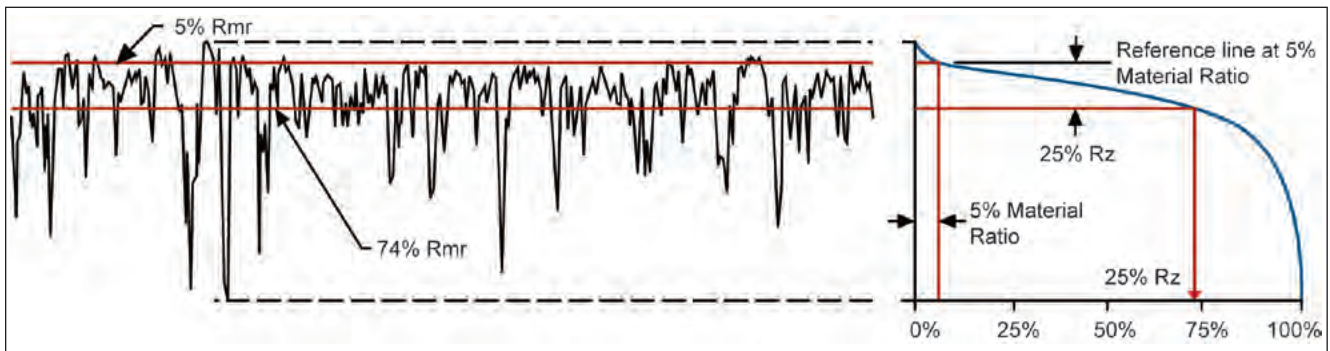

Figure 2-15.

Surface Finish Guidelines for Reciprocating Seals

Recommendations for surface roughness are different for static and dynamic surfaces. Static surfaces, such as seal groove diameters, are generally easier to seal and require less stringent roughness requirements; however, the type of fluid being sealed can affect the guidelines (see Table 2-8). It is important to remember that surface finish recommendations will vary depending upon the seal material of choice. PTFE seals require smoother finishes than seals made from polyurethane and most rubber compounds.

Four parameters have been selected to define a proper surface finish for hydraulic and pneumatic reciprocating applications. These parameters are Ra, Rp, Rz and Rmr. For descriptions of these parameters, please consult Table 2-8.

Grinding as a final process for dynamic sealing surfaces is rarely sufficient. In order to obtain an acceptable Rmr value, the surface must often be ground and polished. If the surface is not polished in addition to being ground, the ratio of Rp and Rz to Ra will be too high or Rmr ratio too low.

Table 2-8. Surface Finish Guidelines

Ra Guidelines				
Application	Thermoplastic and Rubber Seals		PTFE Seals	
	Dynamic Surfaces	Static Surfaces	Dynamic Surfaces	Static Surfaces
Cryogenics	—	—	4 µin (0.1 µm) maximum	8 µin (0.2 µm) maximum
Helium Gas Hydrogen Gas Freon	3 to 10 µin (0.08 to 0.25 µm)	12 µin (0.3 µm) maximum	6 µin (0.15 µm) maximum	12 µin (0.3 µm) maximum
Air Nitrogen Gas Argon Natural Gas Fuel (Aircraft and Automotive)	3 to 12 µin (0.08 to 0.3 µm)	16 µin (0.4 µm) maximum	8 µin (0.2 µm) maximum	16 µin (0.4 µm) maximum
Water Hydraulic Oil Crude Oil Sealants	3 to 12 µin (0.08 to 0.3 µm)	32 µin (0.8 µm) maximum	12 µin (0.3 µm) maximum	32 µin (0.8 µm) maximum
Rp Guidelines				
Application	Thermoplastic and Rubber Seals		PTFE Seals	
	Dynamic Surfaces	Static Surfaces	Dynamic Surfaces	Static Surfaces
All media/fluids	If Ra ≥ 5 µin (0.13 µm), then Rp ≤ 3 × Ra	—	If Ra ≥ 5 µin (0.13 µm), then Rp ≤ 3 × Ra	—
	If Ra < 5 µin (0.13 µm), then Rp ≤ 3.5 × Ra		If Ra < 5 µin (0.13 µm), then Rp ≤ 3.5 × Ra	
	Example: If Ra = 4 µin, then Rp ≤ 14 µin.			
Rz Guidelines				
Application	Thermoplastic and Rubber Seals		PTFE Seals	
	Dynamic Surfaces	Static Surfaces	Dynamic Surfaces	Static Surfaces
All media/fluids	Rz ≤ 8 × Ra and 70 µin (1.8 µm) maximum	Rz ≤ 6 × Ra	Rz ≤ 8 × Ra and 64 µin (1.6 µm) maximum	Rz ≤ 6 × Ra
	Example: If Ra = 4 µin, then Rz ≤ 32 µin (dynamic calculation)			
	Note: Rz values above maximum recommendations will increase seal wear rate.			
Rmr Guidelines				
Application	Thermoplastic and Rubber Seals		PTFE Seals	
	Dynamic Surfaces	Static Surfaces	Dynamic Surfaces	Static Surfaces
All media/fluids	45% to 70% (thermoplastic)	—	60% to 90%	—
	55% to 85% (rubber materials)			
	Rmr is measured at a depth of 25% of the Rz value based upon a reference level (zero line) at 5% material/bearing area.			

Surface Finish FAQs

How can a dynamic surface finish be too smooth?

There are two areas of concern that have been observed on extremely smooth surfaces, the first being seal wear, the second being leakage. When surface finishes have been measured at or below 1 µin Ra, an extremely accelerated seal wear rate has been observed. A small jump to 1.8 to 2 µin Ra shows significant improvement, indicating that the extremely low range should be avoided. With higher values showing even greater life extension, the optimal range for Ra has been determined to be 3 to 12 µin.

Regarding leakage, some seal designs that function well with 6 to 12 µin Ra finishes begin to leak when the finish falls below 3 µin Ra. Due to technological advances, there are many suppliers who manufacture rods with finishes this smooth. It is always necessary to validate seal performance, especially if using an ultra-smooth dynamic surface.

What is the difference between RMS (Rq) and Ra?

RMS which stands for Root Mean Square (and now known as Rq), is one way of quantifying the average height of a surface. The Arithmetic Average, Ra, quantifies the surface in a different manner, providing a true mean value. These parameters will almost always be different, but there is not an exact relationship between the two for a typical sealing surface of random peaks and valleys. If a surface were to perfectly resemble a sine wave, the result would place the RMS value 11% higher than Ra, but this is not a very realistic scenario. On various ground and polished surfaces, RMS has been observed to be as much as 50% higher than Ra, but on average, runs about 30% higher. If this 30% average difference is applied to a 16 µin RMS specification, the maximum recommended value would be 12 µin Ra.

Why are Rp and Rz specified as a function of Ra, and not simply a range?

Take a shaft with the minimum recommended value of Ra = 3 µin, for example. Using the formula for Rz, the maximum value would be calculated as 24 µin (8 x 3). If the requirement simply stated a range that allowed Rz values up to 70 µin, this large difference indicates that the surface profile could have many large, thin surface peaks which would abrade the seal quickly. By the same regard, a maximum Ra value of 12 µin would result in an Rz value of 96 µin (12 x 8), which is beyond the recommended maximum value of 70 µin. The same principle applies for Rp: peaks should be removed to reduce seal wear via a polishing process. Grinding without polishing can leave many abrasive surface peaks.

Why is Ry (also known as Rmax) not used in Parker's roughness specification?

Ry only provides a single measurement (a vertical distance from one peak to valley) within the whole evaluation length. In actuality, there may be several peaks and valleys of similar height, or there may only be one large peak or valley. Rp and Rz provide much more accurate results, showing the average of five peak to valley measurements (one measurement in each of the five sampling lengths). Furthermore, ISO 4287:1997 and ISO 4288:1996 standards no longer incorporate the use of Ry.

When does a dynamic surface finish become too rough?

Although it is possible for some seals to function when running on rough finishes, there are always concerns with accelerated wear and leakage control. Certain seals have been able to function at 120 µin Ra finishes for short periods of time, but seal life in these cases can be reduced up to five or six times. On the contrary, some seals have failed at surface finishes as low as 16 µin Ra when pressure was insufficient to effectively energize the sealing lips as they rapidly wore out. Even though a rough finish is not a guaranteed failure mode, it is always best to stay within the recommended specifications. Remember that a proper finish also meets the recommendations for Rp, Rz and Rmr listed in the surface roughness guidelines.

Installation

2

Considerations

Installation techniques may vary considerably from case to case, depending on whether a seal is being replaced as a maintenance procedure or being installed in the original manufacture of reciprocating assemblies. Variations also arise from differences in gland design. A two-piece, split gland design, although rarely used, poses fewer problems than a “snap-in” groove positioned deep inside the body of a long rod gland. In production situations, or where frequent maintenance of similar or identical assemblies is performed, it is customary to utilize special tools to permit fitting a seal into its groove without overstressing it or subjecting it to nicks and cuts during insertion.

The common issues associated with all installation procedures are:

- 1. Cleanliness.** The seal and the hardware it must traverse on its way into the groove, as well as the tools used to install the seal, must be cleaned and wiped with lint-free cloths.
- 2. Nick and Cut Protection.** Threads, sharp corners and burrs can damage the seal. Care should be taken to avoid contact with these surfaces. Burrs must be removed, sharp corners should be blunted or radiused, and threads should be masked or shielded with special insertion tooling (see Figure 2-16). Although it is good practice to take extra care in the handling and manipulation of the seal, this is seldom sufficient and it usually requires either a safety tool or masking to protect the seal against such damage.

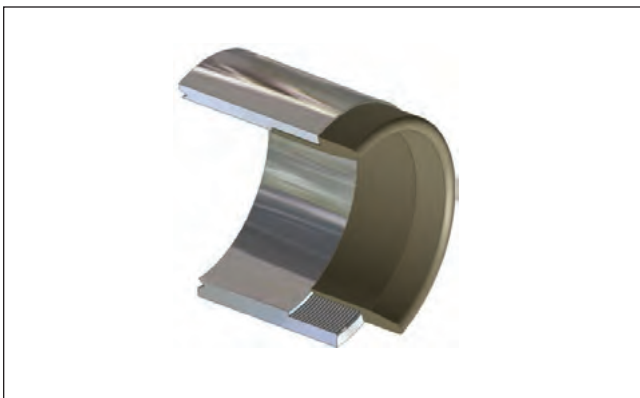

Figure 2-16. Thread protection installation tool cutaway view

- 3. Lubrication.** Both the seal and its installation path must be lubricated prior to insertion. The lubricant should be selected for its compatibility with the seal compound and the working fluid it will later encounter. Often, the working fluid itself can be used as the lubricant (see Table 2-9).

Table 2-9. Seal Installation Lubricants

Type	Temp. Range °F (°C)	Seal Use	Seal Material Compatibility
Petroleum base (Parker O Lube)	-20 to +180 (-29 to +82)	Hydrocarbon fluids; Pneumatic systems under 200 psi	Molythane®, Resilon®, Polymyte®, Nitroxile®, HNBR, NBR, FKM, (DO NOT use with EPR)
Silicone grease or oil (Parker Super O Lube)	-65 to +400 (-54 to +204)	General purpose; High pressure pneumatic	Molythane, Resilon, Polymyte, Nitroxile, HNBR, NBR, EPR, FKM
Barium grease	-20 to +300 (-29 to +149)	Pneumatic systems under 200 psi	Molythane, Resilon, Polymyte, Nitroxile, HNBR, NBR, FKM
Fluorocarbon fluid	-65 to +400 (-54 to +204)	Oxygen service	EPR

- 4. Lead-in Chamfer.** A generous lead-in chamfer will act as a guide to aid in seal installation. With the proper lead-in chamfer, the seals can be installed without lip damage. Refer to Figure 2-17 below and Table 2-6 on page 2-8 for proper lead-in chamfer dimensions.

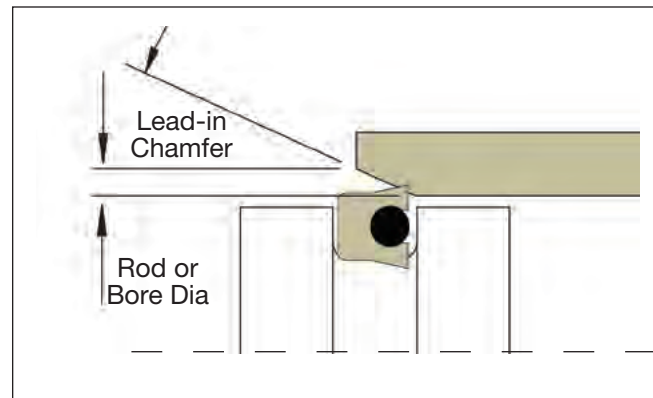

Figure 2-17. Seal installation lead-in chamfer

5. Heating. Where harder or fabric-reinforced compounds are used in snap-in applications, elasticity of the seal may fall short of that required for stretching or compressing onto (or into) the groove. Since seal compounds characteristically exhibit a high thermal coefficient of expansion, and tend to soften somewhat when heated, it is sometimes possible to “soak” the seals in hot lubricant to aid installation. Be sure to observe the compound temperature limits, and avoid heating the seals while stretched. Heating a seal while stretched will invoke the Gow-Joule effect and actually shrink the seal.

6. Cross Section vs. Diameter. Care must be taken to properly match a seal's cross-section to its diameter. If the cross-section is too large in relation to the diameter, it will be difficult to snap-in or stretch the seal into the groove. This condition is typically only associated with polyurethane, Polymyte® and other high modulus materials. The data shown in Table 2-10 may be used as a guide to determine this relationship for ease of installation.

Table 2-10. Seal Cross Section vs. Diameter Installation Guide

Cross Section	Installation Guide Cross Section vs. Diameter			
	Minimum Diameter Rod Seal		Minimum Diameter Piston Seal	
	Poly-urethane	Polymyte	Poly-urethane	Polymyte
1/8"	.750 I.D.	1.000 I.D.	1.250 I.D.	1.750 I.D.
3/16"	1.000 I.D.	1.750 I.D.	1.750 I.D.	2.750 I.D.
1/4"	1.750 I.D.	2.750 I.D.	3.000 I.D.	4.500 I.D.
3/8"	3.000 I.D.	5.000 I.D.	6.000 I.D.	8.000 I.D.
1/2"	6.000 I.D.	8.000 I.D.	10.000 I.D.	12.000 I.D.
3/4"	8.000 I.D.	9.000 I.D.	15.000 I.D.	17.000 I.D.
1"	10.000 I.D.	10.000 I.D.	20.000 I.D.	25.000 I.D.

7. Installation Tools. Use installation tools as recommended (see pages 2-16 and 2-17).

8. Itemize and Use a Check List. All components required to complete a sealing assembly should be itemized and checked off as they are installed. The absence of any single component can cause the entire system to fail.

**Installation Tools —
Piston Seals**

The installation of piston seals can be greatly improved with the use of installation tooling. Tooling not only makes the installation easier, but also safer and cost effective for high volumes as seals are less likely to be damaged when using proper tooling. For piston seal installation using tooling, use the following steps:

1. Inspect all hardware and tooling for any contamination, burrs or sharp edges. Clean, debur, chamfer, or radius where necessary. Make sure the piston and groove are undamaged.
2. If using a two-piece energized cap seal, install the o-ring or rubber energizer into the groove per vendor specifications.
3. Install the expanding mandrel onto the piston (Figure 2-18).
4. Light lubrication and/or warming (+140°F max) may aide installation. Use system compatible lubricant only.
5. Place the seal onto the expanding mandrel, and using hand pressure or a pusher, if necessary, gently push the seal along the taper until it snaps into place (Figure 2-19).

6. If back-up rings are to be used, install split versions into their proper location or use the mandrel method in Step 5 for non-split rings.
7. For PTFE cap seals, slide the resizing tool over the seal to compress the seal to its original diameter (Figures 2-20, 2-21).

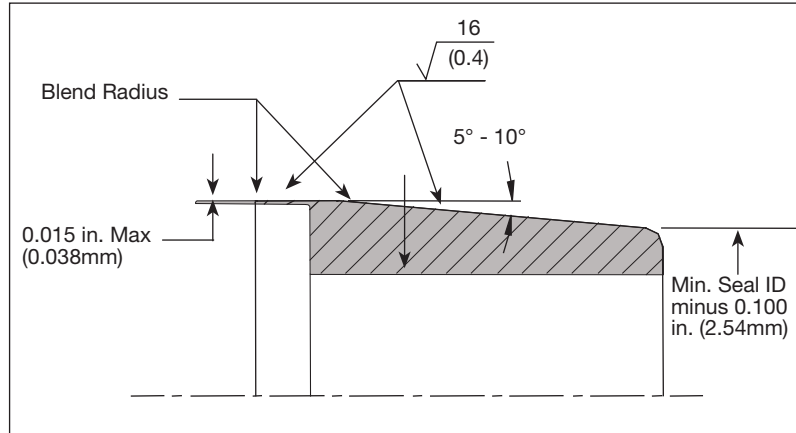

Figure 2-18. Expanding mandrel

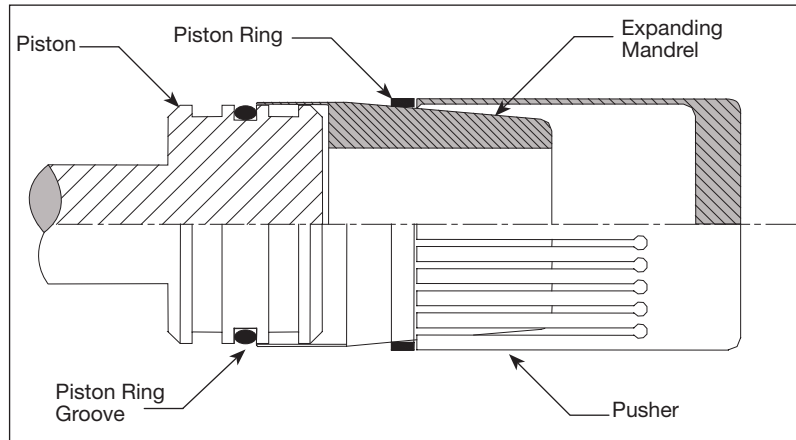

Figure 2-19. Installation of piston seal with tooling

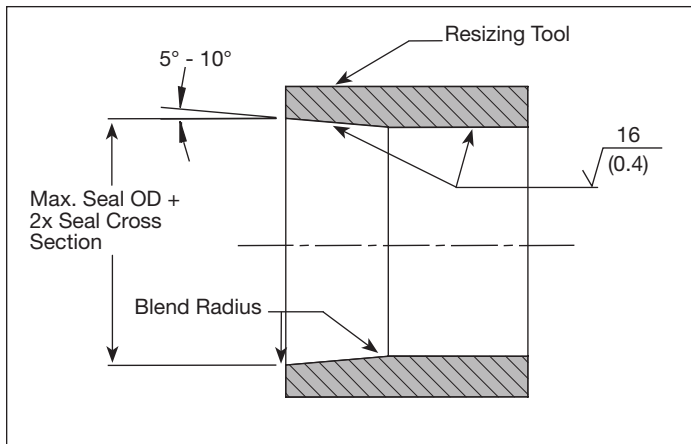

Figure 2-20. Resizing tool

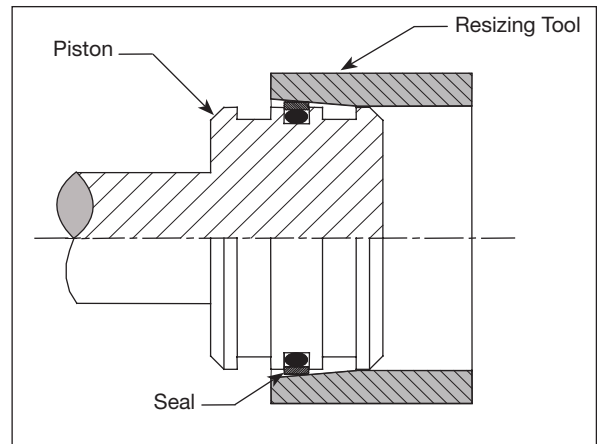

Figure 2-21. Resizing

Installation Tools – Rod Seals

Many rubber, plastic and PTFE rod seals can be manipulated by hand for installation into the seal groove. Small diameter parts or parts with large cross sections may require a two piece (split) groove for installation. Special tooling can be utilized to help the installation process; however, PTFE and Polymyte® seals in particular require caution to ensure the sealing component is not nicked, dented or damaged. The following guidelines provide the steps for proper rod seal installation. If needed, please call your local Parker representative for recommendations.

1. Inspect all hardware and tooling for any contamination, burrs or sharp edges. Clean, debur, chamfer or radius where necessary. Make sure the bore, groove and rod are undamaged.
2. If using a two-piece, energized cap seal, first carefully install the o-ring or rubber energizer into the groove to ensure proper seating.
3. By hand, gently fold the seal into a kidney shape (Figure 2-22) and install into the groove. For rubber and polyurethane seals, the use of a three-prong installation tool can be helpful for folding the seal and installing it into the groove (Figure 2-23).
4. Unfold the seal into the groove, and using your finger, feel the inside diameter of the seal to make sure it is properly seated.
5. For PTFE seals, after unfolding the seal in the groove, use a resizing tool (Figure 2-24) to re-expand the seal.
6. If a back-up ring is to be used with the rod seal, position the seal toward the internal side of the groove to allow space for the back-up ring installation.

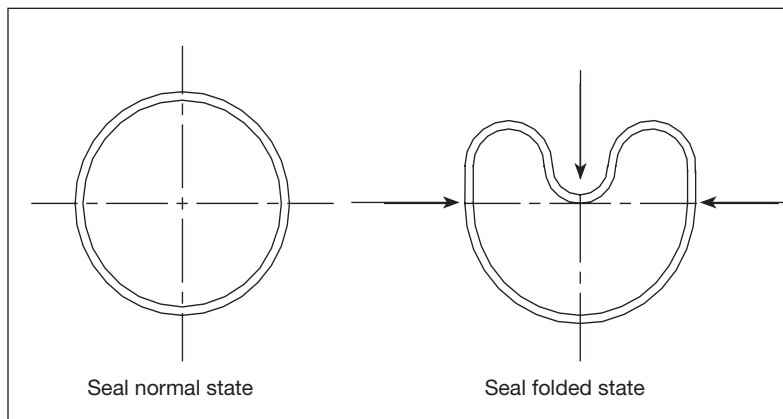

Figure 2-22. Rod seal folding

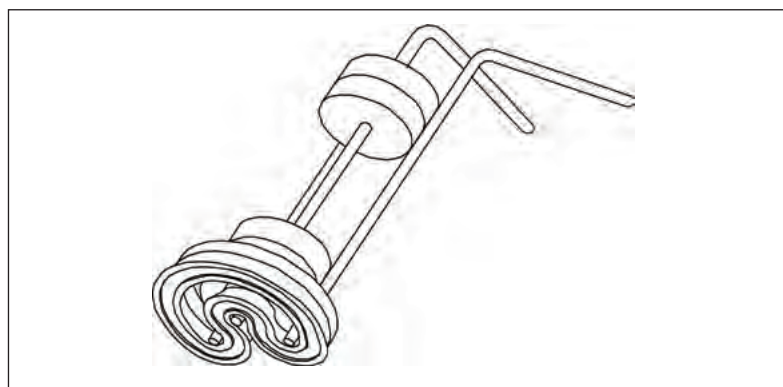

Figure 2-23. Three-leg installation tool for polyurethane and rubber seals

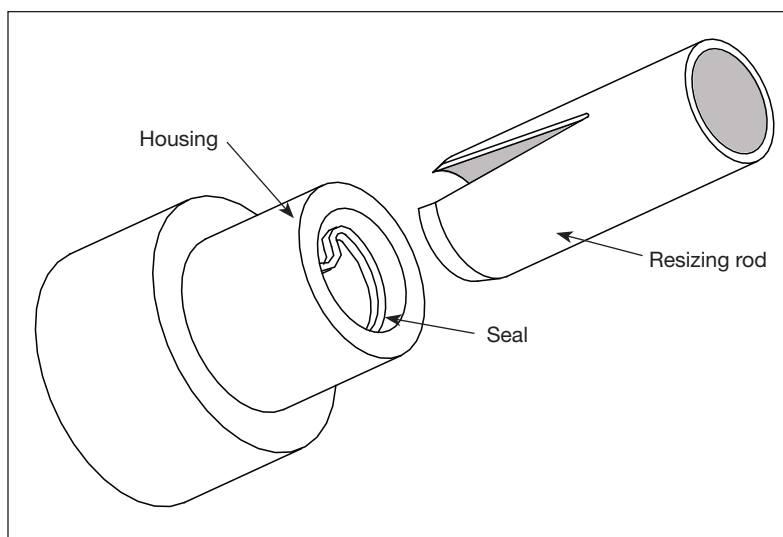

Figure 2-24. Rod seal installation

Finite Element Analysis

Finite Element Analysis (FEA) is a powerful computer simulation tool that allows engineers to evaluate product designs and materials and to consider "what if" scenarios in the development phase. FEA helps minimize time and cost by optimizing a design early in the process, reducing pre-production tooling and testing. Within the simulation program, the product being evaluated is divided into "finite elements," and model parameters such as pressure and seal lip squeeze are defined. The program then repeatedly solves equilibrium equations for each element, creating an overall picture of seal deformation, stress and contact forces (see Figure 2-25). These results can then be linked to application testing to predict performance.

Precise material characterization is an essential component of accurately modeling elastomeric products with FEA. Due to the complex nature of elastomers, multiple tests must be performed in order to determine their behavior under stress and strain. Figure 2-26 shows the typical nonlinear stress-strain curves for elastomers compared to the linear property of steel. These nonlinear complexities make performing FEA for elastomers much more difficult than for metal materials. Advances in material characterization are continually being made to improve the ability to capture and predict thermoviscoelastic effects of elastomers.

FEA results must be linked with lab and field testing to create a baseline to predict seal performance. Once this baseline is established, design iterations can be performed within FEA until the desired results are achieved and an optimum design

is predicted. This evaluation process enables engineers to anticipate the performance of new seal designs by minimizing the time and cost associated with prototype tooling investments (see Figure 2-27). Like any computer simulation, FEA has its limitations. The cost of performing FEA should always be justified by its results. FEA can provide relative information on leakage performance and wear life, but cannot give concrete answers to questions like, "Will this seal leak, and if so, how much?" and "How many cycles can be expected before failure occurs?"

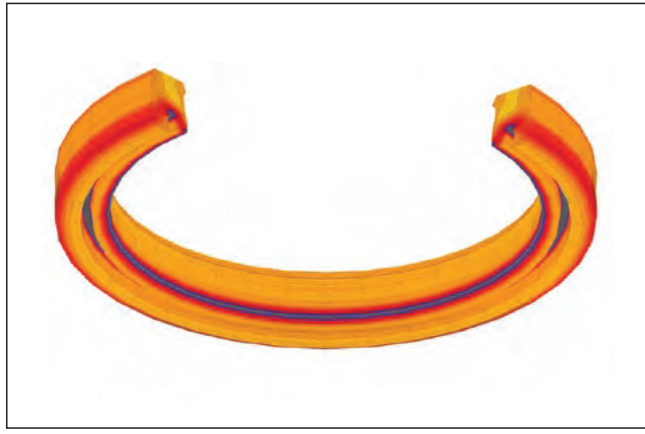

Figure 2-25.

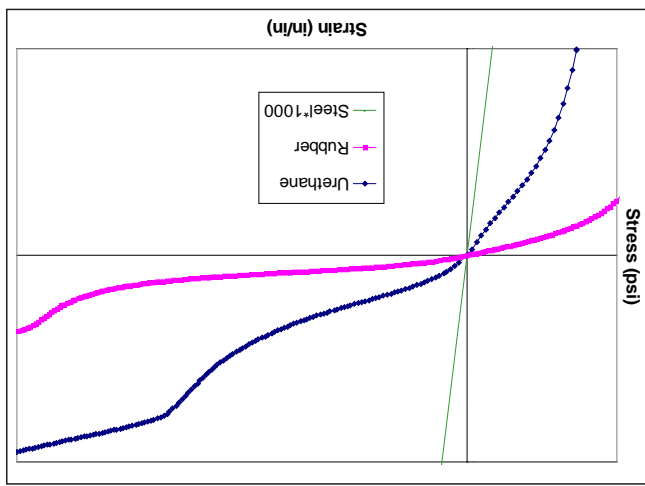

Figure 2-26. Stress/Strain relationship of steel vs. elastomers

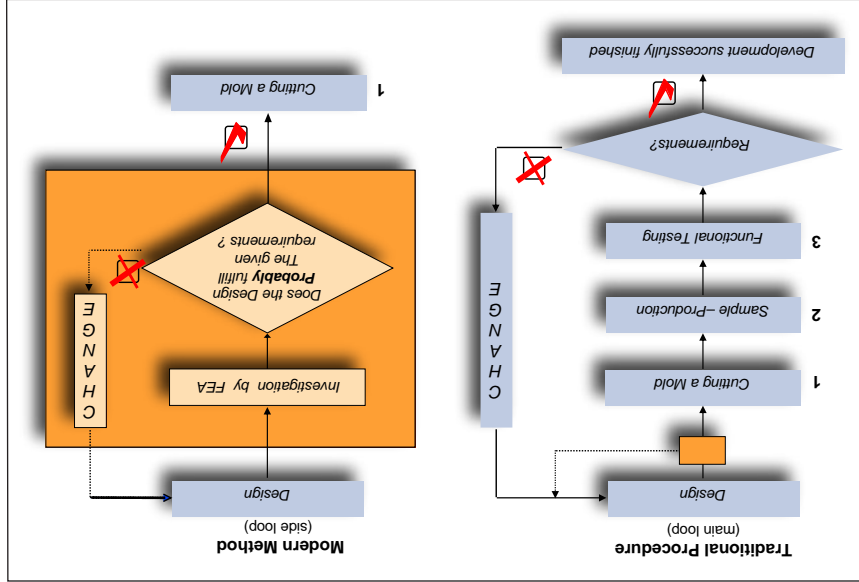

Figure 2-27. Traditional process vs. modern seal development process using FEA

Materials

Contents

Material Classifications	3-1
Thermoplastics	
Elastomers	3-2
TPU – Polyurethanes	
TPCE – Polymyte®	
Engineered Resins	3-3
Nylons	
UltraCOMP™ (PEEK)	
Thermoset Elastomers	
Rubber	3-4
Nitriles (NBR)	
Nitroxile® (XNBR)	
Hydrogenated Nitrile (HNBR)	
Ethylene Propylene (EPR)	
Fluorocarbon (FKM)	
PTFE	3-6
Non-filled PTFE	
Filled PTFE	
Typical Physical Properties	3-8
Hardness	3-8
Modulus of Elasticity	3-8
Ultimate Tensile Strength	3-8
Ultimate Elongation	3-9
Resilience	3-9
Compression Set	3-9
Parker Materials Typical Physical Properties	
Thermoplastics	3-11
Elastomers	3-11
Resins	3-12
Thermoset Elastomers	3-14
PTFE	3-16
Rubber Energizers for PTFE seals	3-18
Back-ups for PTFE seals	3-19
Chemical Compatibility	3-20
Temperature Limits	3-20
Storage and Handling	3-20

Parker Engineered Materials for the Fluid Power Industry

There are two basic considerations in specifying a well-designed sealing system, both of which are equally integral to system performance: seal configuration, discussed in [Section 2](#), and material, discussed herein. When selecting from the wide range of material options that Parker offers, there are a number of considerations to be made:

- **Typical Physical Properties** give a broad picture of a material's performance.
- **Chemical Compatibility** matches the sealing material with the system fluid and operating environment.
- **Thermal Capabilities and Extrusion Resistance** define limits of application parameters.
- **Friction and Wear** help to determine the performance and life of the seal package.
- **Storage, Handling and Installation guidelines** ensure seal integrity for optimal performance.

With in-house material development and compounding for thermoplastic, thermoset and PTFE materials, the ability to maintain control over all variables during the manufacturing process allows Parker to achieve optimal physical properties of its thermoplastic materials. Parker's commitment to offering the highest quality sealing materials is unsurpassed in the industry. To ensure long life and system integrity, it is critical to consider all variables in an application before specifying a material.

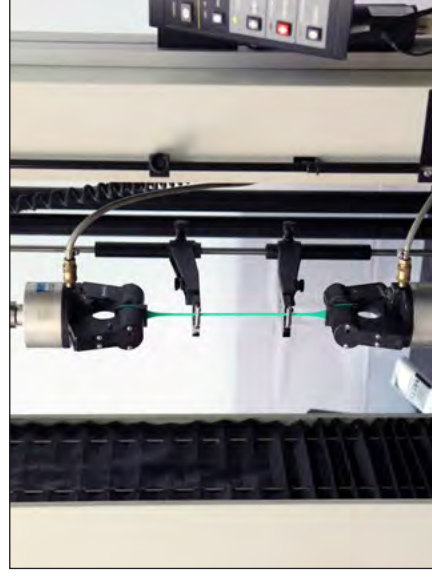

Figure 3-1. Materials Test Lab

Parker EPS Material Classifications

Classes of materials offered by Parker for fluid power profiles include:

- Thermoplastics — Elastomers and Engineered Resins
- Thermoset Elastomers — Rubber (Nitrile, Nitroxile®, EPR, FKM, etc.)
- PTFE — Non-filled and filled TFE materials.

Thermoplastics

All thermoplastics are resins designed to soften and melt when exposed to heat. Utilizing an injection molding process, thermoplastics are melted at high temperature and injected into the mold. It is then cooled causing the plastic to solidify. If high heat is introduced again, the molded part will melt. The molecules of thermoplastics are held together by physical bonds rather than chemical bonding.

Elastomers – Polyurethane (TPU)

Polyurethanes exhibits outstanding mechanical and physical properties in comparison with other elastomers. Specifically, its wear and extrusion resistance make it a popular choice for hydraulic applications. Its temperature range is generally -65°F to +200°F (-54°C to +93°C), with some compounds, such as Resilon® 4300 having higher temperature ratings up to +275°F (+135°C). Polyurethanes are highly resistant to petroleum oils, hydrocarbon fuels, oxygen, ozone and weathering. On the other hand, they will deteriorate quickly when exposed to acids, ketones and chlorinated hydrocarbons. Unless specifically formulated to resist hydrolysis (Resilon® 4301), many types of polyurethanes are sensitive to humidity and hot water. Other acronyms polyurethane may be known by are AU, EU, PU, and TPU or may simply be known as urethanes. For typical physical properties, see [Table 3-1 on page 3-11](#).

P4300A90 – Resilon® 4300 TAN
90 Shore A hardness polyurethane manufactured by Parker specifically for sealing applications. This proprietary compound was developed to offer extended temperature capability, excellent resistance to compression set and high rebound characteristics that are unparalleled in the industry. USP Class VI certified. NSF/ANSI 61 certified. 

P4301A90 – Resilon® 4301 AQUA
90 Shore A hardness polyurethane formulated for water resistance. This Parker proprietary compound can be used for both water and petroleum based fluids. USP Class VI certified.

P4304D60 – Resilon® 4304 BROWN
60 Shore D hardness polyurethane formulated to resist extrusion. This compound offers higher extrusion resistance for seals and anti-extrusion devices.



Figure 3-2. Resilon® 4301 (P4301A90)

P4306A90 – Resilon® 4306 TAN
90 Shore A hardness polyurethane formulated for lower friction and heat resistance. This material features proprietary lubrication for lower friction to help reduce heat build-up and wear.

P4311A90 – Resilon® 4311 RED
90 Shore A hardness polyurethane with high resilience and lower friction. This formulation resists internal heat generated through hysteresis making this compound ideal for shock applications such as bumpers.

P4500A90 – Polyurethane GREEN
90 Shore A hardness polyurethane with good abrasion and extrusion resistance to improve the life of the seal. It also has excellent rebound which enhances response time to shock and side loading.

P4615A90 – Molythane® BLACK
P4615A90 is a 90 Shore A hardness, general purpose polyurethane, offering high abrasion and extrusion resistance and is an industrial standard sealing compound. USP Class VI certified.

P4617D65 – Molythane® BLACK
P4617D65 is a harder, 65 Shore D, version of Molythane ideal for use in anti-extrusion devices.

P4622A90 – Ultrathane® YELLOW
90 Shore A hardness polyurethane formulated with internal lubricants for lower friction to help reduce heat build-up and wear.

P4700A90 – Polyurethane

GREEN

90 Shore A hardness polyurethane formulated to offer enhanced physical properties over Molythane with improved sealing capabilities due to lower compression set and higher rebound.

P5065A88 – Low Temp Polyurethane DARK BLUE

88 Shore A hardness polyether based polyurethane formulated for an improved low temperature range and higher resilience than Molythane. This compound offers a softer feel for easy installation.

Elastomers – Polymyte® (TPCE)

Polymyte is a Parker proprietary polyester elastomer. It has exceptionally high tear strength, abrasion resistance, modulus, and a wide temperature range of -65°F to +275°F (-54°C to +135°C). Polymyte is resistant to petroleum fluids, some phosphate ester and chlorinated fluids, common solvents and water below +180°F. It is not compatible with cresols, phenols, and highly concentrated acids. Due to its higher hardness and modulus, seals made from this material can be difficult to install. Also, care must be taken not to damage the seal lips during assembly into the gland.

Z4651D60 – Polymyte® ORANGE

60 Shore D hardness Polymyte is used for seals in applications requiring extended extrusion resistance and/or fluid compatibility.

Z4652D65 – Polymyte® ORANGE

65 Shore D hardness Polymyte is ideal for back-ups and other anti-extrusion devices.

Engineered Resins

Engineered resins such as Nylons and PEEK, sometimes called hard plastics, are generally categorized as compounds with hardness measured on the Rockwell M or R scale. These compounds exhibit high tensile and compressive strength and are typically used in wear rings for bearing support and in auxiliary devices for extrusion resistance. For typical physical properties, see [Table 3-2 on page 3-12](#).

Engineered Resins – Nylons

W4650 – MolyGard® GRAY

Heat stabilized, internally lubed, 30% glass-reinforced nylon for standard tolerance wear rings.

W4655 – Nylon 6,6 with MoS₂

GRAY

Wear resistant nylon loaded with molybdenum disulfide (MoS₂) for reduced friction. This compound is ideally suited for use in back-up rings. W4655 is susceptible to water absorption.

W4733 – WearGard™

GREEN

Heat stabilized, internally lubricated, 35% glass reinforced nylon for tight-tolerance wear rings. WearGard is a dimensionally stable compound with high compressive strength and is featured in Parker's distinctive green color.

Engineered Resins – UltraCOMP™ (PEEK)

UltraCOMP engineered thermoplastics are semicrystalline materials manufactured for extreme temperatures, chemicals and pressures. Their excellent fatigue resistance and stability in high temperature environments make them the material of choice where other materials fail. With a melt temperature of over +600°F, UltraCOMP can be used at continuous operating temperatures of -65°F up to +500°F. Superior strength and wear resistance properties make it an ideal alternative to metal or metal alloys in applications where weight, metal-to-metal wear or corrosion issues exist. Such capabilities translate into reduced equipment down time and increased productivity. For example, UltraCOMP back-up rings exhibit optimum strength-flexibility for ease of installation and high tensile strength properties for premiere extrusion resistance. UltraCOMP is available in molded geometries and machined geometries.

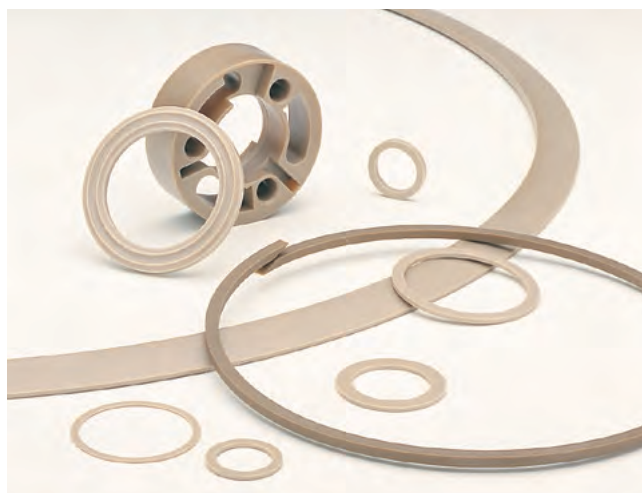

Figure 3-3. UltraCOMP™ HTP (PEEK)

W4685 — UltraCOMP™ HTP (PEEK)**TAN**

An unfilled engineered thermoplastic material specified for use in extreme conditions spanning multiple industries. Its excellent tensile strength facilitates its successful use as back-up rings and anti-extrusion devices. In addition, UltraCOMP HTP's elongation properties (>60% per ASTM D638) allow it to be flexed and twisted without breaking.

W4686 — UltraCOMP™ GF (PEEK)**TAN**

30% glass filled blend provides enhanced compressive strength over UltraCOMP HTP.

W4737 — UltraCOMP™ CF (PEEK)**Black**

30% carbon fiber blend provides enhanced tensile and compressive strength over UltraCOMP GF.

W4738 — UltraCOMP™ CGT (PEEK)**Gray**

10% carbon, 10% graphite, and 10% PTFE blend for enhanced compressive strength and reduced friction.

Thermoset Elastomers — Rubber

Unlike thermoplastic elastomers, thermoset elastomers gain their strength from an irreversible cross linking process that occurs when the compound is subjected to pressure and heat. During this process, or “cure”, special chemical agents within the compound react to the heat and pressure to vulcanize the molecules together. Once cured, thermoset compounds obtain the necessary physical properties needed to function in fluid sealing applications. Reheating thermoset compounds will not cause them to melt as thermoplastics do. For typical physical properties, see [Table 3-3 on page 3-14](#).

Nitrile (NBR)

Nitrile rubber (NBR) is the general term for acrylonitrile butadiene copolymer. Nitrile compounds offer good resistance to abrasion, extrusion, and compression set. The acrylonitrile (ACN) content influences the physical properties of the compound. As the ACN content increases, oil and solvent resistance improve, tensile strength, hardness and abrasion resistance increase, while permeability, low temperature flexibility, and resilience decrease. Parker offers a variety of nitrile compounds, formulated with varying ACN content, to provide the best physical properties for a wide range of applications. Typical temperature ratings are -40°F to +250°F (-40°C to +121°C).



Figure 3-4. Thermoset elastomers

N4008A80 — NBR**Black**

80 Shore A hardness low temperature nitrile. This is a premium, low ACN nitrile for use when low temperature sealability is the primary requirement.

N4115A75 — NBR**Black**

75 Shore A hardness general purpose nitrile with medium ACN content for use where a softer seal is needed.

N4121A90 — NBR**Black**

90 Shore A hardness, high ACN nitrile with an exceptionally high modulus which gives this compound outstanding extrusion resistance. N4121A90 also has good compression set properties.

N4180A80 — NBR**Black**

80 Shore A hardness general purpose nitrile with medium ACN content. N4180A80 has good chemical compatibility, sealability and moderate extrusion resistance. N4180A80 has excellent compression set resistance even at higher temperatures.

N4181A80 — NBR**Black**

80 Shore A hardness, medium ACN nitrile with fiber added for reinforcement. The fibers also help to retain lubrication for reduced friction. N4181A80 is often used in the 8600 wiper seal to resist extrusion.

N4182A75 — NBR**Black**

75 Shore A hardness, general purpose nitrile for use when low temperature sealability is required.

Nitroxile® (Carboxylated Nitrile) (XNBR)

Carboxylated nitriles are formed by exposing nitrile polymer to carboxylic acid groups during polymerization. This forms an improvement over nitrile by producing a more wear resistant seal compound with enhanced modulus and tensile strength. Nitroxile® offers exceptionally low friction characteristics and has excellent resistance to petroleum oils, hydrocarbon fuels and water. The typical temperature range for Nitroxile is -10°F to +250°F (-23°C to +121°C).

N4257A85 — XNBR

BLACK
85 Shore A hardness carboxylated nitrile that has an internal lubricant as an aid to reduce friction. It is ideal for pneumatic applications with excellent compression set properties.

N4263A90 — XNBR

BLACK
90 Shore A hardness carboxylated nitrile that is formulated for increased hardness, modulus and tensile strength to provide extra toughness in applications requiring nitrile seals. This compound has excellent resistance to extrusion, explosive decompression and abrasion.

N4274A85 — XNBR

BLACK
85 Shore A hardness carboxylated nitrile that is formulated with a proprietary internal lubricant for exceptionally low friction operation. This is the premier carboxylated nitrile in the sealing industry.

N4283A75 — XNBR

BLACK
75 Shore A hardness carboxylated nitrile with an internal lubricant as an aid to reduce friction. It is ideal for pneumatic applications with excellent compression set properties.

Hydrogenated Nitrile (HNBR)

Hydrogenated nitrile offers improved chemical compatibility and heat resistance over standard nitrile by using hydrogen in the formulation to saturate the backbone of the nitrile molecule. However, the compound usually becomes less flexible at low temperatures. This can be offset to some degree by adjusting the ACN content as is done with NBR. Typical temperature ratings are -25°F to +320°F (-32°C to +160°C).

N4007A95 — HNBR

BLACK
95 Shore A hardness hydrogenated nitrile featuring excellent resistance to extrusion and explosive decompression to meet Norsok M-710.

N4031A85 (KA183) — HNBR

BLACK
85 Shore A hardness hydrogenated nitrile formulated for low temperatures.

N4032A80 (KB162)² — HNBR

BLACK
80 Shore A hardness hydrogenated nitrile.

N4033A90 (KB163) — HNBR

BLACK
90 Shore A hardness hydrogenated nitrile formulated for improved chemical compatibility.

Ethylene Propylene (EPR)

Ethylene propylene has excellent dimensional stability in water-based fluids and steam; however, it should never be exposed to petroleum lubricants, water / oil emulsions, solvents or other petroleum based fluids (CAUTION! Do not lubricate the seals with petroleum oils or greases during installation). Ethylene propylene rubber is compatible with Skydrol^{®3} and other phosphate ester fluids used in aircraft hydraulic systems. EPR is also the recommended seal material for automotive brake fluids (DOT 3, 4 and 5) as well as many commercial refrigerants. Ethylene propylene rubber is also useful in sealing weak alkalis, acids, and methyl ethyl ketone (MEK). The typical temperature range is -65°F to +300°F (-54°C to +149°C). Maximum temperature in water or steam is +400°F (+240°C).

E4207A90 — EPR

BLACK
90 Shore A hardness general purpose EPR with excellent dimensional stability in water-based fluids and steam. With its additional hardness it is able to be used at higher pressures than the 80 Durometer compounds. It has excellent compression set properties as well as excellent compatibility with such fluids as DOT 3 brake fluid.

E4259A80 — EPR

BLACK
80 Shore A hardness general purpose EPR with excellent dimensional stability in water-based fluids and steam. This compound has excellent chemical compatibility and compression set resistance.

E4270A90 — EPR

BLACK
90 Shore A hardness EPR formulated for steam/ geothermal environments with an upper temperature range of +600°F (+315°C). Excellent compression set resistance.

² Compound numbers in parenthesis cross-reference to Parker Engineered Materials Group "ORD" material numbers.

³ Skydrol[®] is a registered trademark of Solutia Inc.

Fluorocarbon Elastomers (FKM)

Fluorocarbon elastomers are highly specialized polymers that show the best resistance of all rubbers to chemical attack, heat and solvents. FKM is of critical importance in solving problems in aerospace, automotive, chemical and petroleum industries. FKM is suitable for use in most hydraulic fluids except Skydrol® types and ester-ether fluids. Standard temperatures range from -20°F to +400°F (-29°C to +204°C).

V1238A95 – FKM **BLACK**

95 Shore A hardness fluorocarbon resistant to explosive decompression and extrusion. Improved low temperature performance of -20°F to +400°F (-29°C to +204°C).

V1289A75 – FKM **BLACK**

75 Shore A hardness fluorocarbon formulated for improved low temperature performance of -40°F to +400°F (-40°C to +204°C).

V4205A75 – FKM **BLACK**

75 Shore A hardness general purpose fluorocarbon.

V4208A90 – FKM **BLACK**

90 Shore A hardness general purpose fluorocarbon.

V4266A95 – FKM **BLACK**

95 Shore A hardness extended wear and extrusion resistant fluorocarbon.

V4281A85 – FKM **BLACK**

85 Shore A hardness fluorocarbon formulated for improved low temperature performance of -30°F to +400°F (-34°C to +204°C).

PTFE

PTFE (Polytetrafluoroethylene) offers the following characteristics over thermoplastic and thermoset compounds, making it a unique problem solving solution for sealing applications:

- Low coefficient of friction
The low coefficient of friction (.06) of PTFE material results from low interfacial forces between its surface and other materials that come in contact. This behavior of PTFE material eliminates any possibility of stick-slip effects in dynamic sealing applications.
- Wide temperature range
PTFE's high melting point and morphological characteristics allow components made from the resin to be used continuously at service temperatures to +600°F (+315°C). For sealing cryogenic fluids below -450°F (-268°C), special designs using PTFE and other fluoropolymers are available.
- Chemically inert
- Dry running capability
- Resist temperature cycling
- High surface speeds
- Low water absorption
- Low dielectric constant and dissipation factor

Enhancing Performance of PTFE with Fillers

In fluid power applications, it can be beneficial to add fillers to PTFE compounds in order to enhance their physical characteristics. Specific fillers can be incorporated to provide improved compression strength, wear, creep and extrusion resistance.

Non-Filled PTFE

0100 – Virgin PTFE **WHITE**

Virgin PTFE has no fillers and is considered FDA and potable water safe.

Filled PTFE

0102 – Modified Virgin PTFE **TURQUOISE**

Virgin PTFE modified with custom pigmentation features similar basic properties as virgin, but offers increased wear and creep resistance and lower gas permeability.



Figure 3-5. PTFE

3

0120 – Mineral Filled **WHITE**

Mineral is ideal for improved higher temperatures and offers low abrasion to soft surfaces. PTFE with this filler can easily be qualified to FDA and other food-grade specifications.

0203 – Fiberglass Filled **GOLD**

Glass fiber is the most common filler with a positive impact on creep performance of PTFE. Glass fiber adds wear resistance and offers good compression strength.

0204 / 0205 – MoS₂ and Fiberglass Filled **GRAY**

Molybdenum disulfide (MoS₂) increases the hardness of the seal surface while decreasing friction. It is normally used in small proportions and combined with other fillers such as glass. MoS₂ is inert towards most chemicals. 0205 blended for improved compressive strength.

0301 – Graphite Filled **BLACK**

Graphite filled PTFE has an extremely low coefficient of friction due to the low friction characteristics of graphite. Graphite is chemically inert. Graphite imparts excellent wear properties and high PV values to PTFE.

0307 – Carbon-Graphite Filled **BLACK**

Carbon reduces creep, increases hardness and elevates the thermal conductivity of PTFE. Carbon-graphite compounds have good wear resistance and perform well in non-lubricated applications.

0401 – Bronze Filled **BRONZE**

Bronze is a self lubricated, long-wearing material that offers superior frictional characteristics and high temperature capabilities.

0502 – Carbon Fiber Filled **BROWN**

Carbon fiber lowers creep, increases flex and compressive modulus and raises hardness. Coefficient of thermal expansion is lowered and thermal conductivity is higher for compounds of carbon fiber filled PTFE. This is ideal for automotive applications in shock absorbers and water pumps.

0601 – Aromatic Polyester Filled **TAN**

Aromatic polyester is excellent for high temperatures and has excellent wear resistance against soft, dynamic surfaces. This filler is not recommended for sealing applications involving steam.

Composite Resins

0810 – Standard Polyester Based With PTFE **PINK**

Polyester-based fabric-reinforced resin formulated to handle severe side loads and swell from moisture. Internally lubricated for dry running service. Typical temperature rating is -40°F to +200°F (-40°C to +93°C).

0811 – Graphite Filled Polyester Based **GRAY**

Polyester-based fabric-reinforced resin filled with graphite to handle severe side loads and swell from moisture. Low friction, non-lubricated service. Typical temperature rating is -40°F to +200°F (-40°C to +93°C).

0812 – MoS₂ Filled Polyester Based **GRAY**

High temperature polyester-based fabric-reinforced resin filled with molybdenum disulfide. Low friction, non-lubricated service. Typical temperature rating is -40°F to +400°F (-40°C to +204°C).

0813 – PTFE Filled Polyester Based **YELLOW**

High temperature vinyl ester-based fabric-reinforced resin filled with PTFE. Internally lubricated for dry running service. Typical temperature rating is -40°F to +400°F (-40°C to +204°C).

Typical Physical Property Information

There are six significant typical physical properties that affect seal performance. It is important to understand how the physical properties of a compound relate to each sealing application and to know that the fluid being sealed may change these original characteristics. The six critical properties identified below each show detail concerning their impact on sealing as well as measurement techniques.

1 – Hardness

Hardness, also referred to as durometer, is a property frequently associated with extrusion resistance when exposed to pressure (see [Table 2-4 on page 2-5](#)). It is not a good indication of extrusion resistance when comparing different material classifications. For example, a polyurethane and a nitrile compound with the same hardness will not share the same extrusion resistance. Hardness also relates to low pressure sealability, since the ability of a seal to conform to a mating surface depends, to a high degree, on the hardness of the material. The harder a material, the less it will conform to a sealing surface at low pressure. As hardness increases, modulus and compressive strengths typically increase as well. This means that harder seals are typically more difficult to install and often have greater friction.

Hardness is measured by how easily a specified surface is deformed by an indenter. “Shore A” and “Shore D” are the two most common scales for seal materials. Both scales use a rounded indenter to impact the surface being measured. Shore A is typically used to measure softer materials, while harder materials are measured on the Shore D scale. Although the Shore A scale has a max value of 100, it is recommended to switch to the Shore D scale past 95 Shore A. These two scales overlap one another as shown in Figure 3-6.

Standardized test methods for this physical property are ASTM 2240 and DIN 53505, which corresponds to ISO 48. This test procedure has a repeatability of ± 5 points, because its accuracy is dependent on the flatness of the specimen and the skill of the technician. For this reason, measuring material hardness on a seal itself, with its irregular surface, is discouraged and can only be used with caution as a relative value.

A second method of measuring hardness that is seldom used and is only presented here for

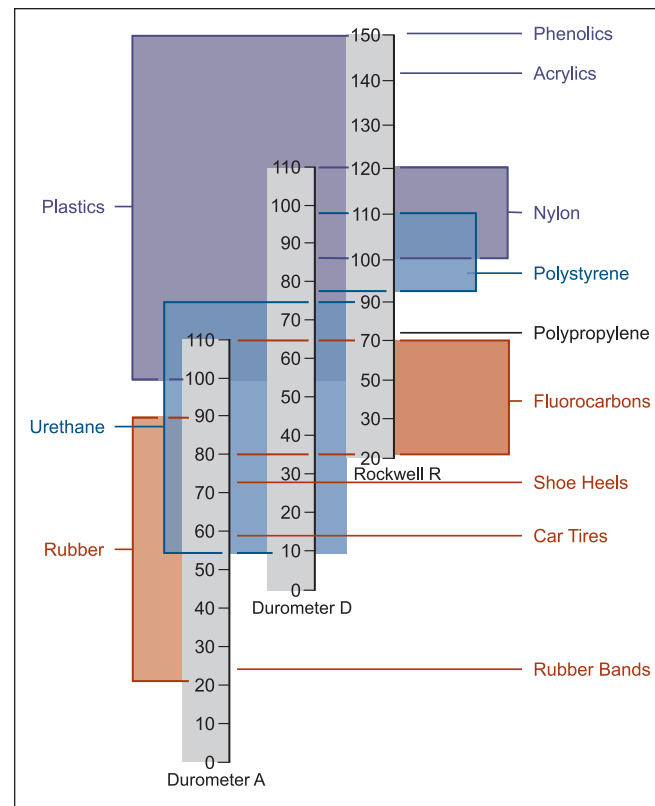

Figure 3-6. Hardness Scale Comparison Between Shore A, Shore D, and Rockwell R

informational purposes is the International Rubber Hardness Degree (IRHD), as described in ASTM 1414/1415, Din 53519, and ISO 1400/1818. The IRHD and Shore methods do not provide comparable values and should not be used to relate one material to another.

2 – Modulus

Modulus is truly what gives a seal material its extrusion resistance. It is a measure of the force required to stretch an elastomer a certain percentage of its original length. Modulus of a material can more simply be thought of as its stiffness and is also an indication of the ease of installation. Higher modulus materials resist stretching and compression, increasing installation difficulty. (ASTM method D412)

3 – Ultimate Tensile Strength

Ultimate tensile strength is closely related to wear resistance, toughness and therefore service life of the seal. This property is the amount of force required to reach ultimate elongation, physically breaking the material. Polyurethane and filled PTFE compounds generally have very high tensile strength, providing the associated excellent tear and abrasion resistance. Most rubber compounds have much lower tensile strength values, often resulting in one fifth the wear

Modulus of Elasticity measures the force per area to stretch a sample to a certain percentage of its original length.



Example: To stretch a 1 inch sample to 2 inches, is a 100% stretch.

Figure 3-7. Modulus of Elasticity

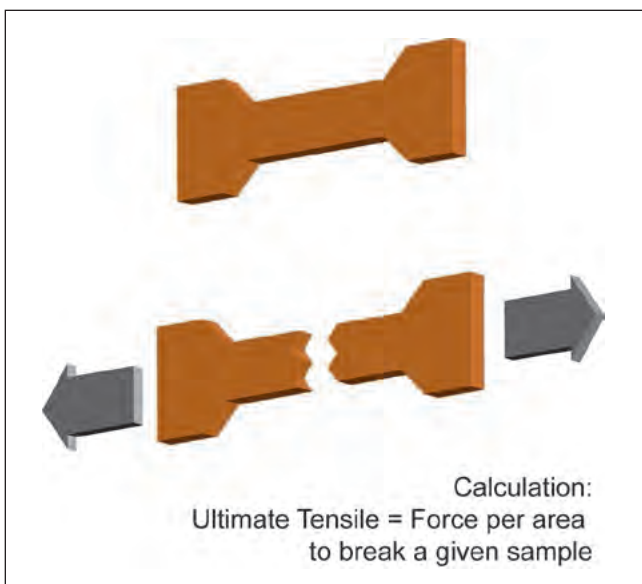

Figure 3-8. Tensile Strength

life of higher tensile materials. (ASTM method D412 and DIN 53504) *It should be noted that values obtained from the DIN standard are typically higher than those from the ASTM standard as there is a difference in the test specimen and the pull rate.*

4 – Ultimate Elongation

Ultimate elongation is most closely associated with installation, but can also be a good indicator of chemical compatibility. This property is the distance a material will stretch before breaking, expressed as a percentage of its original length. It can be important in small diameter seals because it can limit the amount of stretch available for installation.

Elongation is also a good indicator of chemical compatibility. If changes are observed after a material sample is soaked in a fluid, it is possible that the seal is being adversely affected. In this situation, the fluid will typically attack and break the polymeric chain, reducing the ultimate elongation. (ASTM method D412)

5 – Resilience

Resilience, also known as rebound, strongly correlates to how quickly a seal will respond to changing conditions in a dynamic environment. This property measures the ability of a material to return to its original shape after being deformed, as well as the speed at which it can achieve this.

Examples of conditions that require seals to exhibit excellent resilience are out-of-round cylinders and rapid side loading situations that cause the rod to move sideways quickly. Applications with high vibration or high stroke speed can also benefit from high resiliency seals. (ASTM method D2632, DIN 53512)

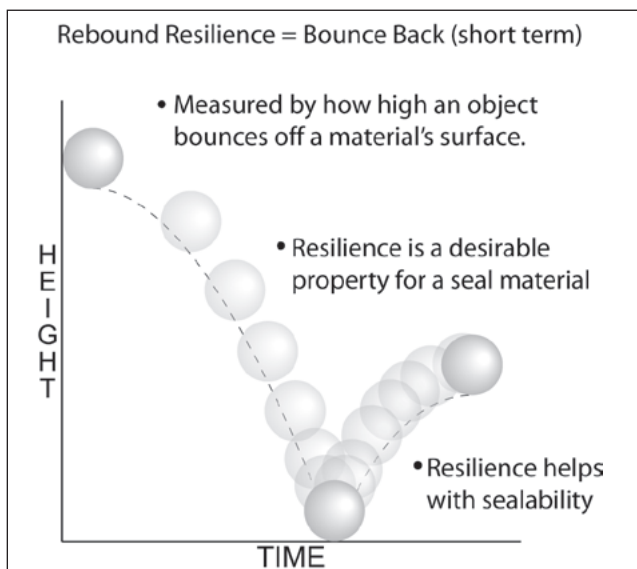

Figure 3-9. Rebound Resilience

6 – Compression Set

Compression set is the inability of a seal to return to its original shape after being compressed. It is associated with a sealing material's "long-term memory" and is considered to be one of the most critical properties of the seal. For a seal to maintain radial pressure and establish a continuous sealing line, it must resist stress relaxation during the time and at the temperature to which it is exposed. As the seal begins to take a compression set, it loses

its inherent ability to seal and may require other influences to maintain a positive sealing force. Examples of such factors would be system pressure or an expander working to energize the sealing lips. The lowest possible compression set value is always advantageous because it represents the least amount of lost sealing force over time.

As defined by ASTM, compression set is the percent of deflection by which the seal fails to recover after a specific deflection, time and temperature (see Figure 3-10). When comparing compression set values between two materials, it is important to note both the time and temperature of the tests being compared. Even though a typical compression set value is based on a 70 hour period, many times a 22 hour period may be used for time and convenience sake. A 22 hour compression set value will always be dramatically better than that of a 70 hour test under the same temperature condition. It is also important to know that each elastomer family is generally tested at a different temperature or series of temperatures. Be sure that the temperatures of the test data closely approximate the temperature the seal will be used in. (ASTM method D395, DIN 53517)

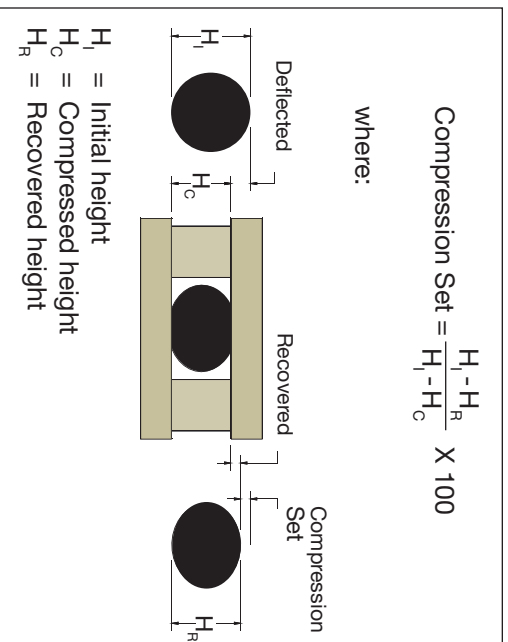

Figure 3-10. Compression set calculation

Parker Materials Typical Physical Properties

Typical physical properties for Parker fluid power product materials are shown in the corresponding tables:

Material Classification	Table (page)
Thermoplastics	
Elastomers	
TPU	Table 3-1, (pg 3-11)
Polyurethanes	
TPCE Polymyte®	
Engineered Resins	
Nylons	Table 3-2, (pgs. 3-12, 3-13)
UltraCOMP™ (PEEK)	
Composite Resins	
Thermoset Elastomers	
Rubber Nitriles Nitroxile® Ethylene Propylene Fluorocarbon	Table 3-3 (pgs. 3-14, 3-15)
PTFE for Fluid Power Seals	
Non-filled PTFE Filled PTFE	Table 3-4 (pgs. 3-16, 3-17)
Rubber energizer materials for PTFE fluid power seals	Table 3-5 (pg 3-18)
Back-up ring materials for PTFE fluid power seals	Table 3-6 (pg 3-19)

Table 3-1. Typical Physical Properties: Thermoplastics — Elastomers

Parker Material Code	Material Trade Name (Color)	Typical Applications and Description	Service Temperature Range °F (°C)	Tensile Strength at Break psi (MPa)	Ultimate Elongation	Shore Hardness		100% Modulus psi (MPa)	Compression Set		Abrasion Rating Best = 10	
						A	D		Set	at °F (°C)		
Thermoplastic Elastomers — TPU, Polyurethanes												
P4300A90	Polyurethane Resilon® 4300 (Tan)	Proprietary compound offering extended temperature range, high rebound. USP Class VI, NSF/ANSI 61 certified.	-65 to +275 (-54 to +135)	8021 (55.3)	638%	90	—	1674 (11.5)	30.9%	+212 (+100)	61%	10
P4301A90 (oil) (water)	Polyurethane Resilon® 4301 (Aqua)	For petroleum based fluids. For water based fluids. USP Class VI certified.	-35 to +275 (-37 to +135)	7188 (49.6)	548%	92	—	1958 (13.5)	22.3%	+158 (+70)	41%	8.1
			-35 to +225 (-37 to +107)									
P4304D60	Polyurethane Resilon® 4304 (Brown)	Offers higher extrusion resistance for seals and anti-extrusion devices.	-65 to +275 (-54 to +135)	6896 (47.5)	571%	—	56	2949 (20.3)	40.9%	+158 (+70)	56%	9.8
P4306A90	Polyurethane Resilon® 4306 (Tan)	Formulated for low friction.	-65 to +275 (-54 to +135)	6480 (44.7)	626%	91	—	1490 (10.3)	30.3%	+158 (+70)	62%	9.0
P4311A90	Polyurethane Resilon® 4311 (Red)	Formulation resists internal heat generated through hysteresis, ideal for shock applications.	-65 to +275 (-54 to +135)	7475 (51.5)	628%	92	—	1698 (11.7)	35.9%	+212 (+100)	63%	8.2
P4500A90	Polyurethane (Green)	Offers good abrasion and extrusion resistance with excellent rebound.	-65 to +200 (-54 to +93)	6585 (45.4)	555%	93	—	1831 (12.6)	32.9%	+158 (+70)	42%	7.6
P4615A90	Polyurethane Molythane® (Black)	General purpose industrial polyurethane offering high abrasion resistance. USP Class VI certified.	-65 to +200 (-54 to +93)	7368 (50.8)	557%	94	—	1828 (12.6)	29.2%	+158 (+70)	36.4%	9.4
P4617D65	Polyurethane Molythane® (Black)	General purpose industrial polyurethane offering high extrusion resistance.	-65 to +225 (-54 to +107)	5504 (37.9)	475%	—	66	3485 (24.0)	—	—	—	6.7
P4622A90	Polyurethane Ultrathane® (Yellow)	Formulated with internal lubricants for lower friction to help reduce heat build up.	-65 to +225 (-54 to +107)	6759 (46.6)	507%	95	—	1874 (12.9)	31.8%	+158 (+70)	32%	7.6
P4700A90	Polyurethane (Green)	Enhanced properties over 4615 to improve sealing capabilities from lower compression set.	-65 to +200 (-54 to +93)	5783 (39.9)	568%	92	—	1786 (12.3)	22.8%	+158 (+70)	41%	6.3
P5065A88	Polyurethane (Dark Blue)	Formulated for an improved low temperature range and higher resilience than 4615.	-70 to +200 (-57 to +93)	5033 (34.7)	660%	86	—	1073 (7.4)	27.2%	+158 (+70)	50%	5.5
Thermoplastic Elastomers — TPCE, Polymyte®												
Z4651D60	Polymyte® (Orange)	Used in applications requiring extended extrusion resistance and fluid compatibility.	-65 to +275 (-54 to +135)	5807 (40.0)	715%	—	56	2466 (17.0)	44.2%	+158 (+70)	—	6.4
Z4652D65	Polymyte® (Orange)	Primarily used for back-up rings and other anti-extrusion devices.	-65 to +275 (-54 to +135)	6171 (42.5)	698%	—	60	2607 (18.0)	45.5%	+158 (+70)	—	6.9

Table 3-2. Typical Physical Properties: Thermoplastics — Engineered Resins

Parker Material Code	Material	Color	Typical Applications and Description	Service Temperature Range °F (°C)	Tensile Strength at Break psi (MPa)	Flexural Strength psi (MPa)
Nylons						
W4650	MolyGard®	Gray	Heat stabilized, internally lubed 30% glass-reinforced nylon for standard tolerance wear rings.	-65 to +275 (-54 to +135)	17500 (121)	22600 (156)
W4655	Nylon 6,6	Gray	Wear resistant nylon 6,6 with molybdenum disulfide for lower friction, suited for back-up rings.	-65 to +275 (-54 to +135)	13000 (89.6)	16000 (110)
W4733	WearGard™	Green	High compressive strength, 35% glass-reinforced nylon for tight tolerance wear rings.	-65 to +275 (-54 to +135)	18300 (126)	25500 (176)
UltraCOMP™ (PEEK)						
W4685	UltraCOMP™ HTP	Tan	A homogenous engineered thermoplastic used for extreme conditions in many markets.	-65 to +500 (-54 to +260)	14000 (96.5)	23600 (163)
W4686	UltraCOMP™ GF	Tan	30% glass filled engineered thermoplastic with enhanced compressive strength.	-65 to +500 (-54 to +260)	22600 (156)	30700 (212)
W4737	UltraCOMP™ CF	Black	30% carbon fiber blend, provides enhanced tensile and compressive strength.	-65 to +500 (-54 to +260)	32400 (224)	43200 (298)
W4738	UltraCOMP™ CGT	Gray	Thermoplastic material blended with carbon, graphite and PTFE for reduced friction.	-65 to +500 (-54 to +260)	20400 (141)	33400 (230)
Composite Resins						
0810	Standard Polyester Based With PTFE	Pink	Polyester-based fabric-reinforced resin to handle severe sideloads and swell from moisture. Internally lubricated for dry running service.	-40 to +200 (-40 to +93)	11000 (75.8)	—
0811	Graphite Filled Polyester Based	Gray	Polyester-based fabric-reinforced resin filled with graphite to handle severe sideloads and swell from moisture. Low friction, non-lubricated service.	-40 to +200 (-40 to +93)	11000 (75.8)	—
0812	MoS ₂ Filled Polyester Based	Gray	High Temperature Polyester-based fabric-reinforced resin filled with Molybdenum Disulfide. Low friction, non-lubricated service	-40 to +400 (-40 to +204)	11000 (75.8)	—
0813	PTFE Filled Polyester Based	Yellow/Tan	High Temperature vinyl ester-based fabric-reinforced resin filled with PTFE. Internally lubricated for dry running.	-40 to +400 (-40 to +204)	11000 (75.8)	—

06/01/2014

Table 3-2. Typical Physical Properties: Thermoplastics — Engineered Resins (cont'd)

Parker Material Code	Rockwell Hardness		Notched IZOD Impact Strength FT-Lbs/In.	Tensile Modulus Kpsi (MPa)	Shear Strength psi (MPa)	Flexural Modulus Kpsi (MPa)	Compressive Strength psi (MPa)	Permissible Compressive Load psi (MPa)	Water Absorption (24 Hour) %
	M	R							
Nylons									
W4650	77	114	1.37	952 (6560)	9390 (64.7)	860 (5930)	21000 (145)	21700 (150)	0.50 to 0.70
W4655	—	119	1.69	536 (3700)	9500 (65.5)	406 (2800)	12000 (82.7)	—	0.50 to 1.40
W4733	87	117	1.15	899 (6200)	9820 (67.7)	1,100 (7580)	21500 (148)	21700 (150)	0.50 to 0.70
UltraCOMP™ (PEEK)									
W4685	—	126	2	507 (3500)	7687 (53.0)	579 (3990)	17100 (118)	—	0.50
W4686	—	124	2	1653 (11400)	14068 (97.0)	1334 (9200)	31100 (214)	—	0.11
W4737	—	124	2	3234 (22300)	12328 (85.0)	2697 (18600)	34800 (240)	—	0.06
W4738	—	100	2	1464 (10100)	—	1189 (8200)	21700 (150)	—	0.06
Composite Resins									
0810	100	—	—	500 (3450)	—	—	50000 (345)	—	0.10
0811	100	—	—	500 (3450)	—	—	50000 (345)	—	0.10
0812	100	—	—	500 (3450)	—	—	50000 (345)	—	0.10
0813	100	—	—	500 (3450)	—	—	50000 (345)	—	0.10

Table 3-3. Typical Physical Properties – Thermoset Elastomers

Parker Material Code	Material	Color	Typical Applications and Description	Service Temperature Range °F (°C)	Tensile Strength at Break psi (MPa)	Ultimate Elongation	Shore A Hardness	100% Modulus psi (MPa)	Compression Set		Abrasion Rating (1) Worst to (10) Best
									Set	at °F (°C)	
Nitrile (NBR)											
N4008A80	Nitrile	Black	Premium, low ACN nitrile for use when low temperature sealability is required.	-70 to +275 (-57 to +135)	2111 (14.6)	157%	75	1250 (8.6)	18.5%	+212 (+100)	1.8
N4115A75	Nitrile	Black	General purpose nitrile with medium ACN content for use where a softer seal is required.	-40 to +225 (-40 to +107)	2430 (16.8)	282%	75	946 (6.5)	23.6%	+212 (+100)	1.9
N4121A90	Nitrile	Black	High modulus for outstanding extrusion resistance plus good compression set.	-40 to +250 (-40 to +121)	2306 (15.9)	263%	91	1315 (9.1)	24.0%	+212 (+100)	2.2
N4180A80	Nitrile	Black	General purpose nitrile with good chemical compatibility, seal ability and compression set.	-40 to +250 (-40 to +121)	2114 (14.6)	287%	80	1174 (8.1)	14.4%	+212 (+100)	1.9
N4181A80	Flocked Nitrile	Black	Fiber added reinforcement helps retain lubrication for reduced friction. Used in 8600 wipers.	-40 to +250 (-40 to +121)	2542 (17.5)	310%	78	850 (5.9)	39.6%	+212 (+100)	2.2
N4182A75	Nitrile	Black	General purpose nitrile for use when low temperature sealability is required.	-65 to +225 (-54 to +135)	2164 (14.9)	199%	76	1088 (7.5)	16.9%	+212 (+100)	1.8
Carboxylated Nitroxile® (XNBR)											
N4257A85	Nitroxile®	Black	XNBR with internal lubricant to reduce friction. Ideal for pneumatic applications.	0 to +250 (-18 to +121)	3147 (21.7)	227%	84	1554 (10.7)	20.0%	+212 (+100)	2.7
N4263A90	Nitroxile®	Black	Extra tough XNBR with increased hardness, modulus and tensile strength.	-20 to +275 (-29 to +135)	3401 (23.4)	117%	91	3208 (22.1)	28.3%	+212 (+100)	3
N4274A85	Nitroxile®	Black	Premier XNBR in the industry formulated with proprietary internal lubricant.	-10 to +250 (-23 to +121)	3232 (22.3)	221%	84	1654 (11.4)	21.8%	+212 (+100)	2.9
N4283A75	Nitroxile®	Black	XNBR with internal lubricant to reduce friction. Ideal for pneumatic applications.	0 to +250 (-18 to +121)	2344 (16.2)	197%	71	805 (5.6)	23.3%	+212 (+100)	2.7
Hydrogenated Nitrile (HNBR)											
N4007A95	HNBR	Black	Excellent extrusion resistance and explosive decompression to meet Norsok M-710	-20 to +320 (-29 to +160)	4639 (32.0)	185%	93	2413 (16.6)	14.9%	+212 (+100)	5.0
N4031A85 (KA183)	HNBR	Black	Equivalent to Parker Hannifin O-ring Division compound KA183A85, offers low temperature improvement.	-40 to +320 (-40 to +160)	2551 (17.6)	139%	88	1947 (13.4)	18.0%	+212 (+100)	1.4
N4032A80 (KB162)	HNBR	Black	Equivalent to Parker Hannifin O-ring Division compound KB162A80 offering improved chemical compatibility.	-25 to +320 (-32 to +160)	3931 (27.1)	170%	86	2562 (17.7)	6.0%	+302 (+150)	3.3
N4033A90 (KB163)	HNBR	Black	Equivalent to Parker Hannifin O-ring Division compound KB163A90 offering improved chemical compatibility	-25 to +320 (-32 to +160)	3751 (25.9)	129%	89	3204 (22.1)	14.4%	+302 (+150)	3.2

06/01/2014

Table 3-3. Typical Physical Properties – Thermoset Elastomers (cont'd)

Parker Material Code	Material	Color	Typical Applications and Description	Service Temperature Range °F (°C)	Tensile Strength at Break psi (MPa)	Ultimate Elongation	Shore A Hardness	100% Modulus psi (MPa)	Compression Set		Abrasion Rating (1) Worst to (10) Best	
									Set	at °F (°C)		
Ethylene Propylene (EPR)												
E4207A90	Ethylene Propylene	Black	General purpose 90A EPR, has excellent dimensional stability in water-based fluids and steam.	-65 to +300 (-54 to +149)	2101 (14.5)	130%	86	1452 (10.0)	13.0%	+257 (+125)	2.0	
E4259A80	Ethylene Propylene	Black	General purpose 80A EPR, has excellent dimensional stability in water-based fluids and steam.	-65 to +300 (-54 to +149)	2346 (16.2)	177%	80	998 (6.9)	12.8%	+257 (+125)	1.8	
E4270A90	Ethylene Propylene	Black	Formulated for geothermal environments and steam up to +600°F.	-65 to +400 (-54 to +204)	2904 (20.0)	131%	87	1998 (13.8)	27.1%	+302 (+150)	3.0	
Fluorocarbon Elastomers (FKM)												
V1238A95	Fluoro-elastomer	Black	Resistant to explosive decompression and extrusion. Shows no visual physical damage after prolonged exposure to 100% CO ₂ concentrations.	-20 to +400 (-29 to +204)	3030 (20.9)	95%	93	3079 (21.2)	12.5%	+302 (+150)	1.0	
V1289A75	Fluoro-elastomer	Black	Fluorocarbon material formulated for improved low temperature applications.	-40 to +400 (-40 to +204)	1791 (12.3)	124%	75	1307 (9.0)	18.7%	+302 (+150)	1.0	
V4205A75	Fluoro-elastomer	Black	70 Shore A general purpose fluorocarbon resistant to chemical attack and heat.	-20 to +400 (-29 to +204)	2169 (15.0)	177%	75	803 (5.5)	6.7%	+302 (+150)	1.8	
V4208A90	Fluoro-elastomer	Black	90 Shore A general purpose fluorocarbon resistant to chemical attack and heat.	-5 to +400 (-21 to +204)	2284 (15.7)	142%	87	1549 (10.7)	11.2%	+302 (+150)	1.6	
V4266A95	Fluoro-elastomer	Black	Features extended wear and extrusion resistance over general purpose fluorocarbons.	-5 to +400 (-21 to +204)	2408 (16.6)	93%	92	2462 (17.0)	15.3%	+302 (+150)	2.2	
V4281A85	Fluoro-elastomer	Black	85 Shore A general purpose fluorocarbon resistant to chemical attack and heat for low temperature sealing.	-30 to +400 (-34 to +204)	2500 (17.2)	128%	86	2005 (13.8)	13.2%	+302 (+150)	1.6	



Table 3-4. Typical Physical Properties — PTFE

Parker Material Code	Material	Color	Typical Applications and Description	Service Temperature Range °F (°C)	Tensile Strength in psi at Break (bar)	Elongation in %	Hardness Shore D
Non-Filled PTFE							
0100	Virgin PTFE	White	Excellent for cryogenic applications. Good for gases.	-425 to +450 (-254 to +233)	4575 (316)	400	60
Filled PTFE							
0102	Modified PTFE	Turquoise	Lower creep, reduced permeability and good wear resistance.	-320 to +450 (-195 to +282)	4600 (317)	390	60
0120	Mineral Filled PTFE	White	Excellent low abrasion to soft surfaces and improved upper temperature performances. FDA materials.	-250 to +550 (-157 to +288)	4070 (281)	270	65
0203	Fiberglass Filled PTFE	Gold	Excellent compressive strength and good wear resistance.	-200 to +575 (-129 to +302)	3480 (240)	190	67
0204	Fiberglass & Moly Filled PTFE	Gray	Excellent for extreme conditions such as high pressure, temperature and longer wear life on hardened dynamic surfaces.	-200 to +575 (-129 to +302)	3100 (214)	245	62
0205	Fiberglass & Moly Filled PTFE	Gray	Improved compressive strength and wear in rotary applications	-200 to +575 (-129 to +302)	3480 (240)	190	67
0301	Graphite Filled PTFE	Black	Excellent for corrosive service. Low abrasion to soft shafts. Good in unlubricated service.	-250 to +550 (-157 to +288)	3200 (221)	260	60
0307	Carbon-Graphite Filled PTFE	Black	Excellent wear resistance and reduces creep.	-250 to +575 (-157 to +302)	2250 (155)	100	64
0401	Bronze Filled PTFE	Bronze	Excellent extrusion resistance and high compressive loads.	-200 to +575 (-129 to +302)	3200 (221)	250	63
0502	Carbon Fiber Filled PTFE	Brown	Good for strong alkali and hydrofluoric acid. Good in water service.	-200 to +550 (-129 to +288)	3200 (221)	150	60
0601	Aromatic Polyester Filled PTFE	Tan	Excellent high temperature capabilities and excellent wear resistance.	-250 to +550 (-157 to +285)	2500 (172)	200	61

06/01/2014

Table 3-4. Typical Physical Properties – PTFE (cont'd)

Parker Material Code	Coefficient of Friction	Thermal Conductivity (in W/mK)	Coefficient of Thermal Expansion (in/ in/°F x 10 ⁻⁵ at 203°F)	Permanent Deformation Under Load (70°F 2000 psi in %)	Chemical Compatibility Rating	Wear Resistance Rating	High Pressure Extrusion Resistance Rating	FDA/NSF Compliant
Non-Filled PTFE								
0100	0.05 - 0.10	0.30	6.1	7.0	5	1	1	Y
Filled PTFE								
0102	0.05 - 0.10	0.29	6.1	6.9	5	2	2	Y
0120	0.08 - 0.12	0.23	5.6	4.2	5	3	4	Y
0203	0.08 - 0.12	0.27	5.6	6.0	5	5	5	N
0204	0.08 - 0.12	0.28	6.1	6.0	5	4	4	N
0205	0.08 - 0.12	0.27	5.6	6.0	5	5	5	N
0301	0.07 - 0.09	0.39	6.1	3.5	5	4	3	N
0307	0.08 - 0.11	0.35	4.4	2.5	5	4	4	N
0401	0.18 - 0.22	0.45	5.6	4.4	4	4	4	N
0502	0.09 - 0.12	0.31	7.2	1.8	4	5	5	N
0601	0.09 - 0.13	0.32	5.0	5.5	4	4	4	N

Note: We emphasize that this tabulation should be used as a guide only.

The above data is based primarily on laboratory and service tests, but does not take into account all variables that can be encountered in actual use. Therefore, it is always advisable to test the material under actual service conditions before specifying. If this is not practical, tests should be devised that simulate service conditions as closely as possible.

Parker also offers unique material blends and recipes along with a wide variety of other PTFE filler combinations and colors to enhance seal performance in the most extreme application needs. For guidance on material selection for extreme applications, please contact Application Engineering at 801-972-3000.

The following table lists material codes that apply to the rubber energizer used with PTFE fluid power seals. List the corresponding material code in the appropriate location in the part number. Parker has a full range of rubber compounds to suit various temperature, pressure and chemical compatibility requirements. If your application requires an alternate rubber compound, not listed, please consult a Parker application engineer.

Table 3-5. Typical Application Ranges and Recommendations — Rubber Energizers for PTFE Fluid Power Seals

Material Code	Material Description	Shore A Hardness	Temperature Range	Recommended Use	Not Recommend For Use
A	Nitrile (NBR)	70	-30°F to +250°F (-34°C to +121°C)	<ul style="list-style-type: none"> Petroleum oils and fluids Diesel fuel and fuel oils Cold water Silicone oil and grease Mineral oil and grease Vegetable oil HFA, HFB and HFC fluids 	<ul style="list-style-type: none"> Aromatic hydrocarbons Chlorinated hydrocarbons Polar solvents (MEK, ketone, acetone) Phosphate ester fluids Strong acids Automotive brake fluid
B	Low Temperature Nitrile (NBR)	75	-65°F to +225°F (-55°C to +107°C)		
C	Clean Grade Nitrile (NBR)	70	-30°F to +250°F (-34°C to +121°C)		
D	Hydrogenated Nitrile (HNBR)	70	-23°F to +300°F (-32°C to +149°C)		
F	Fluorocarbon (FKM)	70	-15°F to +400°F (-26°C to +205°C)	<ul style="list-style-type: none"> Petroleum oils and fluids Cold water Silicone greases and oils Aliphatic hydrocarbons Aromatic hydrocarbons Fuels Fuels with methanol content 	<ul style="list-style-type: none"> Glycol based brake fluids Ammonia gas, amines, alkalis Superheated steam Low molecular organic acids
H	Silicone HT (VMQ)	70	-65°F to +450°F (-55°C to +232°C)	<ul style="list-style-type: none"> Engine and transmission oil Animal and vegetable oil and grease Brake fluid Fire-resistant hydraulic fluid Ozone, aging and weather resistant 	<ul style="list-style-type: none"> Superheated steam Acids and Alkalis Aromatic mineral oil Hydrocarbon-based fuels Aromatic hydrocarbons
I	Silicone HT (VMQ) Food Grade				
K	Ethylene Propylene Rubber (EPDM)	70	-70°F to +250°F (-57°C to +121°C)	<ul style="list-style-type: none"> Hot water Glycol based brake fluids Many organic and inorganic acids Cleaning agents Soda and potassium alkalis Phosphate ester based fluids Many polar solvents 	<ul style="list-style-type: none"> Petroleum oils and fluids Mineral oil products
L	Ethylene Propylene Rubber (EPDM)	80	-70°F to +250°F (-57°C to +121°C)		

06/01/2014

The following table is a list of back up ring materials for use with PTFE fluid power seals. List the corresponding back up ring material code in the appropriate location in the part number.

Table 3-6. Typical Application Ranges and Recommendations – Back-up Rings for PTFE Fluid Power Seals

Material Code	Material Description	Pressure Rating *	Temperature Range	Recommended Use
A	Nylon, Molybdenum Di-Sulfide Filled	7,500 psi (517 bar)	-65°F to +275°F (-54°C to +135°C)	<ul style="list-style-type: none"> Petroleum oils and fluids Diesel fuel and fuel oils Phosphate ester fluids Silicone oil and grease Mineral oil and grease
B	Nylon Glass Filled	7,500 psi (517 bar)	-65°F to +275°F (-54°C to +135°C)	<ul style="list-style-type: none"> Reduced water absorption Improved thermal stability
C	Acetal	6,000 psi (414 bar)	-40°F to +250°F (-40°C to +121°C)	<ul style="list-style-type: none"> HFA, HFB and HFC fluids Water Petroleum oils and fluids Diesel fuel and fuel oils Mineral oil and grease
D	PTFE PPS Filled	5000 psi (345 bar)	-100°F to +450°F (-73°C to +232°C)	<ul style="list-style-type: none"> Extended temperature, pressure and media resistance
E	PEEK Virgin	10,000 psi (690 bar)	-65°F to +500°F (-54°C to +260°C)	<ul style="list-style-type: none"> Extended temperature, pressure and media resistance

* Pressure ratings are a general guide only. Pressure ratings are reduced if wear rings are used.

Table 3-7. Standard (■) vs. Optional (□) Materials for PTFE Fluid Power Seal Profiles

PTFE Material Code	PTFE Fluid Power Seal Profile														
	S5	R5	CT	CQ	OE	CP	OA	OD	ON	CR	OC	AD	OQ	OR	OG
0100						□				□		□			
0102						□	■	□		□	■				□
0120	□	□			□	□		□	□	□			□	□	□
0203	■	■		□	□				□						
0204			□				□				□		□	□	
0205													■	■	
0301					□				□				□	□	
0307			□		□			□	□				□	□	□
0401	□	□	■	■	■	■		■	■	■	□	■			■
0502												□	□	□	
0601					□				□						

Chemical Compatibility

It is essential to select seal compounds that are compatible with the environment in which they are used. Even if the proper seal material is chosen based on system temperature and pressure, exposure to certain fluids can drastically reduce seal performance by altering a compound's typical physical properties.

Parker has tested thousands of fluids and is continuously testing many new, popular chemicals to ensure seal material compatibility. For detailed reports regarding compatibility of common seal materials and popular test fluids, please contact your local Parker Engineered Materials Group representative.

Temperature Limits

When selecting a seal material, temperature is a key factor. Heat affects the seal material in several ways:

- Softens the material which accelerates wear
- Accelerates any chemical reaction between the fluid and the seal
- Damages the bond structure of the material
- Increases compression set
- Higher temperatures for extended periods of time may harden thermoset (rubber) materials

Lower end temperature may be as important as the upper end temperature. This is especially true in mobile hydraulics. As the temperature lowers, the following takes place:

- The seal hardens and is less responsive.
- The coefficient of thermal expansion and contraction is approximately ten times that of metals. Therefore the seal lips could start to pull away from the surface of the bore. This loss of lip compression against the colder sealing surfaces can be offset by seal design and proper material selection.
- The opposite is also true. As a bearing or wear ring heats up, binding can occur if there is not a gap designed into the wear ring.

Storage and Handling

In 1998, the Society of Automotive Engineers (SAE) issued an Aerospace Recommended Practice (ARP) for the storage of elastomer seals and seal assemblies prior to installation. ARP 5316 has been considered by many as the industry standard; however, Parker has taken a conservative approach to ensure to our customers the highest quality. Both the ARP 5316 and Parker standards for shelf life are shown below in Table 3-8.

Table 3-8. Recommended Storage Standards

Chemical Name	Polymer	ARP 5316	Parker
Aflas®	FEPM	Unlimited	7 Years
Ethylene Propylene	EP, EPR, EPDM	Unlimited	7 Years
Fluorocarbon	FKM	Unlimited	7 Years
Nitrile	NBR, HNBR, XNBR	15 Years	7 Years
Polyurethane	AU or EU	—	10 Years
Polymyte®	TPCE	—	10 Years
Polytetra-fluoroethylene	PTFE	—	Unlimited

The values above assume that proper guidelines for storage conditions are followed. If plastic and rubber products are stored improperly, their physical properties may change. Prior to use, all parts should be checked for hardness, surface cracking or peeling. If any of these conditions are observed, the parts should be discarded. Some compounds can exhibit a build-up of powdery film on their surface over time. This natural occurrence is referred to as bloom and does not in any way negatively impact the function of the seal. Guidelines for proper seal storage are shown in [Table 3-9, page 3-21](#).

Table 3-9. Seal Storage and Handling Guidelines

Seal Storage and Handling Guidelines	
Records	Records should be kept to ensure that stock is rotated such that the first seals in are the first out (FIFO).
Temperature	Seals must be stored away from heat sources such as direct sunlight and heating appliances. Maximum storage temperature is +100°F (+38°C). Low temperatures do not typically cause permanent damage to seals, but can result in brittleness, making them susceptible to damage if not handled carefully. Ideally, seals should not be stored at temperatures less than +50°F (+10°C) and should be warmed to room temperature before installation.
Ultra Violet	Seal must be protected from direct sunlight and any artificial light that generates ultra violet radiation.
Humidity	Care should be taken to ensure seals are always stored in an environment with a relative humidity of less than 65%. Polyurethane seals in particular are very susceptible to damage from exposure to moisture and should be stored in air-tight containers.
Oxygen and Ozone	Ozone-generating equipment and oxygen exposure can be detrimental to seal compounds. Seals should be stored in air-tight containers. Any electrical equipment that generates a spark should not be used near seal storage.
Contamination	Keeping seals free from contamination will assist promote service life. Good housekeeping practices should be maintained.
Distortion	Large seals should be stored flat when possible and not suspended, which may cause distortion over time. Do not store seals on hooks, nails or pegboard.

Fluid Power Applications

Fluid Power Applications

This section illustrates Parker's recommended sealing system for various types of fluid power applications. Each component's individual features as well as the collective functions of all components in the system are taken into consideration in each recommendation.

Contents

Mobile Hydraulic Applications..... 4-2

Industrial Hydraulic Applications..... 4-6

Typical fluid power application sealing system components include:

Rod Seal – Rod seals are typically uni-directional seals. They are static on the outer diameter and dynamic on the inner diameter. These seals are installed into female glands on the bore and are used to seal fluid on a reciprocating rod. Rod seals can be loaded with energizers for low pressure sealing.

Buffer Seal – A buffer seal is a compact rod seal with a thick dynamic lip that is placed in front of a standard rod seal. The buffer seal shields the primary rod seal from pressure spikes, dramatically increasing seal efficiency. Buffer seals are designed to allow trapped fluid pressure between the buffer seal and primary rod seal to bleed back into the system.

Wiper – A wiper is designed to exclude contamination like dust and/or water from entering the system. Contamination causes 75% of hydraulic failures.

Piston Seal – A piston seal may provide uni-directional (single-acting), or bi-directional (double-acting) sealing. It is static on the inner diameter and dynamic on the outer diameter. These seals are installed on pistons that reciprocate along a bore of a cylinder.

Wear Ring – A wear ring prevents metal to metal contact caused by side loading in reciprocating applications; wear rings can be located inside the rod gland and/or on the piston.



Typical Hydraulic Cylinder

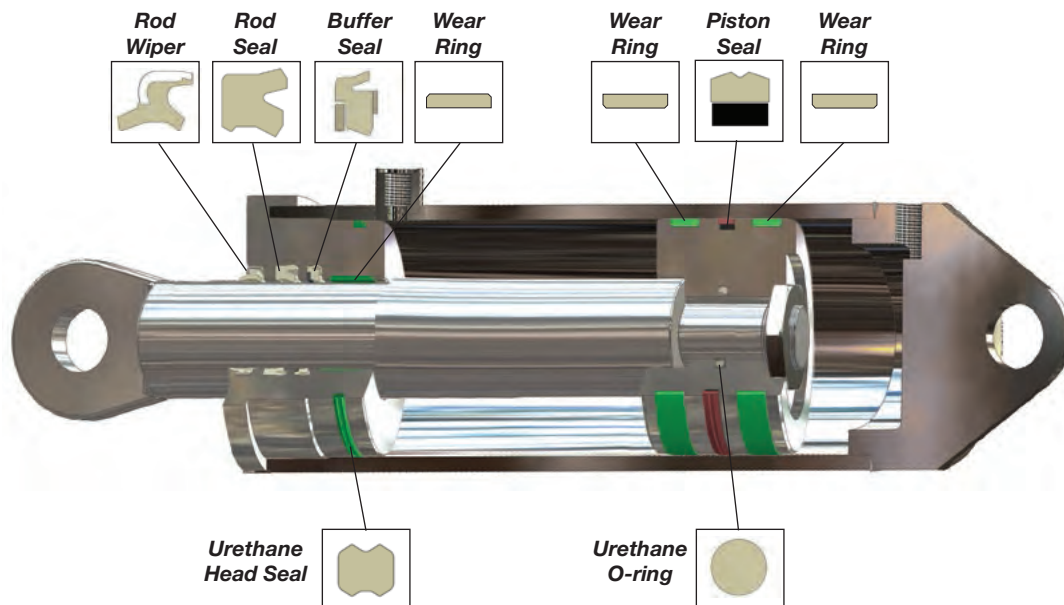

Mobile Hydraulic Applications

Catalog EPS 5370/USA

Excavators



4

Rod				Static	Piston	
Wiper	Primary	Buffer	Wear Ring	Head Seal	Wear Ring	Primary
AH Canned (non-vented design)	BT	BR	WRT	HS	WPT	OK
Materials						
4300	4300	4300	4733	4700	4733	4650

Agricultural Equipment



Rod			Static	Piston	
Wiper	Primary	Wear Ring	Head Seal	Wear Ring	Primary
SHD	BD	WRT	HS	WPT	PSP
Materials					
5065	5065	4733	4700	4733	4622

Aerial Man Lifts



Rod			Static	Piston	
Wiper	Primary	Wear Ring	Head Seal	Wear Ring	Primary
YD	BD	WRT	HS	WPT	BP
Materials					
4300	4300	4733	4700	4733	4304

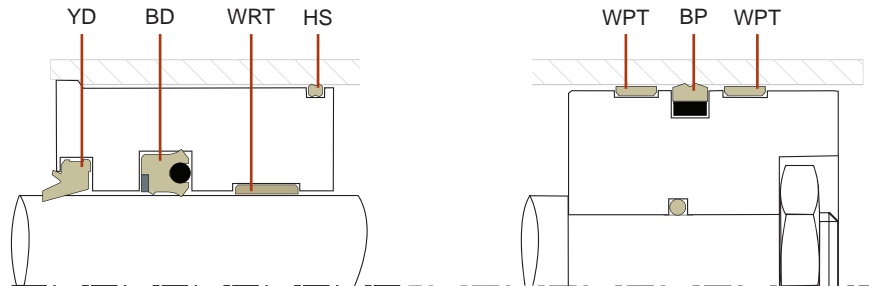

Material Handling / Fork Lifts



Rod				Static	Piston	
Wiper	Primary	Buffer	Wear Ring	Head Seal	Wear Ring	Primary
AY	BT	BR	WRT	HS	WPT	BP
Materials						
4300	4300	4300	4733	4700	WPT	4304

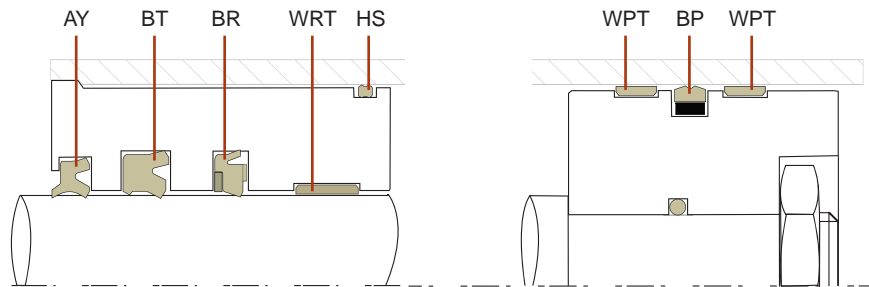

Earth Moving Wheel Loaders / Bulldozers / Backhoes



4

Rod				Static	Piston	
Wiper	Primary	Buffer	Wear Ring	Head Seal	Wear Ring	Primary
J	BT	BR	WRT	HS	WPT	CT
Materials						
4700	4300	4300	4733	4700	4733	0401

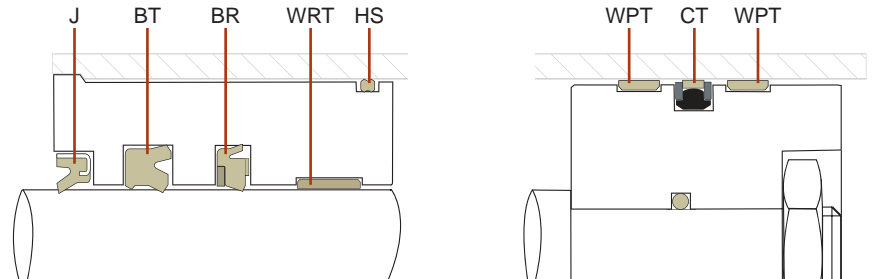

Skid Steers



Rod				Static	Piston	
Wiper	Primary	Buffer	Wear Ring	Head Seal	Wear Ring	Primary
YD	BT	BR	WRT	HS	WPT	BP
Materials						
4300	4300	4300	4733	4700	4733	4304

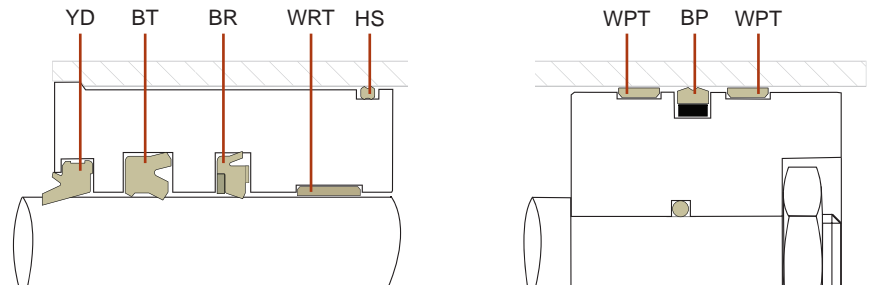

Mining Truck Struts/Shocks



Wiper		Rod			Static		Piston	
J	BT	BR	Buffer BR	Wear Ring WRT	Head Seal HS	Wear Ring WRT	Wear Ring WPT	Primary BP
4300	4300	4300	4300	4733	4700	4733	4733	4304

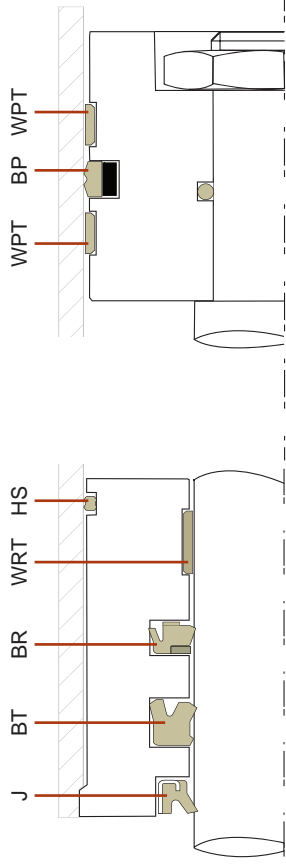

Accumulators: Mobile and Industrial

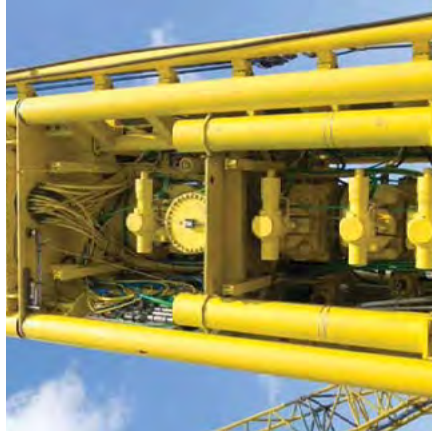

Piston		Primary	
Wear Ring	WPT	OG	TP
Materials	4733	0401	4115, B001

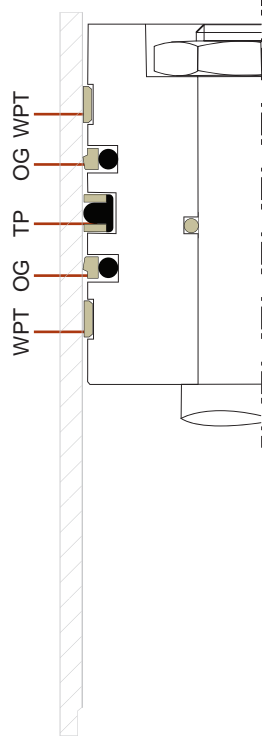

Flow Control: Cartridge Valves and Spool Valves



Piston		O-Ring	
Primary	DG	568	
Materials	4300/4301	4300/4301	

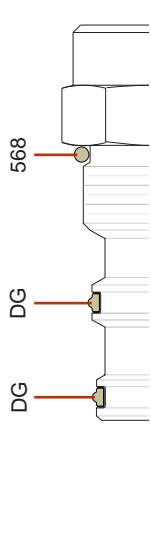

Industrial Hydraulic Applications

Catalog EPS 5370/USA

General Purpose: Environmentally Friendly Fluid – Water-Based – Cylinders

4



Rod				Static	Piston	
Wiper	Primary	Buffer	Wear Ring	Head Seal	Wear Ring	Primary
YD	BT	BR	WRT	HS	WPT	OE
Materials						
4301	4301	4301	0810	4301	0810, PEEK, PTFE, Composite	0401

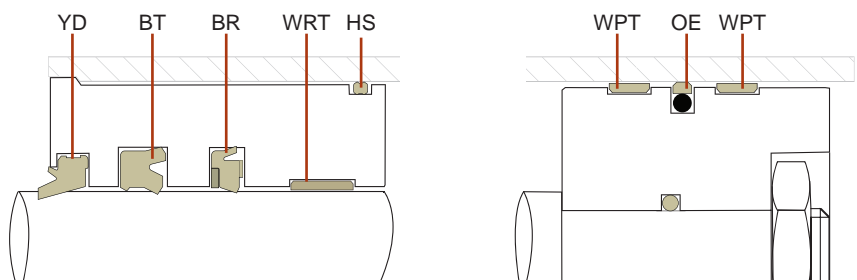

Power Generation



Rod				Static	Piston	
Wiper	Primary	Buffer	Wear Ring	Head Seal	Wear Ring	Primary
YD	BT	BR	WRT	HS	WPT	BP
Materials						
4300/ 4301	4300/ 4301	4300/ 4301	4733	4700	4733	4304

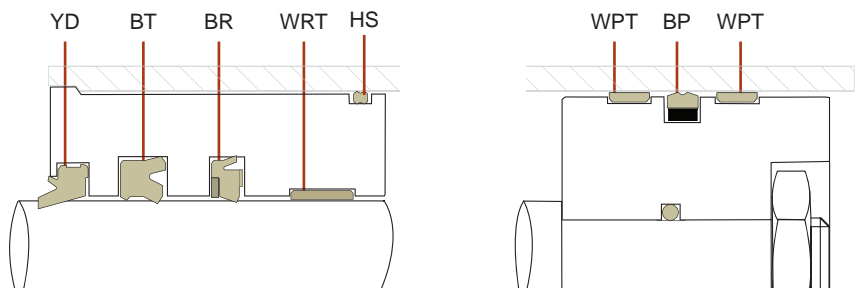

06/01/2014

Click to Go to
CATALOG
Table of Contents

Click to Go to
SECTION
Table of Contents

Pneumatic Cylinders



Rod		Static		Piston	
Wiper	Primary	Wear Ring	Head Seal	Primary	Wear Ring
8600	8400	PDW	HS	8500	PDW
Materials					
4181	4180	0307	4700	4180	0307

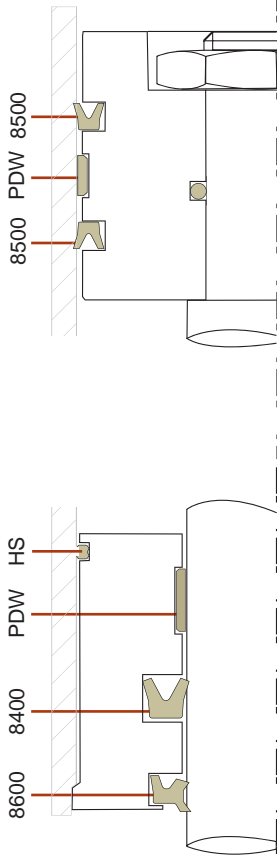

Rod Seals

Contents

Product Offering 5-2
 Decision Tree 5-3
 Rod Seal Profiles

- ◆ BD 5-5
- ◆ BT 5-13
- ◆ BR 5-17
- B3 5-21
- BS 5-23
- UR 5-25
- E5 5-27
- TR 5-29
- ON 5-32
- CR 5-34
- OC 5-36
- OD 5-38
- V6 5-40
- OR 5-42

Rod Seals

Parker offers a wide range of hydraulic and pneumatic rod seal profiles to meet the broad demands of the fluid power industry. These rod seals are offered in a variety of compounds and lip geometries for the best possible solution for a given application. A majority of Parker rod seals are manufactured utilizing a precision knife trim process to ensure the sealing contact with the dynamic surface yields the best possible performance. When combined with other Parker profiles, including wear rings, buffer seals, wipers, and static gland seals, Parker rod seals have proven to provide long life and leak free performance.

Typical Hydraulic Cylinder

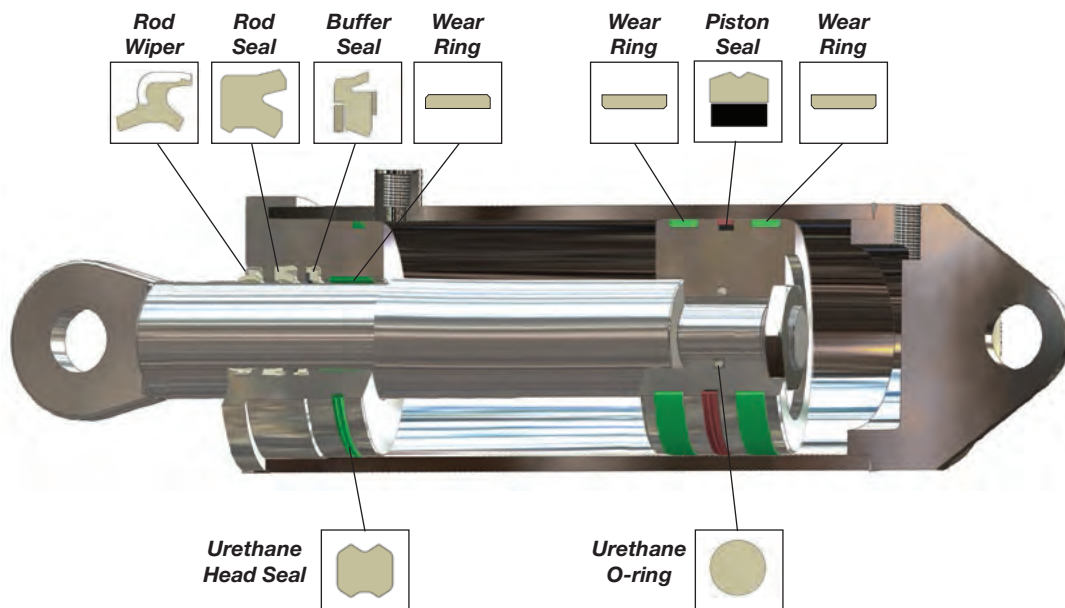















































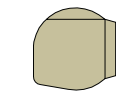

Rod Seal Product Offering

Catalog EPS 5370/USA

Profiles

Table 5-1: Product Profiles

 = Preferred Rod Seal profile

Series	Description	Application (Duty)				Page	Series	Description	Application (Duty)				Page
		Light	Medium	Heavy	Pneumatic				Light	Medium	Heavy	Pneumatic	
BD 	Premium O-ring Energized Lip Seal					5-5	TR 	Compact Seal with Anti-Extrusion Technology					5-29
	BD Profile with back-up					5-9							
BT 	Premium U-cup Rod Seal with Secondary Stabilizing Lip					5-13	ON 	PTFE Cap Rod Seal					5-32
													
BR 	Premium Buffer Seal					5-17	CR 	PTFE Cap Rod Seal to Retrofit O-ring Glands					5-34
													
B3 	U-cup Rod Seal					5-21	OC 	Compact PTFE Cap Rod Seal					5-36
													
BS 	U-cup Rod Seal with Secondary Stabilizing Lip					5-23	OD 	PTFE Buffer Seal					5-38
													
UR 	Industrial U-cup Rod Seal					5-25	V6 	Cushion Seal					5-40
													
E5 	Premium Rounded Lip U-cup Rod Seal					5-27	OR 	PTFE Cap Rotary Seal					5-42
													

5

Rod Seal Decision Tree

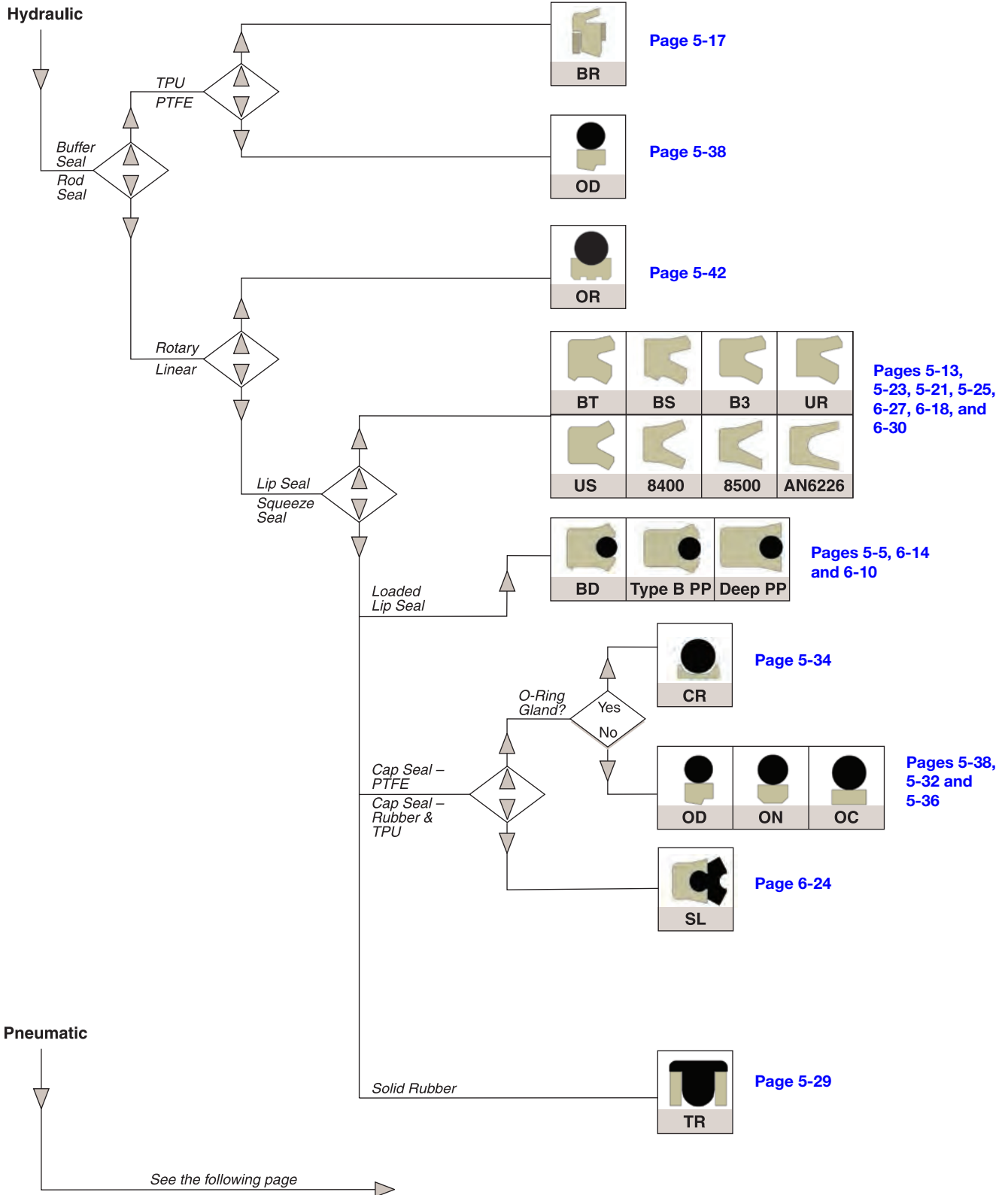

Non-Symmetrical Rod Decision Tree (continued)

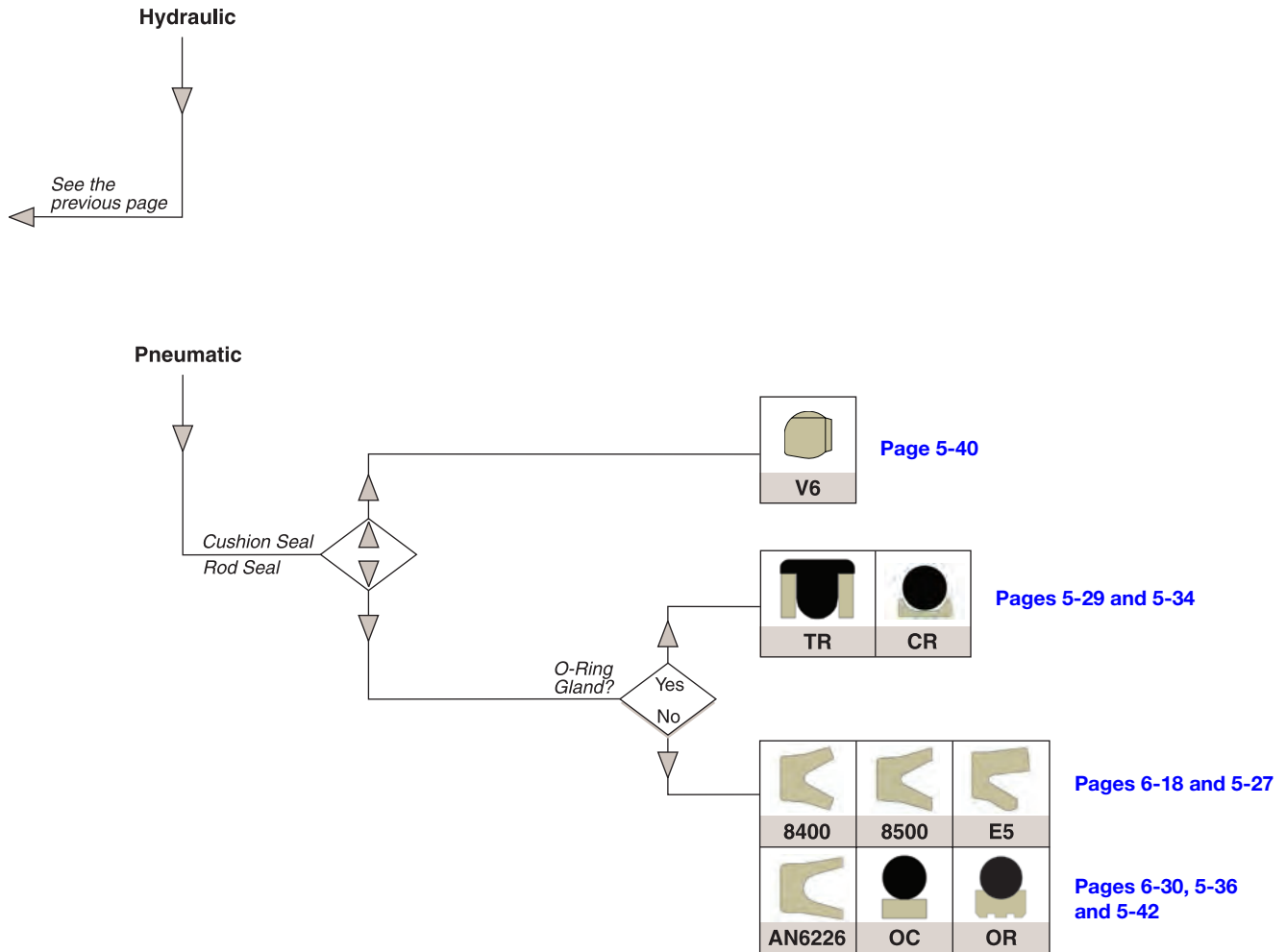

5

Rod Seal BD Profile

◆ Preferred Profile

Catalog EPS 5370/USA

BD Profile, Premium O-ring Energized Lip Seal

The BD profile is a non-symmetrical profile rod seal. Its rectangular shaped cross section ensures stability in the gland. The o-ring energizer functions as a spring to maintain sealing contact under low pressure or vacuum applications. The knife trimmed, beveled lip does an excellent job wiping fluid film. A stabilizing lip is located below the primary sealing lip, just above the base of the seal, to provide enhanced sealing performance and ensure a tight, stable fit in the gland. Available in Parker's proprietary urethanes, the BD profile provides long life, extrusion resistance, low compression set, shock load resistance and increased sealing performance at zero pressure. The BD profile is designed to be used as a stand alone rod seal or for use with the BR or OD profile buffer seal for more critical sealing applications.



Technical Data

Standard Materials	Temperature Range	Pressure Range	Surface Speed
P4300A90	-65°F to +275°F (-54°C to +135°C)	5000 psi (344 bar)	< 1.6 ft/s (0.5 m/s)
P4301A90	-65°F to +275°F (-54°C to +135°C)	5000 psi (344 bar)	< 1.6 ft/s (0.5 m/s)

Alternate Materials: For applications that may require an alternate material, please go to www.parker.com/eps/FluidPower to check current tooling and part number availability, or contact your local Parker representative.

†**Pressure Range** without wear rings. If used with wear rings, see [Table 2-4, page 2-5](#).



BD Cross-Section

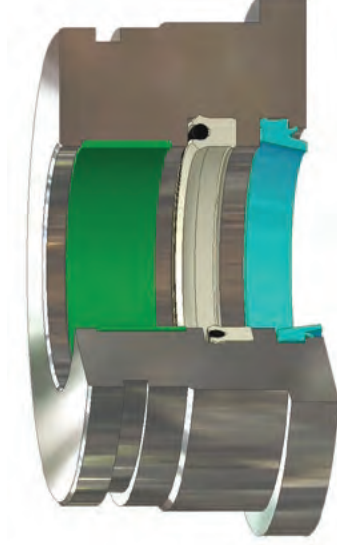

BD Installed in Rod Gland

Part Number Nomenclature – BD Profile (4300, No-Back-up)

Table 5-2. BD Profile – 4300 Material, No Back-up

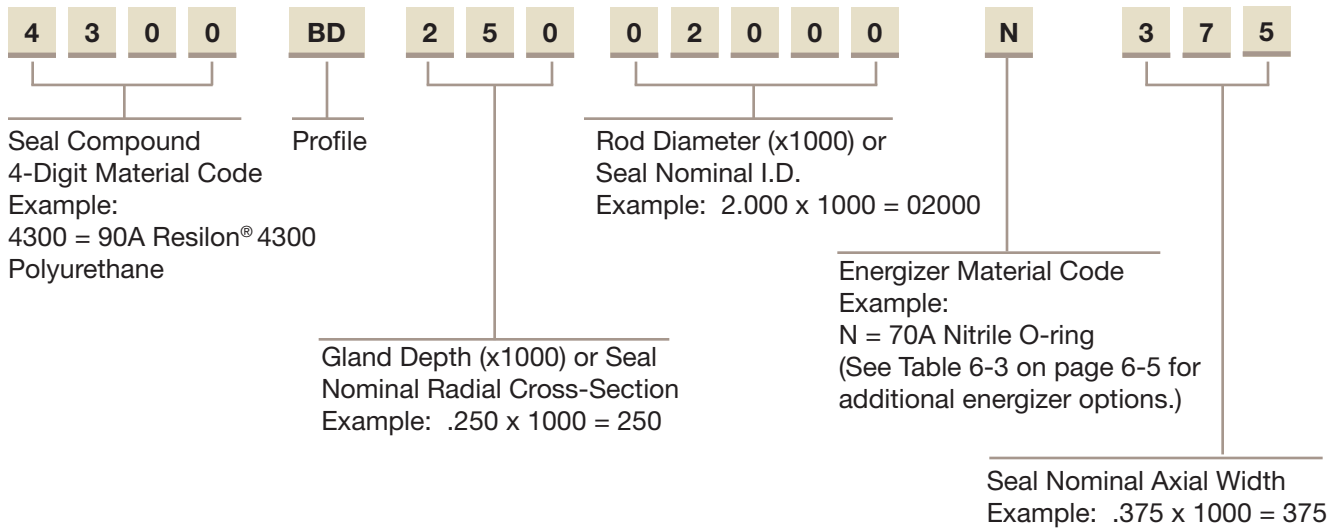

5

Gland Dimensions – BD Profile

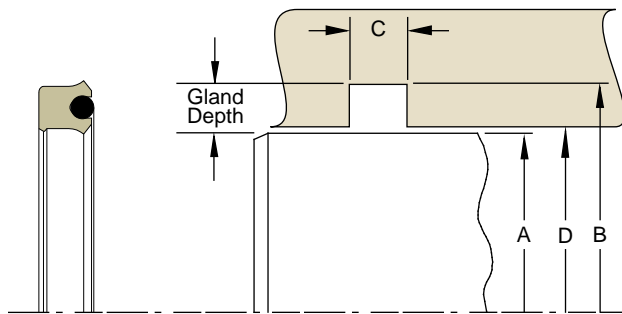

Please refer to [Engineering Section 2, page 2-8](#) for surface finish and additional hardware considerations.

Table 5-3. BD Profile – Rod Gland Calculation

A Rod Diameter		Seal		B Groove Diameter		C Groove Width	D Throat Diameter*	
Range	Tol.	Cross Section	Axial Width	Calculation	Tol.	+0.015/-0.000	Calculation	Tol.
0.250 - 0.624	+0.000/-0.001	1/8 (.125)	3/16 (.187)	Dia. A + .250	+0.002/-0.000	0.206	Dia. A + .002	+0.002/-0.000
0.625 - 0.999	+0.000/-0.001	1/8 (.125)	1/4 (.250)	Dia. A + .250	+0.002/-0.000	0.275	Dia. A + .002	+0.002/-0.000
1.000 - 1.499	+0.000/-0.002	3/16 (.187)	5/16 (.312)	Dia. A + .375	+0.002/-0.000	0.343	Dia. A + .002	+0.002/-0.000
1.500 - 1.999	+0.000/-0.002	3/16 (.187)	3/8 (.375)	Dia. A + .375	+0.002/-0.000	0.413	Dia. A + .002	+0.002/-0.000
2.000 - 3.499	+0.000/-0.002	1/4 (.250)	3/8 (.375)	Dia. A + .500	+0.003/-0.000	0.413	Dia. A + .003	+0.003/-0.000
3.500 - 4.999	+0.000/-0.002	5/16 (.312)	1/2 (.500)	Dia. A + .625	+0.004/-0.000	0.550	Dia. A + .003	+0.003/-0.000
5.000 - 9.499	+0.000/-0.002	3/8 (.375)	5/8 (.625)	Dia. A + .750	+0.005/-0.000	0.688	Dia. A + .004	+0.004/-0.000
9.500 - 10.000	+0.000/-0.003	1/2 (.500)	3/4 (.750)	Dia. A + 1.000	+0.007/-0.000	0.825	Dia. A + .005	+0.005/-0.000

*If used with wear rings, refer to wear ring throat diameter, see [Section 9](#). For custom groove calculations, see [Appendix C](#).

Above table reflects recommended cross-sections for rod diameters shown. Alternate cross-sections and additional sizes may be considered. Consult www.parker.com/eps/FluidPower for additional cross-sections and sizes, hardware specifications, and part number availability. Contact your Parker representative for assistance.

Gland Dimensions — BD Profile (4300, No-Back-up)
Table 5-4. BD Profile — Rod Gland Dimensions, ♦Parker Standard Sizes

Hardware Dimensions										Part Number
A Rod Diameter		B Groove Diameter		C Groove Width	D Throat Diameter*					
Dia.	Tol.	Dia.	Tol.	+0.015/-0.000	Dia.	Tol.	Dia.	Tol.		
0.250	+0.00/-0.01	0.500	+0.02/-0.00	0.206	0.252	+0.02/-0.00	4300BD12500250N187			
0.312	+0.00/-0.01	0.562	+0.02/-0.00	0.206	0.314	+0.02/-0.00	4300BD12500312N187			
0.375	+0.00/-0.01	0.625	+0.02/-0.00	0.206	0.377	+0.02/-0.00	4300BD12500375N187			
0.437	+0.00/-0.01	0.687	+0.02/-0.00	0.206	0.439	+0.02/-0.00	4300BD12500437N187			
0.500	+0.00/-0.01	0.750	+0.02/-0.00	0.206	0.502	+0.02/-0.00	4300BD12500500N187			
0.625	+0.00/-0.01	0.875	+0.02/-0.00	0.275	0.627	+0.02/-0.00	4300BD12500625N250			
0.750	+0.00/-0.01	1.000	+0.02/-0.00	0.275	0.752	+0.02/-0.00	4300BD12500750N250			
0.875	+0.00/-0.01	1.125	+0.02/-0.00	0.275	0.877	+0.02/-0.00	4300BD12500875N250			
1.000	+0.00/-0.02	1.375	+0.02/-0.00	0.343	1.002	+0.02/-0.00	4300BD18701000N312			
1.125	+0.00/-0.02	1.500	+0.02/-0.00	0.343	1.127	+0.02/-0.00	4300BD18701125N312			
1.250	+0.00/-0.02	1.625	+0.02/-0.00	0.343	1.252	+0.02/-0.00	4300BD18701250N312			
1.375	+0.00/-0.02	1.750	+0.02/-0.00	0.343	1.377	+0.02/-0.00	4300BD18701375N312			
1.500	+0.00/-0.02	1.875	+0.02/-0.00	0.413	1.502	+0.02/-0.00	4300BD18701500N375			
1.625	+0.00/-0.02	2.000	+0.02/-0.00	0.413	1.627	+0.02/-0.00	4300BD18701625N375			
1.750	+0.00/-0.02	2.125	+0.02/-0.00	0.413	1.752	+0.02/-0.00	4300BD18701750N375			
1.875	+0.00/-0.02	2.250	+0.02/-0.00	0.413	1.877	+0.02/-0.00	4300BD18701875N375			
2.000	+0.00/-0.02	2.500	+0.03/-0.00	0.413	2.003	+0.03/-0.00	4300BD25002000N375			
2.125	+0.00/-0.02	2.625	+0.03/-0.00	0.413	2.128	+0.03/-0.00	4300BD25002125N375			
2.250	+0.00/-0.02	2.750	+0.03/-0.00	0.413	2.253	+0.03/-0.00	4300BD25002250N375			
2.375	+0.00/-0.02	2.875	+0.03/-0.00	0.413	2.378	+0.03/-0.00	4300BD25002375N375			
2.500	+0.00/-0.02	3.000	+0.03/-0.00	0.413	2.503	+0.03/-0.00	4300BD25002500N375			
2.625	+0.00/-0.02	3.125	+0.03/-0.00	0.413	2.628	+0.03/-0.00	4300BD25002625N375			
2.750	+0.00/-0.02	3.250	+0.03/-0.00	0.413	2.753	+0.03/-0.00	4300BD25002750N375			
3.000	+0.00/-0.02	3.500	+0.03/-0.00	0.413	3.003	+0.03/-0.00	4300BD25003000N375			
3.250	+0.00/-0.02	3.750	+0.03/-0.00	0.413	3.253	+0.03/-0.00	4300BD25003250N375			
3.500	+0.00/-0.02	4.125	+0.04/-0.00	0.550	3.503	+0.03/-0.00	4300BD31203500N500			
3.750	+0.00/-0.02	4.375	+0.04/-0.00	0.550	3.753	+0.03/-0.00	4300BD31203750N500			
4.000	+0.00/-0.02	4.625	+0.04/-0.00	0.550	4.003	+0.03/-0.00	4300BD31204000N500			
4.250	+0.00/-0.02	4.875	+0.04/-0.00	0.550	4.253	+0.03/-0.00	4300BD31204250N500			
4.500	+0.00/-0.02	5.125	+0.04/-0.00	0.550	4.503	+0.03/-0.00	4300BD31204500N500			
4.750	+0.00/-0.02	5.375	+0.04/-0.00	0.550	4.753	+0.03/-0.00	4300BD31204750N500			
5.000	+0.00/-0.02	5.750	+0.05/-0.00	0.688	5.004	+0.04/-0.00	4300BD37505000N625			
5.500	+0.00/-0.02	6.250	+0.05/-0.00	0.688	5.504	+0.04/-0.00	4300BD37505500N625			
6.000	+0.00/-0.02	6.750	+0.05/-0.00	0.688	6.004	+0.04/-0.00	4300BD37506000N625			
6.500	+0.00/-0.02	7.250	+0.05/-0.00	0.688	6.504	+0.04/-0.00	4300BD37506500N625			
7.000	+0.00/-0.02	7.750	+0.05/-0.00	0.688	7.004	+0.04/-0.00	4300BD37507000N625			
7.500	+0.00/-0.03	8.500	+0.07/-0.00	0.825	7.505	+0.05/-0.00	4300BD50007500N750			

*If used with wear rings, refer to wear ring throat diameter, see [Section 9](#). For custom groove calculations, see [Appendix C](#).

Above table reflects recommended cross-sections for rod diameters shown. Alternate cross-sections and additional sizes may be considered. Consult www.parker.com/eps/FluidPower for additional cross-sections and sizes, hardware specifications, and part number availability. Contact your Parker representative for assistance.

Gland Dimensions – BD Profile (4300, No Back-up)

Table 5-4. BD Profile – Rod Gland Dimensions, ♦Parker Standard Sizes (cont'd)

Hardware Dimensions							Part Number
A Rod Diameter		B Groove Diameter		C Groove Width	D Throat Diameter*		
Dia.	Tol.	Dia.	Tol.	+0.015/-0.000	Dia.	Tol.	
8.000	+0.000/-0.003	9.000	+0.007/-0.000	0.825	8.005	+0.005/-0.000	4300BD50008000N750
8.500	+0.000/-0.003	9.500	+0.007/-0.000	0.825	8.500	+0.005/-0.000	4300BD50008500N750
9.000	+0.000/-0.003	10.000	+0.007/-0.000	0.825	9.000	+0.005/-0.000	4300BD50009000N750
9.500	+0.000/-0.003	10.500	+0.007/-0.000	0.825	9.500	+0.005/-0.000	4300BD50009500N750
10.000	+0.000/-0.003	11.000	+0.007/-0.000	0.825	10.000	+0.005/-0.000	4300BD50010000N750

*If used with wear rings, refer to wear ring throat diameter, see [Section 9](#). For custom groove calculations, see [Appendix C](#).

Above table reflects recommended cross-sections for rod diameters shown. Alternate cross-sections and additional sizes may be considered. Consult www.parker.com/eps/FluidPower for additional cross-sections and sizes, hardware specifications, and part number availability. Contact your Parker representative for assistance.

Rod Seal BD Profile

◆ Preferred Profile

Catalog EPS 5370/USA

BD Profile, Premium O-ring Energized Lip Seal With Back-up Ring



For enhanced extrusion protection, Parker offers the BD profile with a positively actuated back-up ring located in the heel. See part number nomenclature for designating this option.

The BD profile is a non-symmetrical profile rod seal. Its rectangular shaped cross section ensures stability in the gland. The o-ring energizer functions as a spring to maintain sealing contact under low pressure or vacuum applications. The knife trimmed, beveled lip does an excellent job wiping fluid film. A stabilizing lip is located below the primary sealing lip, just above the base of the seal, to provide enhanced sealing performance and ensure a tight, stable fit in the gland. Available in Parker's proprietary urethanes, the BD profile provides long life, extrusion resistance, low compression set, shock load resistance and increased sealing performance at zero pressure. The BD profile is designed to be used as a stand alone rod seal or for use with the BR or OD profile buffer seal for more critical sealing applications.

5

Technical Data

Standard Materials	Temperature Range	Pressure Range*	Surface Speed
P5065A88	-70°F to +200°F (-57°C to +93°C)	3500 psi (241 bar)	< 1.6 ft/s (0.5 m/s)
Back-up W4655NHH	-65°F to +250°F (-54°C to +93°C)	10,000 psi (688 bar)	< 1.6 ft/s (0.5 m/s)

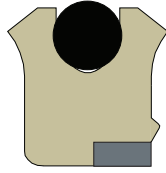

BD Cross-Section
with Back-up

Alternate Materials: For applications that may require an alternate material, please go to www.parker.com/eps/FluidPower to check current tooling and part number availability, or contact your local Parker representative.

***Pressure Range** without wear rings. If used with wear rings, see [Table 2-4, page 2-5](#).

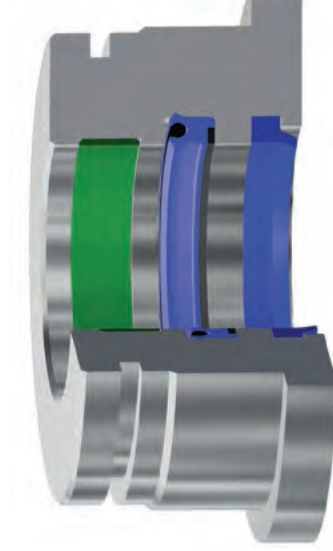

BD Installed in Rod Gland

06/01/2014

Part Number Nomenclature – BD Profile (5065, with Back-up)

Table 5-5. BD Profile

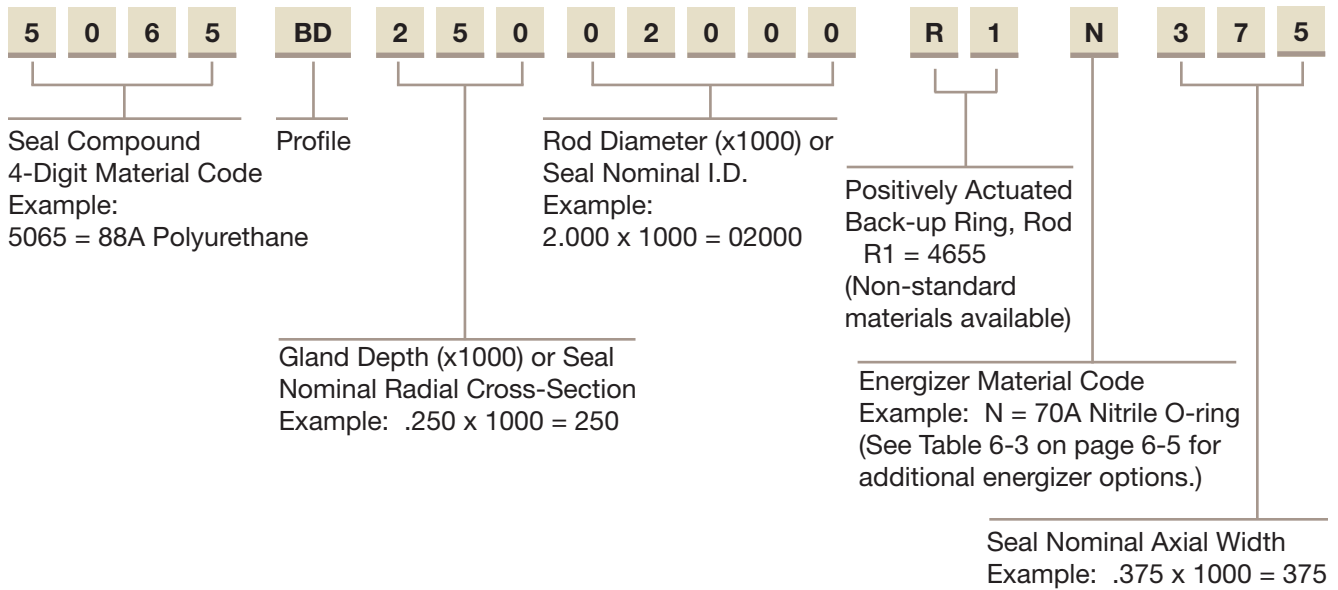

5

Gland Dimensions – BD Profile

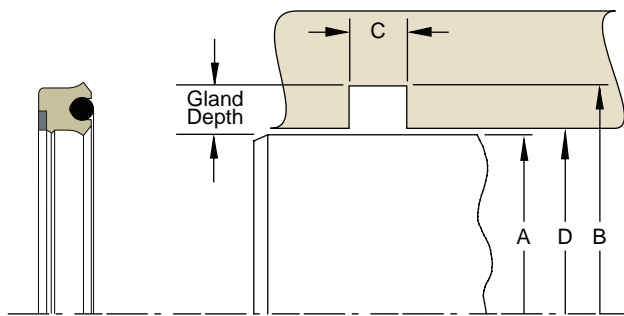

Please refer to [Engineering Section 2, page 2-8](#) for surface finish and additional hardware considerations.

Table 5-6. BD Profile – Rod Gland Calculation

A Rod Diameter		Seal		B Groove Diameter		C Groove Width	D Throat Diameter*	
Range	Tol.	Cross Section	Axial Width	Calculation	Tol.	+0.015/-0.000	Calculation	Tol.
0.250 - 0.624	+0.000/-0.001	1/8 (.125)	3/16 (.187)	Dia. A + .250	+0.002/-0.000	0.206	Dia. A + .002	+0.002/-0.000
0.625 - 0.999	+0.000/-0.001	1/8 (.125)	1/4 (.250)	Dia. A + .250	+0.002/-0.000	0.275	Dia. A + .002	+0.002/-0.000
1.000 - 1.499	+0.000/-0.002	3/16 (.187)	5/16 (.312)	Dia. A + .375	+0.002/-0.000	0.343	Dia. A + .002	+0.002/-0.000
1.500 - 1.999	+0.000/-0.002	3/16 (.187)	3/8 (.375)	Dia. A + .375	+0.002/-0.000	0.413	Dia. A + .002	+0.002/-0.000
2.000 - 3.499	+0.000/-0.002	1/4 (.250)	3/8 (.375)	Dia. A + .500	+0.003/-0.000	0.413	Dia. A + .003	+0.003/-0.000
3.500 - 4.999	+0.000/-0.002	5/16 (.312)	1/2 (.500)	Dia. A + .625	+0.004/-0.000	0.550	Dia. A + .003	+0.003/-0.000
5.000 - 9.499	+0.000/-0.002	3/8 (.375)	5/8 (.625)	Dia. A + .750	+0.005/-0.000	0.688	Dia. A + .004	+0.004/-0.000
9.500 - 10.000	+0.000/-0.003	1/2 (.500)	3/4 (.750)	Dia. A + 1.000	+0.007/-0.000	0.825	Dia. A + .005	+0.005/-0.000

*If used with wear rings, refer to wear ring throat diameter, see [Section 9](#). For custom groove calculations, see [Appendix C](#).

Above table reflects recommended cross-sections for rod diameters shown. Alternate cross-sections and additional sizes may be considered. Consult www.parker.com/eps/FluidPower for additional cross-sections and sizes, hardware specifications, and part number availability. Contact your Parker representative for assistance.

06/01/2014

Gland Dimensions — BD Profile (5065, with Back-up)
Table 5-7. BD Profile — Rod Gland Dimensions, ♦Parker Standard Sizes

Hardware Dimensions										Part Number
A Rod Diameter		B Groove Diameter		C Groove Width		D Throat Diameter*		D Throat Diameter*		
		Dia.	Tol.	Dia.	Tol.	Dia.	Tol.			
0.250	+0.00/-0.01	0.500	+0.02/-0.00	0.206	+0.015/-0.00	0.252	+0.02/-0.00	0.252	+0.02/-0.00	5065BD12500250R1N187
0.312	+0.00/-0.01	0.562	+0.02/-0.00	0.206	+0.015/-0.00	0.314	+0.02/-0.00	0.314	+0.02/-0.00	5065BD12500312R1N187
0.375	+0.00/-0.01	0.625	+0.02/-0.00	0.206	+0.015/-0.00	0.377	+0.02/-0.00	0.377	+0.02/-0.00	5065BD12500375R1N187
0.437	+0.00/-0.01	0.687	+0.02/-0.00	0.206	+0.015/-0.00	0.439	+0.02/-0.00	0.439	+0.02/-0.00	5065BD12500437R1N187
0.500	+0.00/-0.01	0.750	+0.02/-0.00	0.206	+0.015/-0.00	0.502	+0.02/-0.00	0.502	+0.02/-0.00	5065BD12500500R1N187
0.625	+0.00/-0.01	0.875	+0.02/-0.00	0.275	+0.015/-0.00	0.627	+0.02/-0.00	0.627	+0.02/-0.00	5065BD12500625R1N250
0.750	+0.00/-0.01	1.000	+0.02/-0.00	0.275	+0.015/-0.00	0.752	+0.02/-0.00	0.752	+0.02/-0.00	5065BD12500750R1N250
0.875	+0.00/-0.01	1.125	+0.02/-0.00	0.275	+0.015/-0.00	0.877	+0.02/-0.00	0.877	+0.02/-0.00	5065BD12500875R1N250
1.000	+0.00/-0.02	1.375	+0.02/-0.00	0.343	+0.015/-0.00	1.002	+0.02/-0.00	1.002	+0.02/-0.00	5065BD18701000R1N312
1.125	+0.00/-0.02	1.500	+0.02/-0.00	0.343	+0.015/-0.00	1.127	+0.02/-0.00	1.127	+0.02/-0.00	5065BD18701125R1N312
1.250	+0.00/-0.02	1.625	+0.02/-0.00	0.343	+0.015/-0.00	1.252	+0.02/-0.00	1.252	+0.02/-0.00	5065BD18701250R1N312
1.375	+0.00/-0.02	1.750	+0.02/-0.00	0.343	+0.015/-0.00	1.377	+0.02/-0.00	1.377	+0.02/-0.00	5065BD18701375R1N312
1.500	+0.00/-0.02	1.875	+0.02/-0.00	0.413	+0.015/-0.00	1.502	+0.02/-0.00	1.502	+0.02/-0.00	5065BD18701500R1N375
1.625	+0.00/-0.02	2.000	+0.02/-0.00	0.413	+0.015/-0.00	1.627	+0.02/-0.00	1.627	+0.02/-0.00	5065BD18701625R1N375
1.750	+0.00/-0.02	2.125	+0.02/-0.00	0.413	+0.015/-0.00	1.752	+0.02/-0.00	1.752	+0.02/-0.00	5065BD18701750R1N375
1.875	+0.00/-0.02	2.250	+0.02/-0.00	0.413	+0.015/-0.00	1.877	+0.02/-0.00	1.877	+0.02/-0.00	5065BD18701875R1N375
2.000	+0.00/-0.02	2.500	+0.03/-0.00	0.413	+0.015/-0.00	2.003	+0.03/-0.00	2.003	+0.03/-0.00	5065BD25002000R1N375
2.125	+0.00/-0.02	2.625	+0.03/-0.00	0.413	+0.015/-0.00	2.128	+0.03/-0.00	2.128	+0.03/-0.00	5065BD25002125R1N375
2.250	+0.00/-0.02	2.750	+0.03/-0.00	0.413	+0.015/-0.00	2.253	+0.03/-0.00	2.253	+0.03/-0.00	5065BD25002250R1N375
2.375	+0.00/-0.02	2.875	+0.03/-0.00	0.413	+0.015/-0.00	2.378	+0.03/-0.00	2.378	+0.03/-0.00	5065BD25002375R1N375
2.500	+0.00/-0.02	3.000	+0.03/-0.00	0.413	+0.015/-0.00	2.503	+0.03/-0.00	2.503	+0.03/-0.00	5065BD25002500R1N375
2.625	+0.00/-0.02	3.125	+0.03/-0.00	0.413	+0.015/-0.00	2.628	+0.03/-0.00	2.628	+0.03/-0.00	5065BD25002625R1N375
2.750	+0.00/-0.02	3.250	+0.03/-0.00	0.413	+0.015/-0.00	2.753	+0.03/-0.00	2.753	+0.03/-0.00	5065BD25002750R1N375
3.000	+0.00/-0.02	3.500	+0.03/-0.00	0.413	+0.015/-0.00	3.003	+0.03/-0.00	3.003	+0.03/-0.00	5065BD25003000R1N375
3.250	+0.00/-0.02	3.750	+0.03/-0.00	0.413	+0.015/-0.00	3.253	+0.03/-0.00	3.253	+0.03/-0.00	5065BD25003250R1N375
3.500	+0.00/-0.02	4.125	+0.04/-0.00	0.550	+0.015/-0.00	3.503	+0.03/-0.00	3.503	+0.03/-0.00	5065BD31203500R1N500
3.750	+0.00/-0.02	4.375	+0.04/-0.00	0.550	+0.015/-0.00	3.753	+0.03/-0.00	3.753	+0.03/-0.00	5065BD31203750R1N500
4.000	+0.00/-0.02	4.625	+0.04/-0.00	0.550	+0.015/-0.00	4.003	+0.03/-0.00	4.003	+0.03/-0.00	5065BD31204000R1N500
4.250	+0.00/-0.02	4.875	+0.04/-0.00	0.550	+0.015/-0.00	4.253	+0.03/-0.00	4.253	+0.03/-0.00	5065BD31204250R1N500
4.500	+0.00/-0.02	5.125	+0.04/-0.00	0.550	+0.015/-0.00	4.503	+0.03/-0.00	4.503	+0.03/-0.00	5065BD31204500R1N500
4.750	+0.00/-0.02	5.375	+0.04/-0.00	0.550	+0.015/-0.00	4.753	+0.03/-0.00	4.753	+0.03/-0.00	5065BD31204750R1N500
5.000	+0.00/-0.02	5.750	+0.05/-0.00	0.688	+0.015/-0.00	5.004	+0.04/-0.00	5.004	+0.04/-0.00	5065BD37505000R1N625
5.500	+0.00/-0.02	6.250	+0.05/-0.00	0.688	+0.015/-0.00	5.504	+0.04/-0.00	5.504	+0.04/-0.00	5065BD37505500R1N625
6.000	+0.00/-0.02	6.750	+0.05/-0.00	0.688	+0.015/-0.00	6.004	+0.04/-0.00	6.004	+0.04/-0.00	5065BD37506000R1N625
6.500	+0.00/-0.02	7.250	+0.05/-0.00	0.688	+0.015/-0.00	6.504	+0.04/-0.00	6.504	+0.04/-0.00	5065BD37506500R1N625
7.000	+0.00/-0.02	7.750	+0.05/-0.00	0.688	+0.015/-0.00	7.004	+0.04/-0.00	7.004	+0.04/-0.00	5065BD37507000R1N625

*If used with wear rings, refer to wear ring throat diameter, see [Section 9](#). For custom groove calculations, see [Appendix C](#).

Above table reflects recommended cross-sections for rod diameters shown. Alternate cross-sections and additional sizes may be considered. Consult www.parker.com/eps/FluidPower for additional cross-sections and sizes, hardware specifications, and part number availability. Contact your Parker representative for assistance.

Gland Dimensions – BD Profile (5065, With Back-up)**Table 5-7. BD Profile – Rod Gland Dimensions, ♦Parker Standard Sizes (cont'd)**

Hardware Dimensions							Part Number
A Rod Diameter		B Groove Diameter		C Groove Width	D Throat Diameter*		
Dia.	Tol.	Dia.	Tol.	+0.015/-0.000	Dia.	Tol.	
7.500	+0.000/-0.003	8.500	+0.007/-0.000	0.825	7.505	+0.005/-0.000	5065BD50007500R1N750
8.000	+0.000/-0.003	9.000	+0.007/-0.000	0.825	8.005	+0.005/-0.000	5065BD50008000R1N750
8.500	+0.000/-0.003	9.500	+0.007/-0.000	0.825	8.505	+0.005/-0.000	5065BD50008500R1N750
9.000	+0.000/-0.003	10.000	+0.007/-0.000	0.825	9.005	+0.005/-0.000	5065BD50009000R1N750
9.500	+0.000/-0.003	10.500	+0.007/-0.000	0.825	9.505	+0.005/-0.000	5065BD50009500R1N750
10.000	+0.000/-0.003	11.000	+0.007/-0.000	0.825	10.005	+0.005/-0.000	5065BD50010000R1N750

*If used with wear rings, refer to wear ring throat diameter, see [Section 9](#). For custom groove calculations, see [Appendix C](#).

Above table reflects recommended cross-sections for rod diameters shown. Alternate cross-sections and additional sizes may be considered. Consult www.parker.com/eps/FluidPower for additional cross-sections and sizes, hardware specifications, and part number availability. Contact your Parker representative for assistance.

Rod Seal BT Profile

◆ Preferred Profile

BT Profile, Premium U-cup Rod Seal with Secondary Stabilizing Lip



The BT profile is a non-symmetrical design for use in hydraulic rod sealing applications. Using Finite Element Analysis, the BT profile was designed to provide improved sealing performance and stability in the gland. A knife trimming process is used to form the beveled lip which is best for removing fluid from the rod. By design, the BT profile has a more robust primary sealing lip than the BS profile and the stabilizing lip is located at the base of the heel. The standard compound for the BT profile is Parker's proprietary Resilon® polyurethane compound. The BT profile provides long life, extrusion resistance, low compression set, shock load resistance and increased sealing performance at zero pressure. The BT profile is designed for use as a stand alone rod seal or for use with the BR or OD profile buffer seals for more critical sealing applications.

Technical Data

Standard Materials	Temperature Range	Pressure Range†	Surface Speed
P4300A90	-65°F to +275°F (-54°C to +135°C)	5000 psi (344 bar)	< 1.6 ft/s (0.5 m/s)

Alternate Materials: For applications that may require an alternate material, please go to www.parker.com/eps/FluidPower to check current tooling and part number availability, or contact your local Parker representative.

†**Pressure Range** without wear rings. If used with wear rings, see [Table 2-4, page 2-5](#).



BT Cross-Section

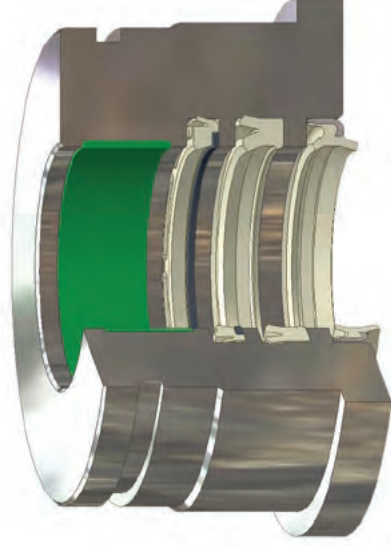

BT Installed in Rod Gland

Part Number Nomenclature – BT Profile

Table 5-8. BT Profile

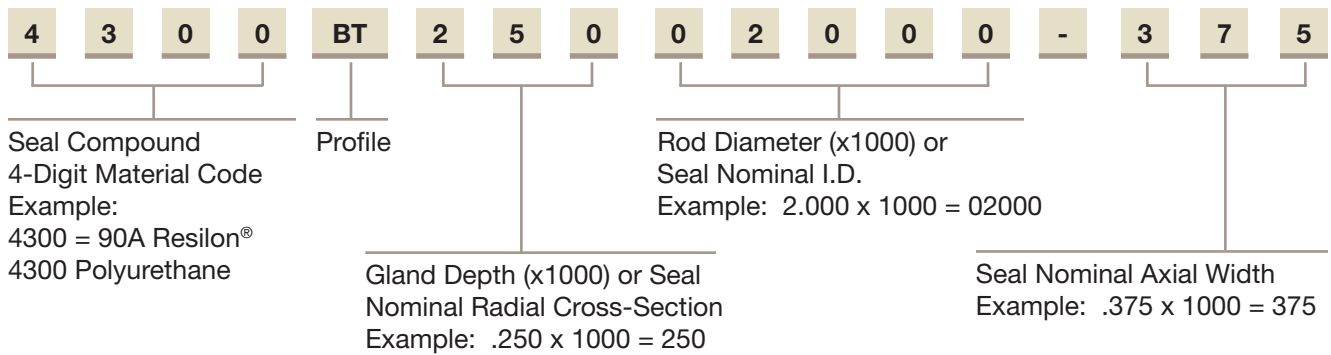

Gland Dimensions – BT Profile

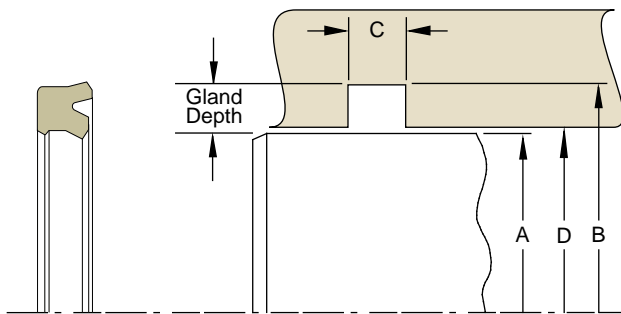

Please refer to [Engineering Section 2, page 2-8](#) for surface finish and additional hardware considerations.

Table 5-9. BT Profile – Rod Gland Calculation

A Rod Diameter		Seal		B Groove Diameter		C Groove Width	D Throat Diameter*	
Range	Tol.	Cross Section	Axial Width	Calculation	Tol.	+015/ -.000	Calculation	Tol.
0.250 - 0.624	+0.000/-0.001	1/8 (.125)	3/16 (.187)	Dia. A + .250	+0.002/-0.000	0.206	Dia. A + .002	+0.002/-0.000
0.625 - 0.999	+0.000/-0.001	1/8 (.125)	1/4 (.250)	Dia. A + .250	+0.002/-0.000	0.275	Dia. A + .002	+0.002/-0.000
1.000 - 1.499	+0.000/-0.002	3/16 (.187)	5/16 (.312)	Dia. A + .375	+0.002/-0.000	0.343	Dia. A + .002	+0.002/-0.000
1.500 - 1.999	+0.000/-0.002	3/16 (.187)	3/8 (.375)	Dia. A + .375	+0.002/-0.000	0.413	Dia. A + .002	+0.002/-0.000
2.000 - 3.499	+0.000/-0.002	1/4 (.250)	3/8 (.375)	Dia. A + .500	+0.003/-0.000	0.413	Dia. A + .003	+0.003/-0.000
3.500 - 4.999	+0.000/-0.002	5/16 (.312)	1/2 (.500)	Dia. A + .625	+0.004/-0.000	0.550	Dia. A + .003	+0.003/-0.000
5.000 - 9.499	+0.000/-0.002	3/8 (.375)	5/8 (.625)	Dia. A + .750	+0.005/-0.000	0.688	Dia. A + .004	+0.004/-0.000
9.500 - 10.000	+0.000/-0.003	1/2 (.500)	3/4 (.750)	Dia. A + 1.000	+0.007/-0.000	0.825	Dia. A + .005	+0.005/-0.000

*If used with wear rings, refer to wear ring throat diameter, see [Section 9](#). For custom groove calculations, see [Appendix C](#).

Above table reflects recommended cross-sections for rod diameters shown. Alternate cross-sections and additional sizes may be considered. Consult www.parker.com/eps/FluidPower for hardware specifications, additional cross-sections and sizes, and part number availability. Contact your Parker representative for assistance.

Gland Dimensions — BT Profile
Table 5-10. BT Profile — Rod Gland Dimensions, ↑Parker Standard Sizes

Hardware Dimensions										Part Number
A Rod Diameter		B Groove Diameter		C Groove Width		D Throat Diameter*				
Dia.	Tol.	Dia.	Tol.	Dia.	Tol.	Dia.	Tol.	Dia.	Tol.	
0.250	+0.00/-0.01	0.500	+0.02/-0.00	0.206	+0.02/-0.00	0.252	+0.02/-0.00	4300BT12500250-187		
0.312	+0.00/-0.01	0.562	+0.02/-0.00	0.206	+0.02/-0.00	0.314	+0.02/-0.00	4300BT12500312-187		
0.375	+0.00/-0.01	0.625	+0.02/-0.00	0.206	+0.02/-0.00	0.377	+0.02/-0.00	4300BT12500375-187		
0.437	+0.00/-0.01	0.687	+0.02/-0.00	0.206	+0.02/-0.00	0.439	+0.02/-0.00	4300BT12500437-187		
0.500	+0.00/-0.01	0.750	+0.02/-0.00	0.206	+0.02/-0.00	0.502	+0.02/-0.00	4300BT12500500-187		
0.625	+0.00/-0.01	0.875	+0.02/-0.00	0.275	+0.02/-0.00	0.627	+0.02/-0.00	4300BT12500625-250		
0.750	+0.00/-0.01	1.000	+0.02/-0.00	0.275	+0.02/-0.00	0.752	+0.02/-0.00	4300BT12500750-250		
0.875	+0.00/-0.01	1.125	+0.02/-0.00	0.275	+0.02/-0.00	0.877	+0.02/-0.00	4300BT12500875-250		
1.000	+0.00/-0.02	1.375	+0.02/-0.00	0.343	+0.02/-0.00	1.002	+0.02/-0.00	4300BT18701000-312		
1.125	+0.00/-0.02	1.500	+0.02/-0.00	0.343	+0.02/-0.00	1.127	+0.02/-0.00	4300BT18701125-312		
1.250	+0.00/-0.02	1.625	+0.02/-0.00	0.343	+0.02/-0.00	1.252	+0.02/-0.00	4300BT18701250-312		
1.375	+0.00/-0.02	1.750	+0.02/-0.00	0.343	+0.02/-0.00	1.377	+0.02/-0.00	4300BT18701375-312		
1.500	+0.00/-0.02	1.875	+0.02/-0.00	0.413	+0.02/-0.00	1.502	+0.02/-0.00	4300BT18701500-375		
1.625	+0.00/-0.02	2.000	+0.02/-0.00	0.413	+0.02/-0.00	1.627	+0.02/-0.00	4300BT18701625-375		
1.750	+0.00/-0.02	2.125	+0.02/-0.00	0.413	+0.02/-0.00	1.752	+0.02/-0.00	4300BT18701750-375		
1.875	+0.00/-0.02	2.250	+0.02/-0.00	0.413	+0.02/-0.00	1.877	+0.02/-0.00	4300BT18701875-375		
2.000	+0.00/-0.02	2.500	+0.03/-0.00	0.413	+0.03/-0.00	2.003	+0.03/-0.00	4300BT25002000-375		
2.125	+0.00/-0.02	2.625	+0.03/-0.00	0.413	+0.03/-0.00	2.128	+0.03/-0.00	4300BT25002125-375		
2.250	+0.00/-0.02	2.750	+0.03/-0.00	0.413	+0.03/-0.00	2.253	+0.03/-0.00	4300BT25002250-375		
2.375	+0.00/-0.02	2.875	+0.03/-0.00	0.413	+0.03/-0.00	2.378	+0.03/-0.00	4300BT25002375-375		
2.500	+0.00/-0.02	3.000	+0.03/-0.00	0.413	+0.03/-0.00	2.503	+0.03/-0.00	4300BT25002500-375		
2.625	+0.00/-0.02	3.125	+0.03/-0.00	0.413	+0.03/-0.00	2.628	+0.03/-0.00	4300BT25002625-375		
2.750	+0.00/-0.02	3.250	+0.03/-0.00	0.413	+0.03/-0.00	2.753	+0.03/-0.00	4300BT25002750-375		
3.000	+0.00/-0.02	3.500	+0.03/-0.00	0.413	+0.03/-0.00	3.003	+0.03/-0.00	4300BT25003000-375		
3.250	+0.00/-0.02	3.750	+0.03/-0.00	0.413	+0.03/-0.00	3.253	+0.03/-0.00	4300BT25003250-375		
3.500	+0.00/-0.02	4.125	+0.04/-0.00	0.550	+0.03/-0.00	3.503	+0.03/-0.00	4300BT31203500-500		
3.750	+0.00/-0.02	4.375	+0.04/-0.00	0.550	+0.04/-0.00	3.753	+0.03/-0.00	4300BT31203750-500		
4.000	+0.00/-0.02	4.625	+0.04/-0.00	0.550	+0.04/-0.00	4.003	+0.03/-0.00	4300BT31204000-500		
4.250	+0.00/-0.02	4.875	+0.04/-0.00	0.550	+0.04/-0.00	4.253	+0.03/-0.00	4300BT31204250-500		
4.500	+0.00/-0.02	5.125	+0.04/-0.00	0.550	+0.04/-0.00	4.503	+0.03/-0.00	4300BT31204500-500		
4.750	+0.00/-0.02	5.375	+0.04/-0.00	0.550	+0.04/-0.00	4.753	+0.03/-0.00	4300BT31204750-500		
5.000	+0.00/-0.02	5.750	+0.05/-0.00	0.688	+0.04/-0.00	5.004	+0.04/-0.00	4300BT37505000-625		
5.500	+0.00/-0.02	6.250	+0.05/-0.00	0.688	+0.04/-0.00	5.504	+0.04/-0.00	4300BT37505500-625		
6.000	+0.00/-0.02	6.750	+0.05/-0.00	0.688	+0.04/-0.00	6.004	+0.04/-0.00	4300BT37506000-625		
6.500	+0.00/-0.02	7.250	+0.05/-0.00	0.688	+0.04/-0.00	6.504	+0.04/-0.00	4300BT37506500-625		
7.000	+0.00/-0.02	7.750	+0.05/-0.00	0.688	+0.04/-0.00	7.004	+0.04/-0.00	4300BT37507000-625		

*If used with wear rings, refer to wear ring throat diameter, see [Section 9](#). For custom groove calculations, see [Appendix C](#).

Above table reflects recommended cross-sections for rod diameters shown. Alternate cross-sections and additional sizes may be considered. Consult www.parker.com/eps/FluidPower for hardware specifications, additional cross-sections and sizes, and part number availability. Contact your Parker representative for assistance.



Gland Dimensions – BT Profile

Table 5-10. BT Profile – Rod Gland Dimensions, ♦Parker Standard Sizes (cont'd)

Hardware Dimensions							Part Number
A Rod Diameter		B Groove Diameter		C Groove Width	D Throat Diameter*		
Dia.	Tol.	Dia.	Tol.	+0.015/-0.000	Dia.	Tol.	
7.500	+0.000/-0.003	8.500	+0.007/-0.000	0.825	7.505	+0.005/-0.000	4300BT50007500-750
8.000	+0.000/-0.003	9.000	+0.007/-0.000	0.825	8.005	+0.005/-0.000	4300BT50008000-750
8.500	+0.000/-0.003	9.500	+0.007/-0.000	0.825	8.505	+0.005/-0.000	4300BT50008500-750
9.000	+0.000/-0.003	10.000	+0.007/-0.000	0.825	9.005	+0.005/-0.000	4300BT50009000-750
9.500	+0.000/-0.003	10.500	+0.007/-0.000	0.825	9.505	+0.005/-0.000	4300BT50009500-750
10.000	+0.000/-0.003	11.000	+0.007/-0.000	0.825	10.005	+0.005/-0.000	4300BT50010000-750

*If used with wear rings, refer to wear ring throat diameter, see [Section 9](#). For custom groove calculations, see [Appendix C](#).

Above table reflects recommended cross-sections for rod diameters shown. Alternate cross-sections and additional sizes may be considered. Consult www.parker.com/eps/FluidPower for hardware specifications, additional cross-sections and sizes, and part number availability. Contact your Parker representative for assistance.

Rod Seal BR Profile

◆ Preferred Profile

Catalog EPS 5370/USA



BR Profile, Premium Buffer Seal

The BR profile is a compact rod seal designed to act as a buffer seal for the primary rod seal. As a buffer seal, the BR profile provides the majority of the rod sealing performance while allowing fluid to bypass and energize the primary rod seal. Fluid located between the BR profile and the rod seal will relieve back into the cylinder by flowing past the BR profile's flexible static side lip and slotted pedestals. This relieving, or check valve function, allows the BR profile and primary rod seal to work as a sealing system without danger of developing a pressure trap. As a sealing system, the BR profile and primary rod seal provide optimal performance in the most difficult applications.

Technical Data

Standard Materials	Temperature Range	Pressure Range*	Surface Speed
P4300A90	-65°F to +275°F (-54°C to +135°C)	5000 psi (344 bar)	< 1.6 ft/s (0.5 m/s)
Back-up W4655NHH	-65°F to +250°F (-54°C to +93°C)	10,000 psi (688 bar)	< 1.6 ft/s (0.5 m/s)

Alternate Materials: For applications that may require an alternate material, please go to www.parker.com/eps/FluidPower to check current tooling and part number availability, or contact your local Parker representative.

***Pressure Range** with positively-activated back-up to 5000 psi (344 bar) when used with tight tolerance wear rings (see [Table 2-4, page 2-5](#)).



**BR Cross-Section
with Back-up**

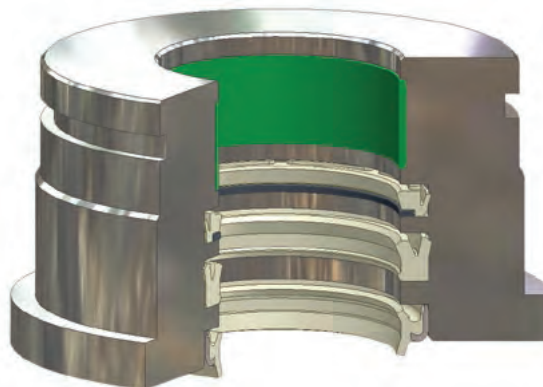

BR Installed in Rod Gland

5

Part Number Nomenclature – BR Profile

Table 5-11. BR Profile

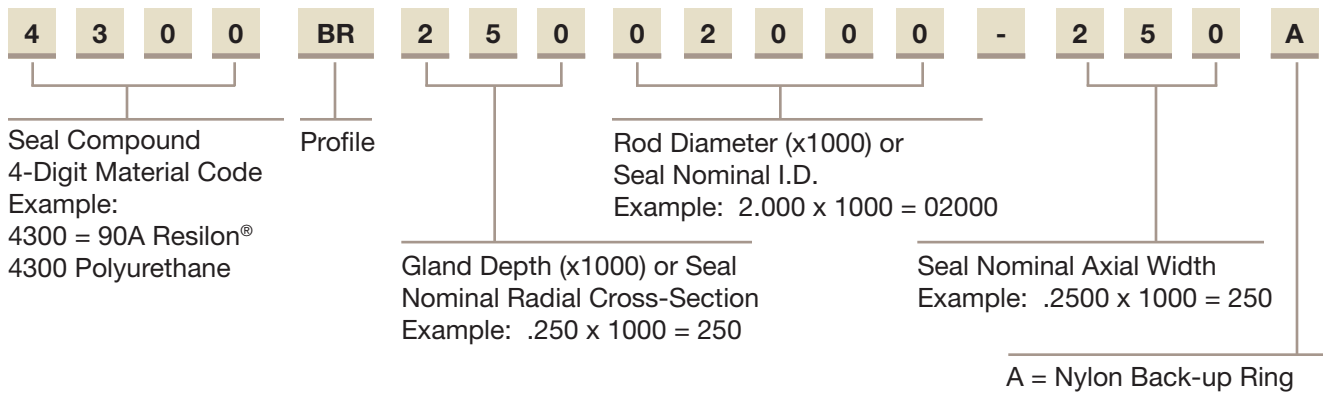

Gland Dimensions – BR Profile

5

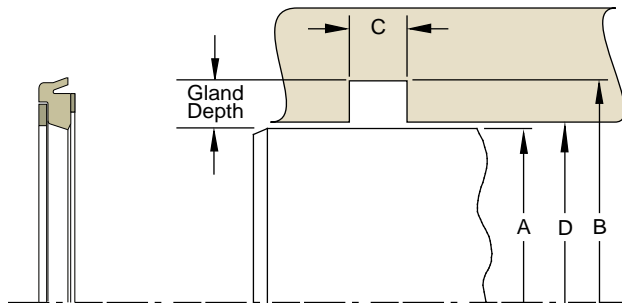

Please refer to [Engineering Section 2, page 2-8](#) for surface finish and additional hardware considerations.

Table 5-12. BR Profile – Rod Gland Calculation

A Rod Diameter		Seal		B Groove Diameter		C Groove Width	D Throat Diameter*	
Range	Tol.	Cross Section	Axial Width	Calculation	Tol.	+0.015/-0.000	Calculation	Tol.
0.250 - 0.999	+0.000/-0.001	1/8 (.125)	3/16 (.187)	Dia. A + .250	+0.002/-0.000	0.138	Dia. A + .002	+0.002/-0.000
1.000 - 1.999	+0.000/-0.002	3/16 (.187)	3/16 (.187)	Dia. A + .375	+0.002/-0.000	0.206	Dia. A + .002	+0.002/-0.000
2.000 - 3.499	+0.000/-0.002	1/4 (.250)	1/4 (.250)	Dia. A + .500	+0.003/-0.000	0.275	Dia. A + .003	+0.003/-0.000
3.500 - 4.999	+0.000/-0.002	5/16 (.312)	5/16 (.312)	Dia. A + .625	+0.004/-0.000	0.343	Dia. A + .003	+0.003/-0.000
5.000 - 9.999	+0.000/-0.002	3/8 (.375)	3/8 (.375)	Dia. A + .750	+0.005/-0.000	0.413	Dia. A + .004	+0.004/-0.000
10.000	+0.000/-0.003	1/2 (.500)	1/2 (.500)	Dia. A + 1.000	+0.007/-0.000	0.550	Dia. A + .005	+0.005/-0.000

*If used with wear rings, refer to wear ring throat diameter, see [Section 9](#). For custom groove calculations, see [Appendix C](#).

Above table reflects recommended cross-sections for rod diameters shown. Alternate cross-sections and additional sizes may be considered. Consult www.parker.com/eps/FluidPower for hardware specifications, additional cross-sections and sizes, and part number availability. Contact your Parker representative for assistance.

Gland Dimensions – BR Profile
Table 5-13. BR Profile – Rod Gland Dimensions, ♦Parker Standard Sizes

Hardware Dimensions							Part Number
A Rod Diameter		B Groove Diameter		C Groove Width	D Throat Diameter*		
Dia	Tol	Dia	Tol	+0.015/-0.000	Dia	Tol	
0.250	+0.000/-0.001	0.500	+0.002/-0.000	0.138	0.252	+0.002/-0.000	4300BR12500250-125A
0.312	+0.000/-0.001	0.562	+0.002/-0.000	0.138	0.314	+0.002/-0.000	4300BR125000312-125A
0.375	+0.000/-0.001	0.625	+0.002/-0.000	0.138	0.377	+0.002/-0.000	4300BR125000375-125A
0.437	+0.000/-0.001	0.687	+0.002/-0.000	0.138	0.439	+0.002/-0.000	4300BR125000437-125A
0.500	+0.000/-0.001	0.750	+0.002/-0.000	0.138	0.502	+0.002/-0.000	4300BR125000500-125A
0.625	+0.000/-0.001	0.875	+0.002/-0.000	0.138	0.627	+0.002/-0.000	4300BR12500625-125A
0.750	+0.000/-0.001	1.000	+0.002/-0.000	0.138	0.752	+0.002/-0.000	4300BR12500750-125A
0.875	+0.000/-0.001	1.125	+0.002/-0.000	0.138	0.877	+0.002/-0.000	4300BR12500875-125A
1.000	+0.000/-0.002	1.375	+0.002/-0.000	0.206	1.002	+0.002/-0.000	4300BR18701000-187A
1.125	+0.000/-0.002	1.500	+0.002/-0.000	0.206	1.127	+0.002/-0.000	4300BR18701125-187A
1.250	+0.000/-0.002	1.625	+0.002/-0.000	0.206	1.252	+0.002/-0.000	4300BR18701250-187A
1.375	+0.000/-0.002	1.750	+0.002/-0.000	0.206	1.377	+0.002/-0.000	4300BR18701375-187A
1.500	+0.000/-0.002	1.875	+0.002/-0.000	0.206	1.502	+0.002/-0.000	4300BR18701500-187A
1.625	+0.000/-0.002	2.000	+0.002/-0.000	0.206	1.627	+0.002/-0.000	4300BR18701625-187A
1.750	+0.000/-0.002	2.125	+0.002/-0.000	0.206	1.752	+0.002/-0.000	4300BR18701750-187A
1.875	+0.000/-0.002	2.250	+0.002/-0.000	0.206	1.877	+0.002/-0.000	4300BR18701875-187A
2.000	+0.000/-0.002	2.500	+0.003/-0.000	0.275	2.003	+0.003/-0.000	4300BR25002000-250A
2.125	+0.000/-0.002	2.625	+0.003/-0.000	0.275	2.128	+0.003/-0.000	4300BR25002125-250A
2.250	+0.000/-0.002	2.750	+0.003/-0.000	0.275	2.253	+0.003/-0.000	4300BR25002250-250A
2.375	+0.000/-0.002	2.875	+0.003/-0.000	0.275	2.378	+0.003/-0.000	4300BR25002375-250A
2.500	+0.000/-0.002	3.000	+0.003/-0.000	0.275	2.503	+0.003/-0.000	4300BR25002500-250A
2.625	+0.000/-0.002	3.125	+0.003/-0.000	0.275	2.628	+0.003/-0.000	4300BR25002625-250A
2.750	+0.000/-0.002	3.250	+0.003/-0.000	0.275	2.753	+0.003/-0.000	4300BR25002750-250A
3.000	+0.000/-0.002	3.500	+0.003/-0.000	0.275	3.003	+0.003/-0.000	4300BR25003000-250A
3.250	+0.000/-0.002	3.750	+0.003/-0.000	0.275	3.253	+0.003/-0.000	4300BR25003250-250A
3.500	+0.000/-0.002	4.125	+0.004/-0.000	0.343	3.503	+0.003/-0.000	4300BR31203500-312A
3.750	+0.000/-0.002	4.375	+0.004/-0.000	0.343	3.753	+0.003/-0.000	4300BR31203750-312A
4.000	+0.000/-0.002	4.625	+0.004/-0.000	0.343	4.003	+0.003/-0.000	4300BR31204000-312A
4.250	+0.000/-0.002	4.875	+0.004/-0.000	0.343	4.253	+0.003/-0.000	4300BR31204250-312A
4.500	+0.000/-0.002	5.125	+0.004/-0.000	0.343	4.503	+0.003/-0.000	4300BR31204500-312A
4.750	+0.000/-0.002	5.375	+0.004/-0.000	0.343	4.753	+0.003/-0.000	4300BR31204750-312A
5.000	+0.000/-0.002	5.750	+0.005/-0.000	0.413	5.004	+0.004/-0.000	4300BR37505000-375A
5.500	+0.000/-0.002	6.250	+0.005/-0.000	0.413	5.504	+0.004/-0.000	4300BR37505500-375A
6.000	+0.000/-0.002	6.750	+0.005/-0.000	0.413	6.004	+0.004/-0.000	4300BR37506000-375A
6.500	+0.000/-0.002	7.250	+0.005/-0.000	0.413	6.504	+0.004/-0.000	4300BR37506500-375A
7.000	+0.000/-0.002	7.750	+0.005/-0.000	0.413	7.004	+0.004/-0.000	4300BR37507000-375A

*If used with wear rings, refer to wear ring throat diameter, see [Section 9](#). For custom groove calculations, see [Appendix C](#).

Above table reflects recommended cross-sections for rod diameters shown. Alternate cross-sections and additional sizes may be considered. Consult www.parker.com/eps/FluidPower for hardware specifications, additional cross-sections and sizes, and part number availability. Contact your Parker representative for assistance.



Gland Dimensions – BR Profile

Table 5-13. BR Profile – Rod Gland Dimensions, ♦Parker Standard Sizes (cont'd)

Hardware Dimensions							Part Number
A Rod Diameter		B Groove Diameter		C Groove Width	D Throat Diameter*		
Dia	Tol	Dia	Tol	+0.015/-0.000	Dia	Tol	
7.500	+0.000/-0.003	8.500	+0.007/-0.000	0.550	7.505	+0.005/-0.000	4300BR50007500-500A
8.000	+0.000/-0.003	9.000	+0.007/-0.000	0.550	8.005	+0.005/-0.000	4300BR50008000-500A
8.500	+0.000/-0.003	9.500	+0.007/-0.000	0.550	8.505	+0.005/-0.000	4300BR50008500-500A
9.000	+0.000/-0.003	10.000	+0.007/-0.000	0.550	9.005	+0.005/-0.000	4300BR50009000-500A
9.500	+0.000/-0.003	10.500	+0.007/-0.000	0.550	9.505	+0.005/-0.000	4300BR50009500-500A
10.000	+0.000/-0.003	11.000	+0.007/-0.000	0.550	10.005	+0.005/-0.000	4300BR50010000-500A

*If used with wear rings, refer to wear ring throat diameter, see [Section 9](#). For custom groove calculations, see [Appendix C](#).

Above table reflects recommended cross-sections for rod diameters shown. Alternate cross-sections and additional sizes may be considered. Consult www.parker.com/eps/FluidPower for hardware specifications, additional cross-sections and sizes, and part number availability. Contact your Parker representative for assistance.

5

Table 5-14. BR Profile – Rod Gland Dimensions, ♦Parker Standard Sizes

Resilon® 4300 BR Profile Designed to Retrofit Typical PTFE Buffer Seal Grooves.

Hardware Dimensions							Part Number
A Rod Diameter		B Groove Diameter		C Groove Width	D Throat Diameter*		
Dia	Tol	Dia	Tol	+0.010/-0.000	Dia	Tol	
2.750	+0.000/-0.004	3.366	+0.005/-0.000	0.247	2.753	+0.003/-0.000	4300BR30802750-227A
3.000	+0.000/-0.004	3.616	+0.005/-0.000	0.247	3.003	+0.003/-0.000	4300BR30803000-227A
3.250	+0.000/-0.004	3.866	+0.005/-0.000	0.247	3.253	+0.003/-0.000	4300BR30803250-227A
3.500	+0.000/-0.004	4.116	+0.005/-0.000	0.247	3.503	+0.003/-0.000	4300BR30803500-227A
3.750	+0.000/-0.004	4.366	+0.005/-0.000	0.247	3.753	+0.003/-0.000	4300BR30803750-227A
4.000	+0.000/-0.004	4.616	+0.005/-0.000	0.247	4.003	+0.003/-0.000	4300BR30804000-227A

*If used with wear rings, refer to wear ring throat diameter, see [Section 9](#). For custom groove calculations, see [Appendix C](#).

Above table reflects recommended cross-sections for rod diameters shown. Alternate cross-sections and additional sizes may be considered. Consult www.parker.com/eps/FluidPower for hardware specifications, additional cross-sections and sizes, and part number availability. Contact your Parker representative for assistance.

Rod Seal

B3 Profile

Catalog EPS 5370/USA

B3 Profile, U-cup Rod Seal

The B3 profile is a non-symmetrical design for use in hydraulic rod sealing applications. The diameter of the B3 profile is designed to ensure a tight static side seal when installed. The knife trimmed, beveled lip does an excellent job wiping fluid film. The B3 profile is available in Parker proprietary compounds offering extrusion resistance, long wear, and low compression set. The B3 profile is designed for use as a stand alone rod seal and can be used with Parker's BR or OD profile buffer seals for more critical sealing applications.

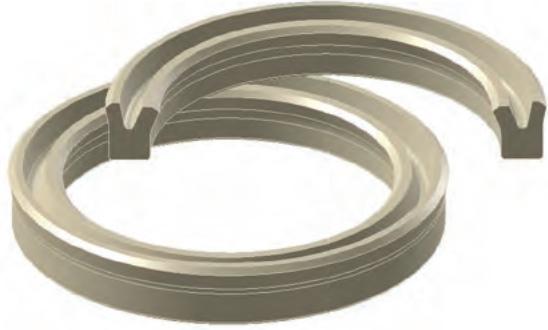

Technical Data

Standard Materials	Temperature Range	Pressure Range†	Surface Speed
P4300A90	-65°F to +275°F (-54°C to +135°C)	5000 psi (344 bar)	< 1.6 ft/s (0.5 m/s)
P4301A90	-65°F to +275°F (-54°C to +135°C)	5000 psi (344 bar)	< 1.6 ft/s (0.5 m/s)
P4700A90	-65°F to +200°F (-54°C to +93°C)	5000 psi (344 bar)	< 1.6 ft/s (0.5 m/s)
P5065A88	-70°F to +200°F (-57°C to +93°C)	3,500 psi (241 bar)	< 1.6 ft/s (0.5 m/s)

Alternate Materials: For applications that may require an alternate material, please go to www.parker.com/eps/FluidPower to check current tooling and part number availability, or contact your local Parker representative.

†**Pressure Range** without wear rings. If used with wear rings, see [Table 2-4, page 2-5](#).



B3 Cross-Section

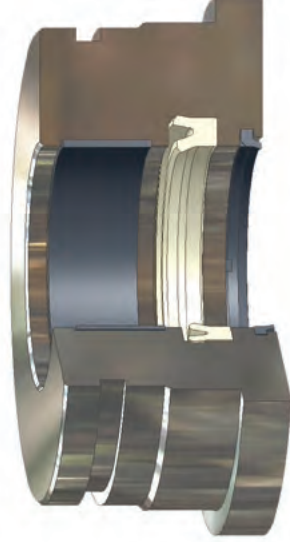

B3 Installed in Rod Gland

Part Number Nomenclature – B3 Profile

Table 5-15. B3 Profile

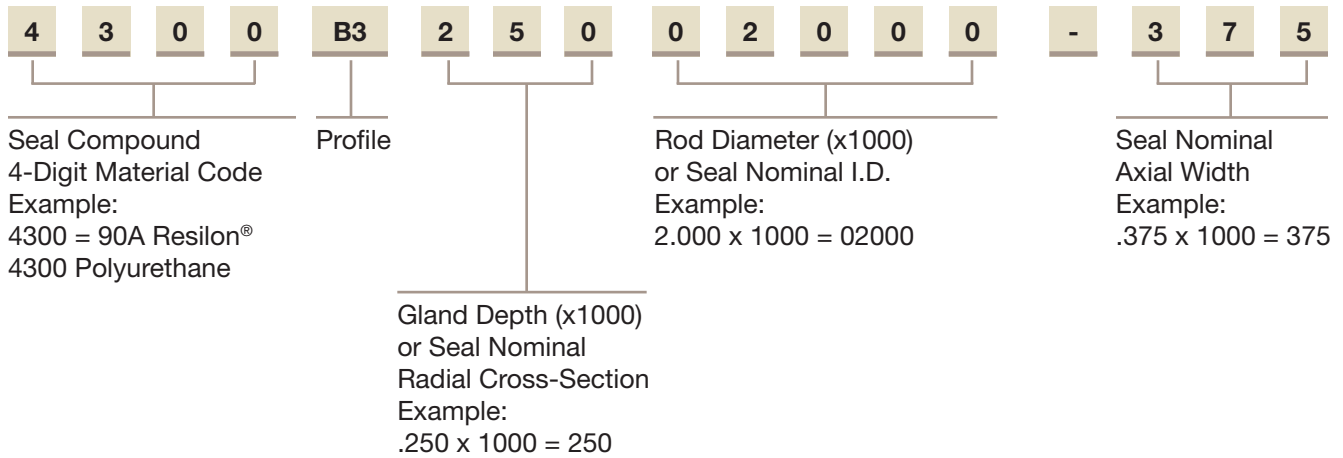

5

Gland Dimensions – B3 Profile

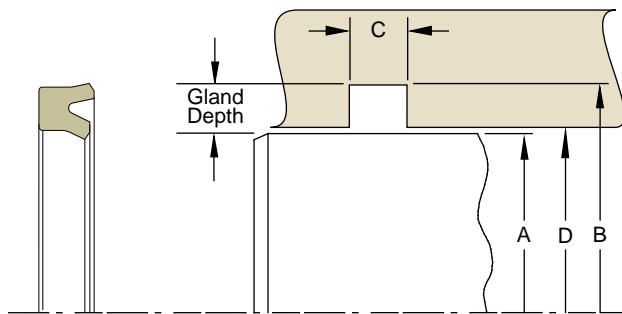

Please refer to [Engineering Section 2, page 2-8](#) for surface finish and additional hardware considerations.

Table 5-16. B3 Profile – Rod Gland Calculation

A Rod Diameter		Seal		B Groove Diameter		C Groove Width	D Throat Diameter*	
Range	Tol.	Cross Section	Axial Width	Calculation	Tol.	+ .015/- .000	Calculation	Tol.
0.250 - 0.624	+ .000/- .001	1/8 (.125)	3/16 (.187)	Dia. A + .250	+ .002/- .000	0.206	Dia. A + .002	+ .002/- .000
0.625 - 0.999	+ .000/- .001	1/8 (.125)	1/4 (.250)	Dia. A + .250	+ .002/- .000	0.275	Dia. A + .002	+ .002/- .000
1.000 - 1.499	+ .000/- .002	3/16 (.187)	5/16 (.312)	Dia. A + .375	+ .002/- .000	0.343	Dia. A + .002	+ .002/- .000
1.500 - 1.999	+ .000/- .002	3/16 (.187)	3/8 (.375)	Dia. A + .375	+ .002/- .000	0.413	Dia. A + .002	+ .002/- .000
2.000 - 3.499	+ .000/- .002	1/4 (.250)	3/8 (.375)	Dia. A + .500	+ .003/- .000	0.413	Dia. A + .003	+ .003/- .000
3.500 - 4.999	+ .000/- .002	5/16 (.312)	1/2 (.500)	Dia. A + .625	+ .004/- .000	0.550	Dia. A + .003	+ .003/- .000
5.000 - 9.499	+ .000/- .002	3/8 (.375)	5/8 (.625)	Dia. A + .750	+ .005/- .000	0.688	Dia. A + .004	+ .004/- .000
9.500 - 10.000	+ .000/- .003	1/2 (.500)	3/4 (.750)	Dia. A + 1.000	+ .007/- .000	0.825	Dia. A + .005	+ .005/- .000

*If used with wear rings, refer to wear ring throat diameter, see [Section 9](#). For custom groove calculations, see [Appendix C](#).

Above table reflects recommended cross-sections for rod diameters shown. Alternate cross-sections and additional sizes may be considered. Consult www.parker.com/eps/FluidPower for hardware specifications, additional cross-sections and sizes, and part number availability. Contact your Parker representative for assistance.

Rod Seal

BS Profile

Catalog EPS 5370/USA

BS Profile, U-cup Rod Seal with Secondary Stabilizing Lip



The BS profile is a non-symmetrical profile designed for use in hydraulic rod sealing applications. The knife trimmed beveled sealing lip does an excellent job wiping fluid from the rod. In addition, a secondary stabilizing lip is located just above the base of the seal to provide enhanced sealing performance and ensure a tight, stable fit in the gland. Available in Parker proprietary urethanes, the BS profile provides long life, extrusion resistance, low compression set, shock load resistance and increased sealing performance at zero pressure. The BS profile is designed to be used as a stand alone rod seal or for use with the BR or OD profile buffer seals for more critical sealing applications.

Technical Data

Standard Materials	Temperature Range	Pressure Range†	Surface Speed
P4300A90	-65°F to +275°F (-54°C to +135°C)	5000 psi (344 bar)	< 1.6 ft/s (0.5 m/s)
P4301A90	-65°F to +275°F (-54°C to +135°C)	5000 psi (344 bar)	< 1.6 ft/s (0.5 m/s)
P4700A90	-65°F to +200°F (-54°C to +93°C)	5000 psi (344 bar)	< 1.6 ft/s (0.5 m/s)
P5065A88	-70°F to +200°F (-57°C to +93°C)	3,500 psi (241 bar)	< 1.6 ft/s (0.5 m/s)



BS Cross-Section

Alternate Materials: For applications that may require an alternate material, please go to www.parker.com/eps/FluidPower to check current tooling and part number availability, or contact your local Parker representative.

†**Pressure Range** without wear rings. If used with wear rings, see [Table 2-4, page 2-5](#).

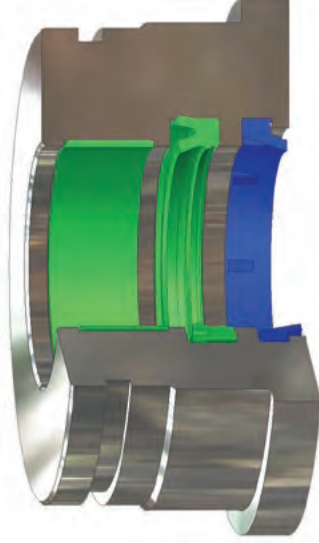

BS Installed in Rod Gland

Part Number Nomenclature – BS Profile

Table 5-17. BS Profile

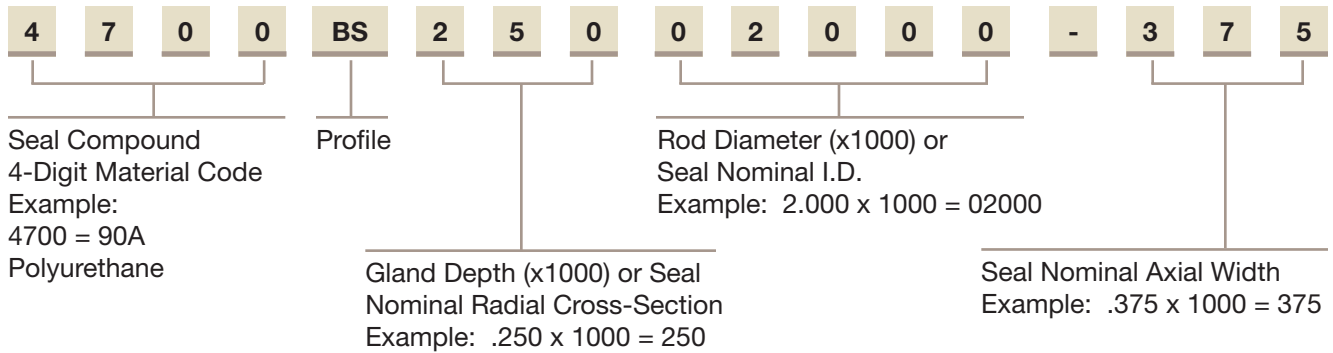

Gland Dimensions – BS Profile

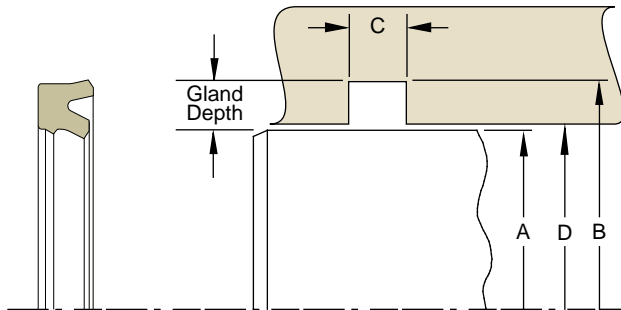

Please refer to [Engineering Section 2, page 2-8](#) for surface finish and additional hardware considerations.

Table 5-18. BS Profile – Rod Gland Calculation

A Rod Diameter		Seal		B Groove Diameter		C Groove Width	D Throat Diameter*	
Range	Tol.	Cross Section	Axial Width	Calculation	Tol.	+0.015/-0.000	Calculation	Tol.
0.250 - 0.624	+0.000/-0.001	1/8 (.125)	3/16 (.187)	Dia. A + .250	+0.002/-0.000	0.206	Dia. A + .002	+0.002/-0.000
0.625 - 0.999	+0.000/-0.001	1/8 (.125)	1/4 (.250)	Dia. A + .250	+0.002/-0.000	0.275	Dia. A + .002	+0.002/-0.000
1.000 - 1.499	+0.000/-0.002	3/16 (.187)	5/16 (.312)	Dia. A + .375	+0.002/-0.000	0.343	Dia. A + .002	+0.002/-0.000
1.500 - 1.999	+0.000/-0.002	3/16 (.187)	3/8 (.375)	Dia. A + .375	+0.002/-0.000	0.413	Dia. A + .002	+0.002/-0.000
2.000 - 3.499	+0.000/-0.002	1/4 (.250)	3/8 (.375)	Dia. A + .500	+0.003/-0.000	0.413	Dia. A + .003	+0.003/-0.000
3.500 - 4.999	+0.000/-0.002	5/16 (.312)	1/2 (.500)	Dia. A + .625	+0.004/-0.000	0.550	Dia. A + .003	+0.003/-0.000
5.000 - 9.499	+0.000/-0.002	3/8 (.375)	5/8 (.625)	Dia. A + .750	+0.005/-0.000	0.688	Dia. A + .004	+0.004/-0.000
9.500 - 10.000	+0.000/-0.003	1/2 (.500)	3/4 (.750)	Dia. A + 1.000	+0.007/-0.000	0.825	Dia. A + .005	+0.005/-0.000

*If used with wear rings, refer to wear ring throat diameter, see [Section 9](#). For custom groove calculations, see [Appendix C](#).

Above table reflects recommended cross-sections for rod diameters shown. Alternate cross-sections and additional sizes may be considered. Consult www.parker.com/eps/FluidPower for hardware specifications, additional cross-sections and sizes, and part number availability. Contact your Parker representative for assistance.

Rod Seal UR Profile

Catalog EPS 5370/USA



UR Profile, Industrial U-cup Rod Seal

The UR profile is a non-symmetrical, hydraulic cylinder rod seal. The knife trimmed, beveled lip faces the rod to provide enhanced low to high pressure sealing and wiping action. The UR profile is an economical choice, available in Parker's wear- and extrusion-resistant Molythane® compound.

Technical Data

Standard Materials	Temperature Range	Pressure Range†	Surface Speed
P4615A90	-65°F to +200°F (-54°C to +93°C)	5000 psi (344 bar)	< 1.6 ft/s (0.5 m/s)

Alternate Materials: For applications that may require an alternate material, please go to www.parker.com/eps/FluidPower to check current tooling and part number availability, or contact your local Parker representative.

†**Pressure Range** without wear rings. If used with wear rings, see [Table 2-4, page 2-5](#).



UR Cross-Section

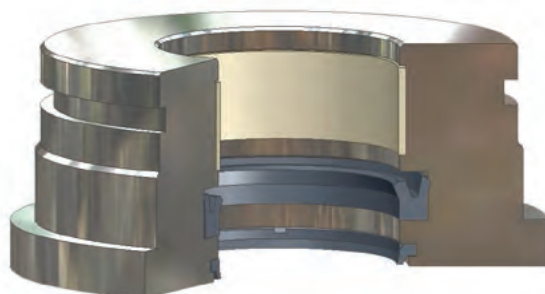

UR Installed in Rod Gland

5

Part Number Nomenclature – UR Profile

Table 5-19. UR Profile

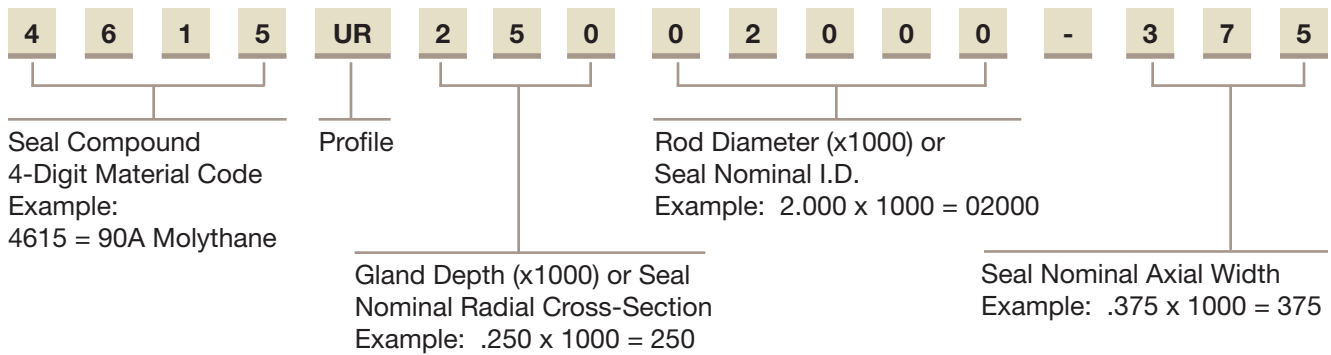

Gland Dimensions – UR Profile

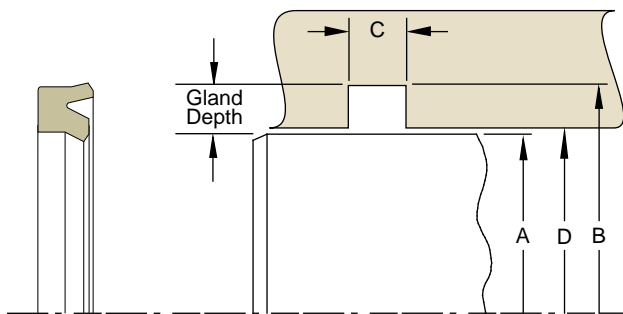

Please refer to [Engineering Section 2, page 2-8](#) for surface finish and additional hardware considerations.

Table 5-20. UR Profile – Rod Gland Calculation

A Rod Diameter		Seal		B Groove Diameter		C Groove Width	D Throat Diameter*	
Range	Tol.	Cross Section	Axial Width	Calculation	Tol.	+0.015/-0.000	Calculation	Tol.
0.250 - 0.624	+0.000/-0.001	1/8 (.125)	3/16 (.187)	Dia. A + .250	+0.002/-0.000	0.206	Dia. A + .002	+0.002/-0.000
0.625 - 0.999	+0.000/-0.001	1/8 (.125)	1/4 (.250)	Dia. A + .250	+0.002/-0.000	0.275	Dia. A + .002	+0.002/-0.000
1.000 - 1.499	+0.000/-0.002	3/16 (.187)	5/16 (.312)	Dia. A + .375	+0.002/-0.000	0.343	Dia. A + .002	+0.002/-0.000
1.500 - 1.999	+0.000/-0.002	3/16 (.187)	3/8 (.375)	Dia. A + .375	+0.002/-0.000	0.413	Dia. A + .002	+0.002/-0.000
2.000 - 3.499	+0.000/-0.002	1/4 (.250)	3/8 (.375)	Dia. A + .500	+0.003/-0.000	0.413	Dia. A + .003	+0.003/-0.000
3.500 - 4.999	+0.000/-0.002	5/16 (.312)	1/2 (.500)	Dia. A + .625	+0.004/-0.000	0.550	Dia. A + .003	+0.003/-0.000
5.000 - 9.499	+0.000/-0.002	3/8 (.375)	5/8 (.625)	Dia. A + .750	+0.005/-0.000	0.688	Dia. A + .004	+0.004/-0.000
9.500 - 10.000	+0.000/-0.003	1/2 (.500)	3/4 (.750)	Dia. A + 1.000	+0.007/-0.000	0.825	Dia. A + .005	+0.005/-0.000

*If used with wear rings, refer to wear ring throat diameter, see [Section 9](#). For custom groove calculations, see [Appendix C](#).

Above table reflects recommended cross-sections for rod diameters shown. Alternate cross-sections and additional sizes may be considered. Consult www.parker.com/eps/FluidPower for hardware specifications, additional cross-sections and sizes, and part number availability. Contact your Parker representative for assistance.

Rod Seal E5 Profile

Catalog EPS 5370/USA

E5 Profile, Rounded Lip Pneumatic U-cup Rod Seal

Parker's E5 profile is a non-symmetrical rod seal designed to seal both lubricated and non-lubricated air. To ensure that critical surfaces retain lubrication, the radius edge of the lip is designed to hydroplane over pre-lubricated surfaces. The standard compound for the E5 profile is Parker's proprietary Nitroxile® extreme low friction ("ELF") compound N4274A85. This compound is formulated with proprietary internal lubricants to provide extreme low friction and excellent wear resistance. This compound provides extended cycle life over standard nitrile and carboxylated nitrile compounds.



Technical Data

Standard Materials	Temperature Range	Pressure Range†	Surface Speed
N4274A85	-10°F to +250°F (-23°C to +121°C)	250 psi (17 bar)	< 3 ft/s (1 m/s)
N4180A80	-40°F to +250°F (-40°C to +121°C)	250 psi (17 bar)	< 3 ft/s (1 m/s)
V4208A90	-5°F to +400°F (-21°C to +204°C)	250 psi (17 bar)	< 3 ft/s (1 m/s)
P5065A88	-70°F to +200°F (-57°C to +93°C)	250 psi (17 bar)	< 3 ft/s (1 m/s)



E5 Cross-Section

Alternate Materials: For applications that may require an alternate material, please go to www.parker.com/eps/FluidPower to check current tooling and part number availability, or contact your local Parker representative.

†**Pressure Range** without wear rings. If used with wear rings, see [Table 2-4, page 2-5](#).

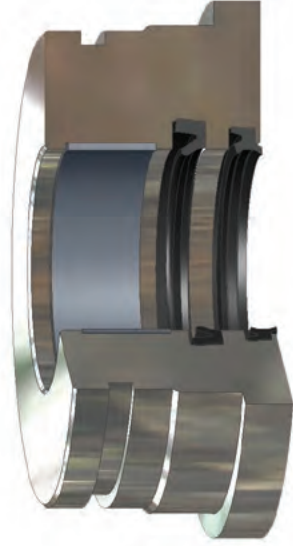

E5 Installed in Rod Gland

Part Number Nomenclature – E5 Profile

Table 5-21. E5 Profile

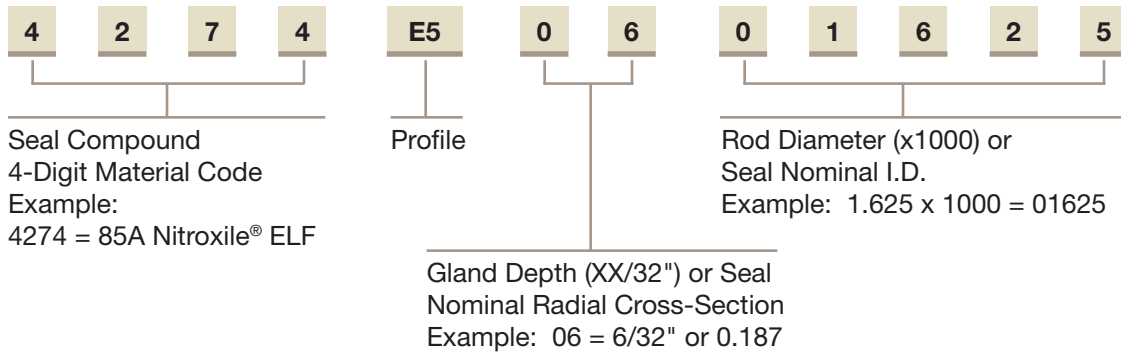

Gland Dimensions – E5 Profile

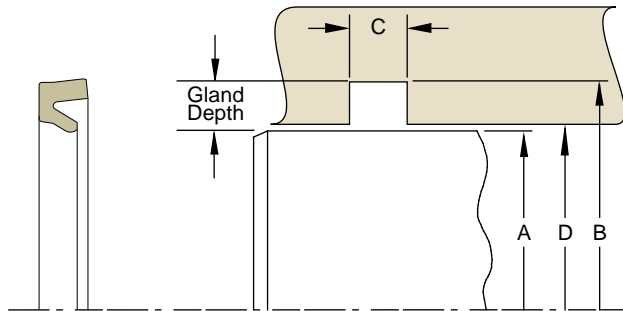

Please refer to [Engineering Section 2, page 2-8](#) for surface finish and additional hardware considerations.

Table 5-22. E5 Profile – Rod Gland Calculation

A Rod Diameter		Seal		B Groove Diameter		C Groove Width	D Throat Diameter*	
Range	Tol.	Cross Section	Axial Width	Calculation	Tol.	+0.015/-0.000	Calculation	Tol.
0.125 - .999	+0.000/-0.001	1/8 (.125)	1/8 (.125)	Dia A + .250	+0.002/-0.000	0.156	Dia A + .001	+0.002/-0.000
1.000 - 1.499	+0.000/-0.001	5/32 (.156)	5/32 (.156)	Dia A + .312	+0.002/-0.000	0.188	Dia A + .001	+0.002/-0.000
1.500 - 2.499	+0.000/-0.002	3/16 (.187)	3/16 (.187)	Dia A + .375	+0.002/-0.000	0.218	Dia A + .002	+0.002/-0.000
2.500 - 3.499	+0.000/-0.002	7/32 (.218)	7/32 (.218)	Dia A + .437	+0.002/-0.000	0.250	Dia A + .002	+0.002/-0.000
3.500 - 4.999	+0.000/-0.002	1/4 (.250)	1/4 (.250)	Dia A + .500	+0.003/-0.000	0.281	Dia A + .003	+0.003/-0.000
5.000 - 7.999	+0.000/-0.002	5/16 (.312)	5/16 (.312)	Dia A + .625	+0.004/-0.000	0.344	Dia A + .003	+0.003/-0.000
8.000 - 10.000	+0.000/-0.002	3/8 (.375)	3/8 (.375)	Dia A + .750	+0.005/-0.000	0.406	Dia A + .004	+0.004/-0.000

*If used with wear rings, refer to wear ring throat diameter, see [Section 9](#). For custom groove calculations, see [Appendix C](#).

Above table reflects recommended cross-sections for rod diameters shown. Alternate cross-sections and additional sizes may be considered. Consult www.parker.com/eps/FluidPower for hardware specifications, additional cross-sections and sizes, and part number availability. Contact your Parker representative for assistance.

Rod Seal TR Profile

Catalog EPS 5370/USA

TR Profile (Rod T-seal) Compact Seal with Anti-Extrusion Technology



Parker's TR profile rod T-seal is designed to retrofit o-rings in no back-up, single back-up and two back-up standard industrial reciprocating o-ring glands. Its compact design provides improved stability and extrusion resistance in dynamic fluid sealing applications. The flange or base of the T-seal forms a tight seal in the gland and supports the anti-extrusion back-up rings. When energized, the back-up rings bridge the extrusion gap to protect the rubber sealing element from extrusion and system contamination. The T-seal eliminates the spiral or twisting failure that can occur when o-rings are used against a dynamic surface. Parker offers the TR profile in a variety of elastomer and back-up ring compounds to cover a wide range of fluid compatibility, pressure and temperature requirements.

Profile **TR0** for no back-up o-ring gland (standard offering)

Profile **TRS** for **single** back-up o-ring gland

Profile **TRT** for **two** back-up o-ring gland

The **TR** profile is sold only as an assembly (elastomer and back-ups).

Technical Data

Standard Materials



TR Cross-Section

Base

Elastomer*	Temperature Range	Surface Speed
N4115A75	-40°F to +225°F (-40°C to +107°C)	< 1.6 ft/s (0.5 m/s)
N4274A85	-10°F to +250°F (-23°C to +121°C)	< 1.6 ft/s (0.5 m/s)
V4205A75	-20°F to +400°F (-29°C to +204°C)	< 1.6 ft/s (0.5 m/s)
E4259A80	-65°F to +300°F (-54°C to +149°C)	< 1.6 ft/s (0.5 m/s)

***Alternate Materials:** For applications that may require an alternate elastomer material, please go to www.parker.com/eps/FluidPower to check current tooling and part number availability, or contact your local Parker representative.



TR Installed in Rod Gland

Technical Data (Continued)

Standard Materials

Back-up Rings**

	Temperature Range
B001 (4655)	-65°F to +275°F (-54°C to +135°C)
B011 (Virgin PTFE)	-425°F to +450°F (-254°C to +233°C)
B085 (PEEK)	-65°F to +500°F (-54°C to +260°C)

Pressure Range†

5,000 psi (344 bar)
3,000 psi (206 bar)
10,000 psi (689 bar)

****Alternate Materials:** For applications that may require an alternate material, please see [Section 3](#) for alternate materials.

†**Pressure Range** without wear rings (see [Table 2-4, page 2-5](#)).

Part Number Nomenclature – TR Profile

Table 5-23. TR Profile

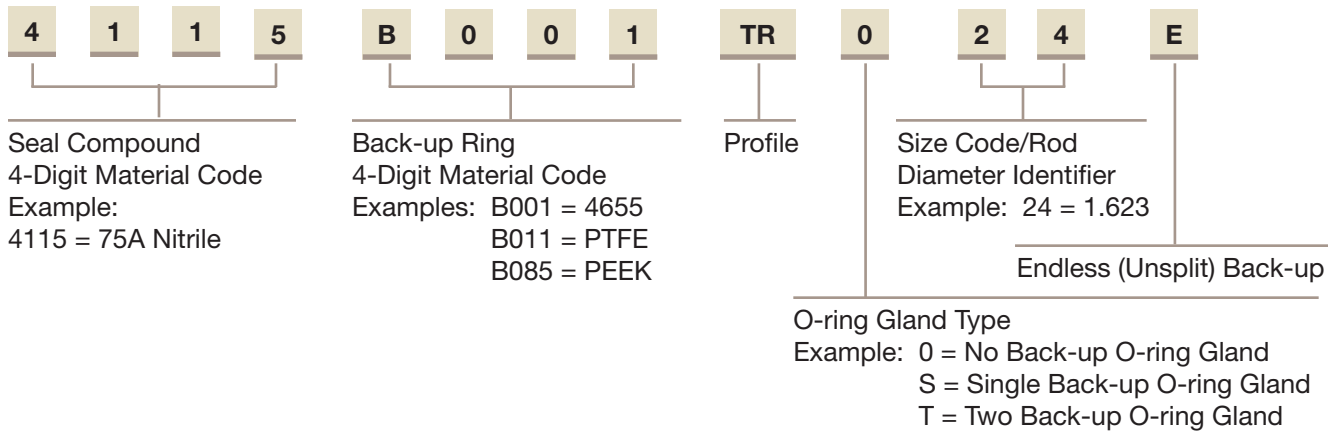

Gland Dimensions – TR Profile

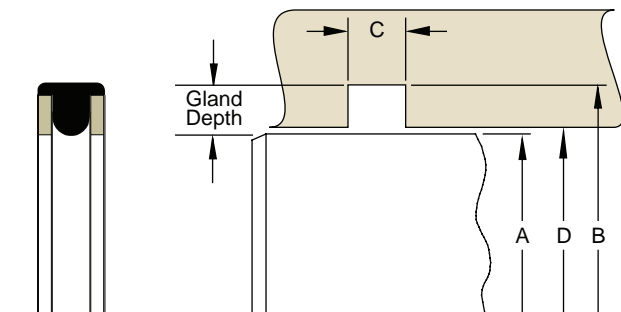

Please refer to [Engineering Section 2, page 2-8](#) for surface finish and additional hardware considerations.

Gland Dimensions — TR Profile

Table 5-24. TR Profile Rod Gland Calculation

A Rod Diameter Range	TR Profile Number	Ref: O-Ring Dash #	B Groove Diameter	C TRO Groove Width	C TRS Groove Width	C TRT Groove Width	D Throat Diameter
+ .000/- .002			+ .002/- .000	+ .005/- .000	+ .005/- .000	+ .005/- .000	+ .001/- .000
0.186 - 0.311	01 to 03	2-106 to 2-109	Dia. A + .176	0.140	0.171	0.238	Dia. A + .002
0.373 - 1.498	04 to 22	2-204 to 2-222	Dia. A + .242	0.187	0.208	0.275	Dia. A + .003
1.498 - 4.498	23 to 47	2-325 to 2-349	Dia. A + .370	0.281	0.311	0.410	Dia. A + .003
4.997 - 11.997	48 to 65	2-429 to 2-453	Dia. A + .474	0.375	0.498	0.538	Dia. A + .004

*If used with wear rings, refer to wear ring throat diameter, see [Section 9](#). For custom groove calculations, see [Appendix C](#).

Above table reflects recommended cross-sections for rod diameters shown. Alternate cross-sections and additional sizes may be considered. Consult www.parker.com/eps/FluidPower for hardware specifications, additional cross-sections and sizes, and part number availability. Contact your Parker representative for assistance.

Gland Dimensions — TR Profile

Table 5-25. TR Profile — O-Ring Dash # Reference

TR Profile Number	Ref: O-Ring Dash #
01	2-106
02	2-108
03	2-109
04	2-204
05	2-205
06	2-206
07	2-207
08	2-208
09	2-209
10	2-210
11	2-211
12	2-212
13	2-213
14	2-214
15	2-215
16	2-216
17	2-217
18	2-218
19	2-219
20	2-220
21	2-221
22	2-222
23	2-325

TR Profile Number	Ref: O-Ring Dash #
24	2-326
25	2-327
26	2-328
27	2-329
28	2-330
29	2-331
30	2-332
31	2-333
32	2-334
33	2-335
34	2-336
35	2-337
36	2-338
37	2-339
38	2-340
39	2-341
40	2-342
41	2-343
42	2-344
43	2-345
44	2-346
45	2-347
46	2-348

TR Profile Number	Ref: O-Ring Dash #
47	2-349
48	2-429
49	2-431
50	2-433
51	2-434
52	2-437
53	2-438
54	2-439
55	2-440
56	2-441
57	2-442
58	2-443
59	2-445
60	2-447
61	2-448
62	2-449
63	2-451
64	2-452
65	2-453

Rod Seal ON Profile

Catalog EPS 5370/USA

5



ON Cross-Section

ON Profile, PTFE Rod Cap Seal

The Parker ON profile is a bi-directional PTFE rod seal for use in low to medium duty hydraulic systems. The ON profile is a simple two piece design comprised of a standard size Parker o-ring energizing a wear resistant PTFE cap. The ON profile offers long wear and low friction, and because of its short assembly length, requires minimal space in the rod housing. The seal is commonly used in applications such as mobile hydraulics, machine tools, injection molding machines and hydraulic presses. Parker's ON profile will retrofit non-Parker seals of similar design.

The ON profile may be ordered without the energizer by omitting the energizer code. See part number nomenclature.

Technical Data

Standard Materials*	Temperature Range	Pressure Range†	Surface Speed
Cap 0401 40% Bronze-filled PTFE	-200°F to +575°F (-129°C to +302°C)	5000 psi (344 bar)	< 13 ft/s (4 m/s)
Energizer A 70A Nitrile	-30°F to +250°F (-34°C to +121°C)		

***Alternate Materials:** For applications that may require an alternate material, please see [Section 3](#) for alternate PTFE ([Table 3-4](#)) and energizer ([Table 3-5](#)) materials.

†Pressure Range without wear rings. If used with wear rings, see [Table 2-4, page 2-5](#).

Options

Notched side walls: Notches can be added to the side walls of the PTFE cap. This can help to optimize the seal's response to fluid pressure. Notched side walls help ensure that fluid pressure fills the cavity between the side face of the seal and the side face of the seal gland. Consult your local Parker seal representative for the availability and cost to add side notches to the ON profile.

N = Notched walls 

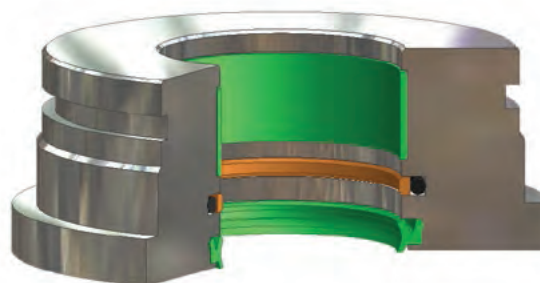

ON installed in Rod Gland

06/01/2014

Part Number Nomenclature – ON Profile

Table 5-26. ON Profile

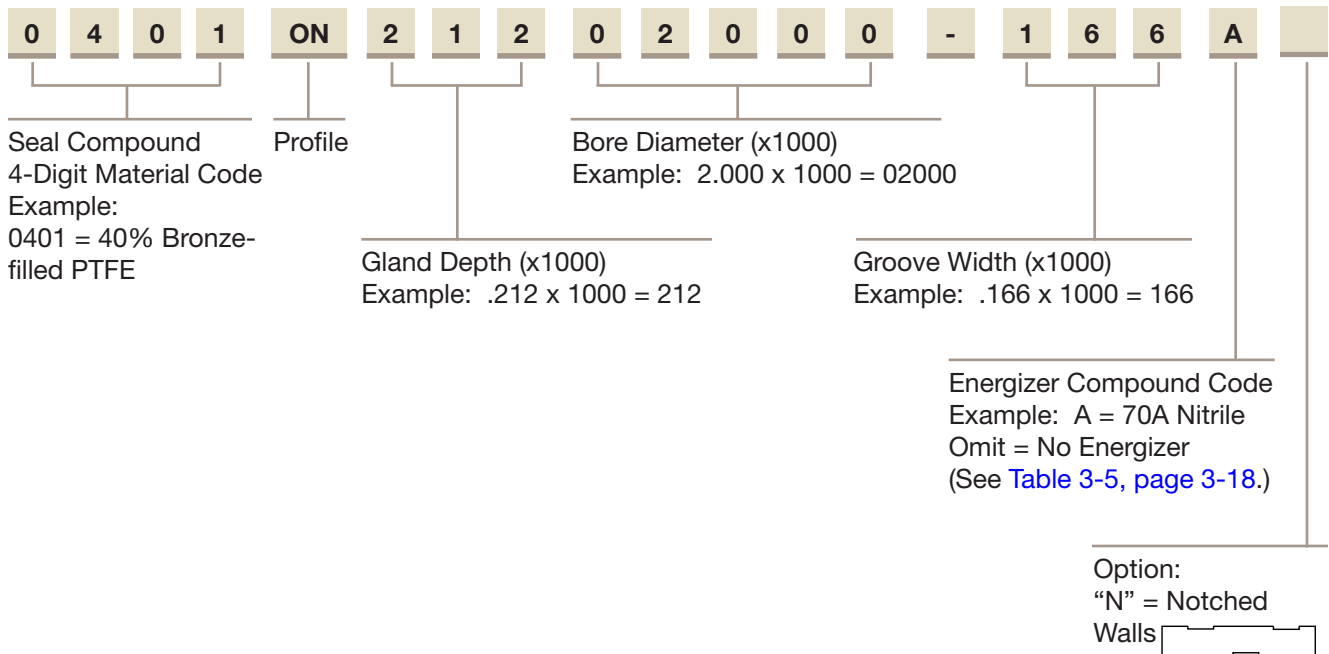

5

Gland Dimensions – ON Profile

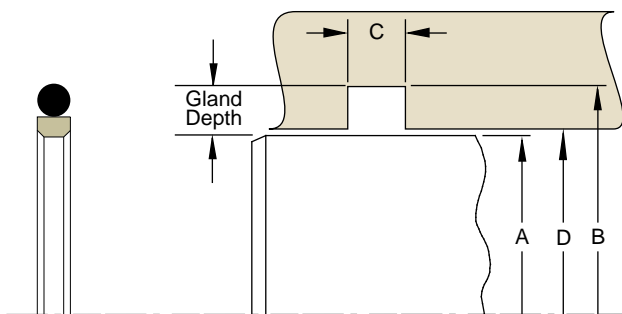

Please refer to [Engineering Section 2](#), [page 2-8](#) for surface finish and additional hardware considerations.

Table 5-27. ON Profile – Rod Gland Calculation

A Rod Diameter		Gland Depth	B Groove Diameter		C Groove Width +.005/- .000	D Throat Diameter*	
Range	Tol		Calculation	Tol		Calculation	Tol
0.500-0.999	+.000/- .001	0.087	Dia. A + .174	+.001/- .000	0.081	Dia. A + .001	+.001/- .000
1.000-1.999	+.000/- .002	0.149	Dia. A + .298	+.002/- .000	0.126	Dia. A + .001	+.002/- .000
2.000-3.999	+.000/- .003	0.212	Dia. A + .424	+.003/- .000	0.166	Dia. A + .001	+.003/- .000
4.000-7.999	+.000/- .004	0.308	Dia. A + .616	+.004/- .000	0.247	Dia. A + .002	+.004/- .000
8.000-16.000	+.000/- .005	0.415	Dia. A + .830	+.005/- .000	0.320	Dia. A + .002	+.005/- .000

*If used with wear rings, refer to wear ring throat diameter, see [Section 9](#). For custom groove calculations, see [Appendix C](#).

Above table reflects recommended cross-sections for rod diameters shown. Alternate cross-sections and additional sizes may be considered. Consult www.parker.com/eps/FluidPower for hardware specifications, additional cross-sections and sizes, and part number availability. Contact your Parker representative for assistance.

Rod Seal CR Profile

Catalog EPS 5370/USA

5

CR Profile, PTFE Rod Cap Seal to Retrofit O-ring Glands



The Parker CR profile is a cap seal with anti-extrusion, low friction and low wear features. The seal is a bi-directional rod seal for use in pneumatic and low to medium duty applications. Because of its short assembly length, it requires minimal space in the rod housing. The three CR profiles will fit into standard o-ring grooves without modification. Parker's CR profiles will retrofit non-Parker seals of similar design.

- CR0 fits a standard o-ring groove
- CR1 fits an o-ring groove designed for one back-up ring
- CR2 fits an o-ring groove designed for two back-up rings

The CR profile may be ordered without the energizer by omitting the energizer code. See part number nomenclature.

Technical Data

Standard Materials*	Temperature Range	Pressure Range†	Surface Speed
Cap 0401 40% Bronze-filled PTFE	-200°F to +575°F (-129°C to +302°C)	5000 psi (344 bar)	< 13 ft/s (4 m/s)
Energizer A 70A Nitrile	-30°F to +250°F (-34°C to +121°C)		



CR Cross-Section

***Alternate Materials:** For pneumatic applications, compound 0102 is recommended. For applications that may require an alternate material, please see [Section 3](#) for alternate PTFE ([Table 3-4](#)) and energizer ([Table 3-5](#)) materials.

†**Pressure Range** without wear rings. If used with wear rings, see [Table 2-4, page 2-5](#).

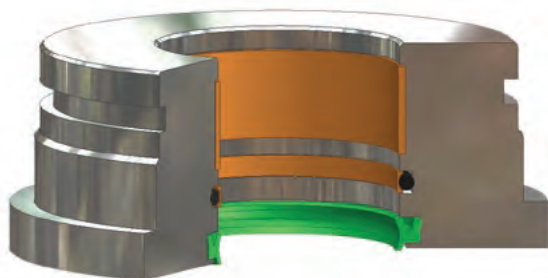

CR installed in Rod Gland

Option

Notched side walls: Notches can be added to the side walls of the PTFE cap. This can help to optimize the seal's response to fluid pressure. Notched side walls help ensure that fluid pressure fills the cavity between the side face of the seal and the side face of the seal gland. Consult your local Parker seal representative for the availability and cost to add side notches to the CR profile.

N = Notched walls 

06/01/2014

Part Number Nomenclature – CR Profile

Table 5-28. CR Profile

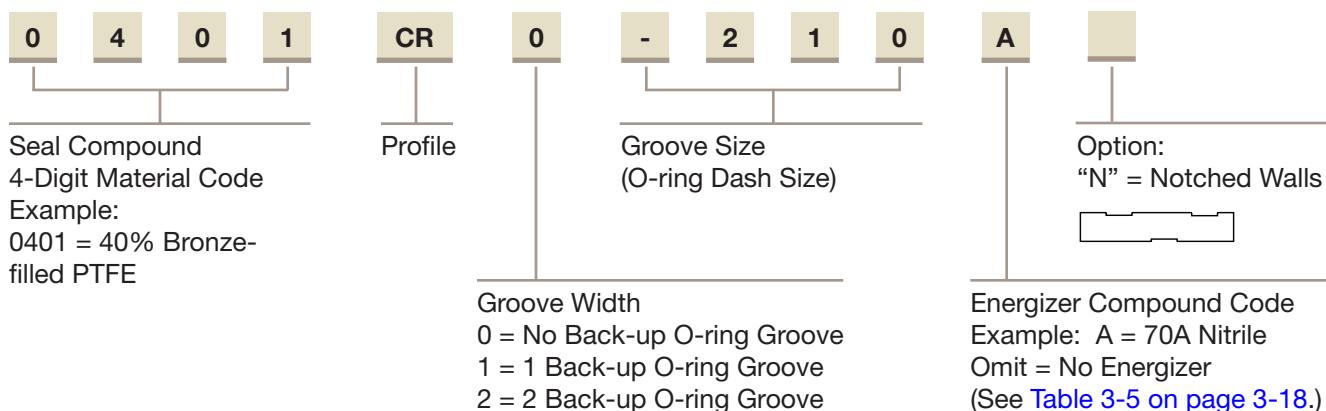

Gland Dimensions – CR Profile

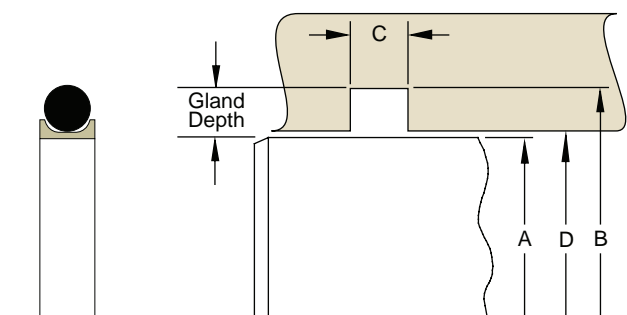

Please refer to [Engineering Section 2, page 2-8](#) for surface finish and additional hardware considerations.

5

Table 5-29. CR Profile – Rod Gland Calculation

A Rod Diameter	O-Ring Dash #	B Groove Diameter	C CR0 Groove Width	C CR1 Groove Width	C CR2 Groove Width	D Throat Diameter*	
						Calculation	Tol
+ .000/- .002		+ .002/- .000	+ .005/- .000	+ .005/- .000	+ .005/- .000		
0.125 - 0.437	2-006 to 2-013	Dia. A + .110	0.093	0.138	0.205	Dia. A + .001	+ .001/- .000
0.500 - 0.812	2-112 to 2-117	Dia. A + .176	0.140	0.171	0.238	Dia. A + .001	+ .002/- .000
0.875 - 1.500	2-212 to 2-222	Dia. A + .242	0.187	0.208	0.275	Dia. A + .001	+ .002/- .000
1.625 - 4.375	2-326 to 2-348	Dia. A + .370	0.281	0.311	0.410	Dia. A + .002	+ .003/- .000
4.500 - 16.000	2-425 to 2-461	Dia. A + .474	0.375	0.408	0.538	Dia. A + .004	+ .004/- .000

*If used with wear rings, refer to wear ring throat diameter, see [Section 9](#). For custom groove calculations, see [Appendix C](#).

Above table reflects recommended cross-sections for rod diameters shown. Alternate cross-sections and additional sizes may be considered. Consult www.parker.com/eps/FluidPower for hardware specifications, additional cross-sections and sizes, and part number availability. Contact your Parker representative for assistance.

Rod Seal OC Profile

Catalog EPS 5370/USA

5



OC Cross-Section

OC Profile, Compact PTFE Rod Cap Seal

The Parker OC profile is a bi-directional rod seal for use in pneumatic and low to medium duty hydraulic systems. The OC profile is a two-piece design utilizing a rectangular PTFE cap and standard size Parker o-ring. The OC profile is an excellent choice for applications requiring a compact design. The unique properties of the modified PTFE provide added wear resistance for improved cycle life. Parker's OC profile will retrofit non-Parker seals of similar design.

The OC profile may be ordered without the energizer by omitting the energizer code. See part number nomenclature.

Technical Data

Standard Materials*	Temperature Range	Pressure Range†	Surface Speed
Cap 0102 Modified PTFE	-320°F to +450°F (-195°C to +282°C)	1,500 psi (103 bar)	< 13 ft/s (4 m/s)
Energizer A	70A Nitrile	-30°F to +250°F (-34°C to +121°C)	

***Alternate Materials:** For applications that may require an alternate material, please see [Section 3](#) for alternate PTFE ([Table 3-4](#)) and energizer ([Table 3-5](#)) materials.

†Pressure Range without wear rings. If used with wear rings, see [Table 2-4, page 2-5](#).

Option

Notched side walls: Notches can be added to the side walls of the PTFE cap. This can help to optimize the seal's response to fluid pressure. Notched side walls help ensure that fluid pressure fills the cavity between the side face of the seal and the side face of the seal gland. Consult your local Parker seal representative for the availability and cost to add side notches to the OC profile.

N= Notched walls 

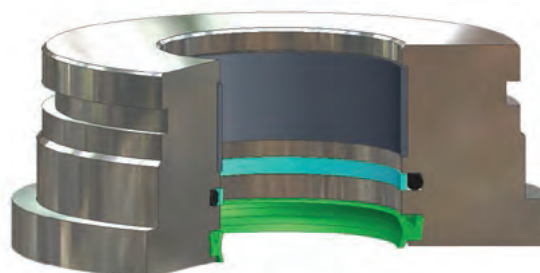

OC installed in Rod Gland

06/01/2014

Part Number Nomenclature – OC Profile

Table 5-30. OC Profile

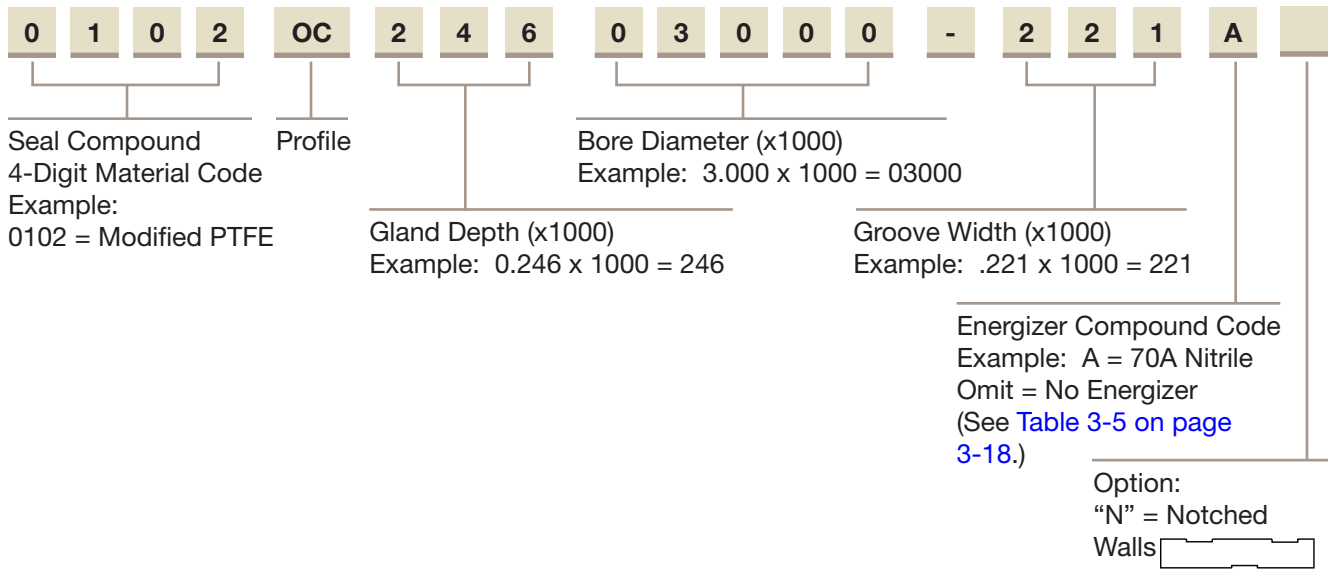

Gland Dimensions – OC Profile

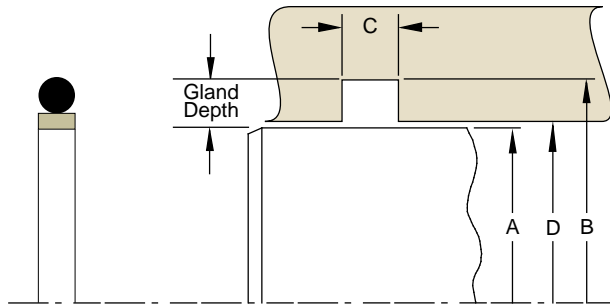

Please refer to [Engineering Section 2, page 2-8](#) for surface finish and additional hardware considerations.

Table 5-31. OC Profile – Rod Gland Calculation

A Rod Diameter		Gland Depth	B Groove Diameter		C Groove Width	D Throat Diameter*	
Range	Tol		Calculation	Tol		Calculation	Tol
0.125 - 0.249	+0.000/-0.001	0.072	Dia. A + .143	+0.001/-0.000	0.079	Dia. A + .001	+0.002/-0.000
0.250 - 0.374	+0.000/-0.001	0.087	Dia. A + .174	+0.001/-0.000	0.079	Dia. A + .001	+0.002/-0.000
0.375 - 0.749	+0.000/-0.003	0.118	Dia. A + .236	+0.003/-0.000	0.112	Dia. A + .001	+0.002/-0.000
0.750 - 1.499	+0.000/-0.004	0.150	Dia. A + .300	+0.004/-0.000	0.149	Dia. A + .001	+0.002/-0.000
1.500 - 4.499	+0.000/-0.005	0.246	Dia. A + .491	+0.005/-0.000	0.221	Dia. A + .001	+0.003/-0.000
4.500 - 5.999	+0.000/-0.006	0.297	Dia. A + .593	+0.006/-0.000	0.297	Dia. A + .002	+0.004/-0.000
6.000 - 7.999	+0.000/-0.006	0.359	Dia. A + .718	+0.006/-0.000	0.297	Dia. A + .002	+0.004/-0.000
8.000 - 15.000	+0.000/-0.006	0.484	Dia. A + .968	+0.006/-0.000	0.297	Dia. A + .002	+0.005/-0.000

*If used with wear rings, refer to wear ring throat diameter, see [Section 9](#). For custom groove calculations, see [Appendix C](#).

Above table reflects recommended cross-sections for rod diameters shown. Alternate cross-sections and additional sizes may be considered. Consult www.parker.com/eps/FluidPower for hardware specifications, additional cross-sections and sizes, and part number availability. Contact your Parker representative for assistance.

Rod Seal OD Profile



OD Cross-Section

OD Profile, PTFE Buffer Seal

The Parker OD profile is a rod seal that can be used as a buffer seal in conjunction with a primary rod seal or in tandem with itself to form a sealing system for higher performance. The OD profile is a uni-directional seal, with a unique design that allows trapped fluid pressure back into the cylinder. When the rod extends from the cylinder the OD profile is riding on a sealing point, creating a high compression point to limit leakage. As the rod goes through its return stroke this seal rocks forward, creating a larger sealing surface on the rod. The compression force is spread out over a larger area allowing trapped fluid to pass under the seal and return to the system. This pressure relief feature allows the OD profile to be used in tandem or multiple seal arrangements. The OD features low friction, long life, and versatility.

The OD profile may be ordered without the energizer by omitting the energizer code. See part number nomenclature.

Technical Data

Standard Materials*	Temperature Range	Pressure Ranges†	Surface Speed
Cap 0401 40% Bronze-filled PTFE	-200°F to +575°F (-129°C to +302°C)	5000 psi (344 bar)	> 13 ft/s (4 m/s)
Energizer A 70A Nitrile	-30°F to +250°F (-34°C to +121°C)		

*Alternate Materials: For applications that may require an alternate material, please see Section 3 for alternate PTFE (Table 3-4) and energizer (Table 3-5) materials.

†Pressure Range without wear rings. If used with wear rings, see Table 2-4, page 2-5.

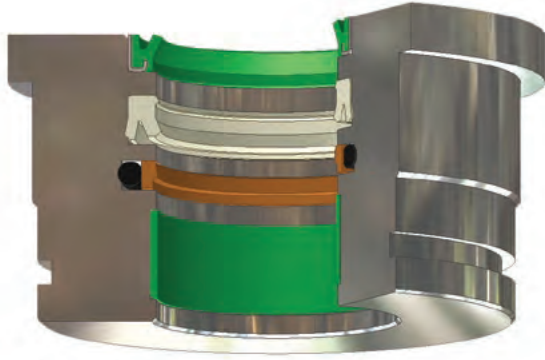

OD installed in Rod Gland

Part Number Nomenclature – OD Profile

Table 5-32. OD Profile

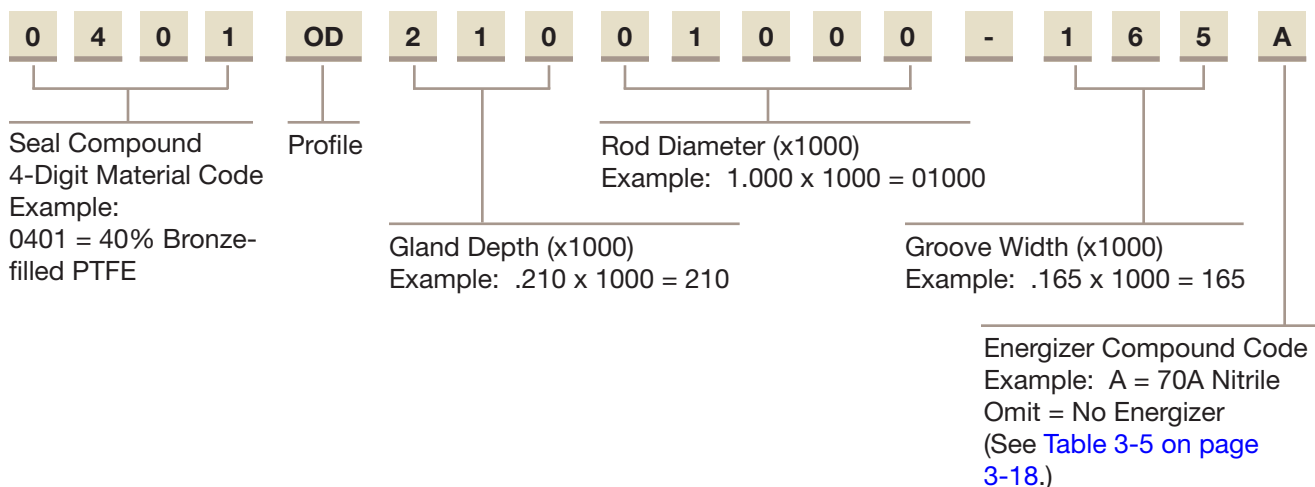

Gland Dimensions – OD Profile

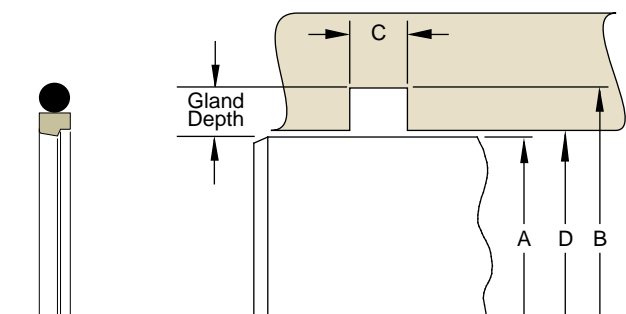

Please refer to [Engineering Section 2, page 2-8](#) for surface finish and additional hardware considerations.

Table 5-33. OD Profile – Rod Gland Calculation

A Rod Diameter		Gland Depth	B Groove Diameter		C Groove Width +.008/- .000	D Throat Diameter*	
Range	Tol		Calculation	Tol		Calculation	Tol
0.312 - 0.749	+.000/- .002	0.143	Dia. A + .286	+.001/- .002	0.126	Dia. A + .001	+.002/- .000
0.750 - 1.499	+.000/- .002	0.210	Dia. A + .420	+.002/- .000	0.165	Dia. A + .001	+.002/- .000
1.500 - 7.999	+.000/- .003	0.297	Dia. A + .594	+.003/- .000	0.248	Dia. A + .001	+.003/- .000
8.000 - 9.999	+.000/- .004	0.403	Dia. A + .806	+.004/- .000	0.247	Dia. A + .002	+.004/- .000
10.000 - 20.000	+.000/- .006	0.472	Dia. A + .944	+.006/- .000	0.319	Dia. A + .002	+.005/- .000

*If used with wear rings, refer to wear ring throat diameter, see [Section 9](#). For custom groove calculations, see [Appendix C](#).

Above table reflects recommended cross-sections for rod diameters shown. Alternate cross-sections and additional sizes may be considered. Consult www.parker.com/eps/FluidPower for hardware specifications, additional cross-sections and sizes, and part number availability. Contact your Parker representative for assistance.



Rod Seal V6 Profile

Catalog EPS 5370/USA

V6 Profile, Pneumatic Cushion Seal

The V6 profile provides a check valve type action for use in cushioning pneumatic cylinders. The V6 profile seals against the cushioning piston or spud, allowing pneumatic pressure to build and cushion the cylinder's end stroke. Through a series of slots and pedestals the intake flow is then able to easily blow past the cushion seal to fill the cylinder. The installation of the cushion seal is very simple as it manually snaps into the groove recess. The V6 profile is available in proprietary Parker compounds formulated for low friction, extrusion resistance, and high temperature. The V6 profile can be used in a wide variety of NFPA cylinders and will provide excellent performance and long life.



Technical Data

Standard Materials	Temperature Range	Pressure Rangef	Surface Speed
P4622A90	-65°F to +225°F (-54°C to +107°C)	250 psi (17 bar)	< 3 ft/s (1 m/s)
N4180A80	-40°F to +250°F (-40°C to +121°C)	250 psi (17 bar)	< 3 ft/s (1 m/s)
N4181A80	-40°F to +250°F (-40°C to +121°C)	250 psi (17 bar)	< 3 ft/s (1 m/s)
V4208A90	-5°F to +400°F (-21°C to +204°C)	250 psi (17 bar)	< 3 ft/s (1 m/s)

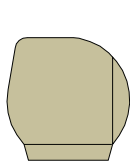

V6 Cross-Section

Alternate Materials: For applications that may require an alternate material, please go to www.parker.com/eps/FluidPower to check current tooling and part number availability, or contact your local Parker representative.

†**Pressure Range** without wear rings. If used with wear rings, see [Table 2-4](#), [page 2-5](#).

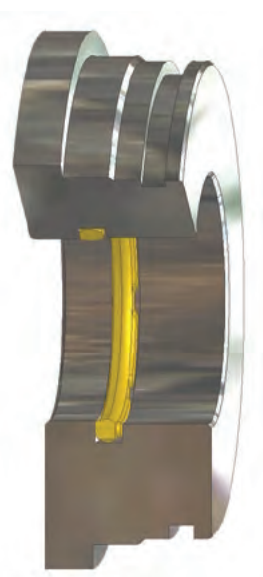

V6 Installed in Rod Gland

Part Number Nomenclature – V6 Profile

Table 5-34. V6 Profile

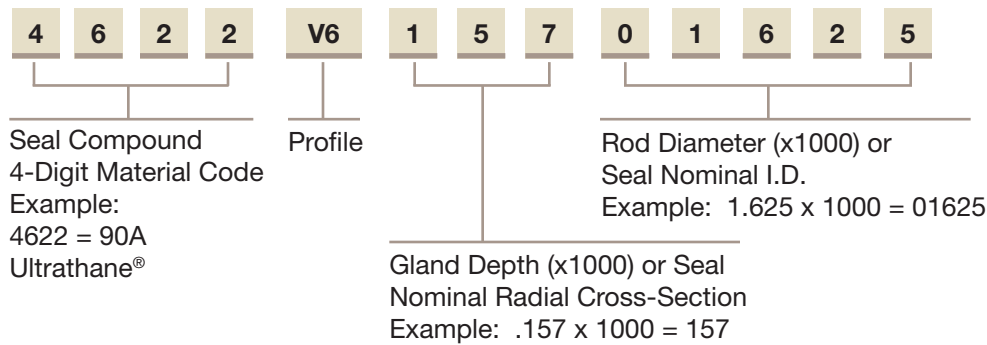

Gland Dimensions – V6 Profile

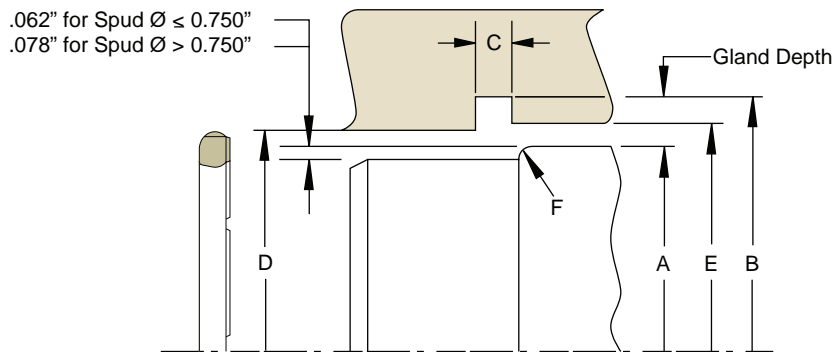

Please refer to [Engineering Section 2, page 2-8](#) for surface finish and additional hardware considerations.



Table 5-35. V6 Profile – Rod Gland Calculation

Nominal Spud Diameter	Gland Depth	A Spud Diameter	B Groove Diameter	C Groove Width	D Throat Diameter	E Throat Diameter	F Spud End Radius
3/8	0.157	0.368/0.370	0.685/0.689	0.181/0.197	0.390/0.393	0.449/0.453	0.118
5/8	0.157	0.617/0.620	0.935/0.940	0.181/0.197	0.640/0.644	0.699/0.703	0.118
3/4	0.157	0.742/0.745	1.060/1.065	0.181/0.197	0.765/0.769	0.824/0.828	0.118
7/8	0.157	0.877/0.880	1.195/1.201	0.181/0.197	0.900/0.905	0.959/0.964	0.118
1	0.157	0.992/0.995	1.310/1.315	0.181/0.197	1.015/1.019	1.074/1.078	0.118
1-3/16	0.197	1.179/1.184	1.578/1.585	0.228/0.244	1.208/1.215	1.263/1.270	0.157
1-1/4	0.157	1.249/1.253	1.568/1.574	0.181/0.197	1.273/1.279	1.332/1.338	0.118
1-5/8	0.157	1.620/1.624	1.939/1.945	0.181/0.197	1.644/1.650	1.703/1.709	0.118
1-5/8	0.197	1.616/1.622	2.016/2.023	0.228/0.244	1.646/1.653	1.701/1.709	0.157
2	0.197	1.992/1.997	2.391/2.398	0.228/0.244	2.021/2.028	2.076/2.083	0.157
2-1/4	0.157	2.242/2.247	2.562/2.569	0.181/0.197	2.267/2.274	2.326/2.333	0.118
2-3/4	0.276	2.735/2.740	3.291/3.300	0.323/0.339	2.764/2.771	2.858/2.865	0.197
4-1/4	0.276	4.219/4.225	4.776/4.786	0.323/0.339	4.249/4.258	4.343/4.352	0.197

Above table reflects recommended cross-sections for diameters shown. Alternate cross-sections and additional sizes may be considered. Consult www.parker.com/eps/FluidPower for hardware specifications, additional cross-sections and sizes, and part number availability. Contact your Parker representative for assistance.

Rod Seal OR Profile

Catalog EPS 5370/USA

5



OR Cross-Section

OR Profile, Rotary PTFE Cap Seal

The Parker OR profile is a bi-directional rod seal for use in pneumatic and low to medium duty rotary or oscillating applications. The OR profile is a two piece design comprised of a standard size o-ring energizing a wear resistant PTFE cap. The OR profile offers long wear and low friction without stick-slip. This PTFE outer diameter is designed with a special interference with the o-ring to eliminate spinning between the o-ring and seal. Special grooves are designed into the PTFE inner diameter to provide lubrication and create a labyrinth effect for reduced leakage. The seal is commonly used in swivel joints, hose reels, and machine applications. Parker's OR profile will retrofit non-Parker seals of similar design.

The OR profile may be ordered without the energizer by omitting the energizer code. See part number nomenclature.

Technical Data

Standard Materials*	Temperature Range	Pressure Range†	Surface Speed
Cap			
0205 15% Fiberglass-, 5% MoS ₂ -filled PTFE	-200°F to +575°F (-129°C to +302°C)	3000 psi (206 bar)	< 3.3 ft/s (1.0 m/s)
Energizer			
A 70A Nitrile	-30°F to +250°F (-34°C to +121°C)		

***Alternate Materials:** For applications that may require an alternate material, please see [Section 3](#) for alternate PTFE ([Table 3-4](#)) and energizer ([Table 3-5](#)) materials.

†Pressure Range without wear rings. If used with wear rings, see [Table 2-4, page 2-5](#).

Minimum rotary shaft hardness = 60 Rc.

Note: Small size cross sections feature single outer diameter grooves. Cross sections 0.305" and greater feature dual grooves.

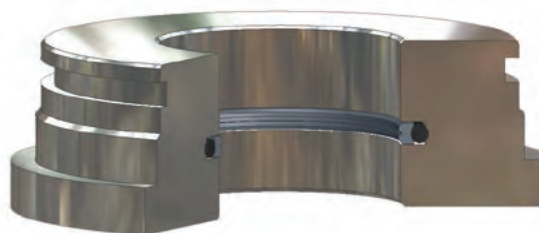

OR installed on Rotary Shaft Gland

06/01/2014

Part Number Nomenclature – OR Profile

Table 5-36. OR Profile

0	2	0	5	OR	1	4	8	0	2	0	0	0	-	1	2	6	A
Seal Compound 4-Digit Material Code Example: 0205 = 15% Fiberglass-, 5% MoS ₂ -filled PTFE				Profile	Gland Depth (x1000) Example: .148 x 1000 = 148			Bore Diameter (x1000) Example: 2.000 x 1000 = 02000			Groove Width (x1000) Example: .126 x 1000 = 126			Energizer Compound Code Example: A = 70A Nitrile Omit = No Energizer (See Table 3-5 on page 3-18.)			
Option: N = Notched Walls																	

Gland Dimensions – OR Profile

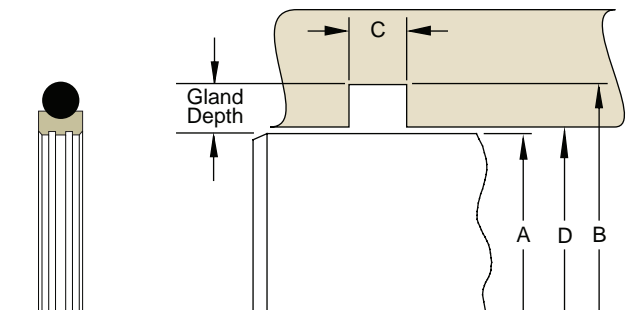

Please refer to [Engineering Section 2, page 2-8](#) for surface finish and additional hardware considerations.

Table 5-37. OR Profile – Rod Gland Calculation

A Rod Diameter		Gland Depth	B Groove Diameter		C Groove Width +.008/-0.000	D Throat Diameter*	
Range	Tol		Calculation	Tol		Calculation	Tol.
0.313 - 1.499	+.000/-0.002	0.097	Dia. A + .193	+.002/-0.000	0.087	Dia. A + .001	+.002/-0.000
1.500 - 2.999	+.000/-0.003	0.148	Dia. A + .295	+.003/-0.000	0.126	Dia. A + .001	+.002/-0.000
3.000 - 5.999	+.000/-0.004	0.217	Dia. A + .433	+.004/-0.000	0.165	Dia. A + .001	+.003/-0.000
6.000 - 11.999	+.000/-0.005	0.305	Dia. A + .610	+.005/-0.000	0.248	Dia. A + .002	+.004/-0.000
12.000 - 20.000	+.000/-0.006	0.414	Dia. A + .827	+.006/-0.000	0.319	Dia. A + .002	+.005/-0.000

*If used with wear rings, refer to wear ring throat diameter, see [Section 9](#). For custom groove calculations, see [Appendix C](#).

Above table reflects recommended cross-sections for rod diameters shown. Alternate cross-sections and additional sizes may be considered. Consult www.parker.com/eps/FluidPower for hardware specifications, additional cross-sections and sizes, and part number availability. Contact your Parker representative for assistance.

5

Symmetrical Seals for Rod or Piston Applications

Contents

Product Offering 6-2

Decision Tree

 Rod.....5-3 and 5-4

 Piston7-3 and 7-4

PolyPak® Sealing..... 6-3

Profiles

 SPP - Standard PolyPak..... 6-6

 DPP - Deep PolyPak..... 6-10

 BPP - Type B PolyPak 6-14

◆ 8400 and 8500..... 6-18

 SL..... 6-24

 US..... 6-27

 AN6226 6-30

Symmetrical Profiles

Parker symmetrical profiles are designed to fit the center of the gland. They are categorized as symmetrical profiles because the shape of the outside diameter sealing lip matches the shape of the inside diameter sealing lip. This symmetrical design, with its centered fit in the gland, allows the profile to function either as a rod or piston seal. Parker's wide range of profile options, proprietary compounds, and sizes establish Parker as a leader in the industry, providing quality solutions for pneumatic and hydraulic applications.

Typical Hydraulic Cylinder

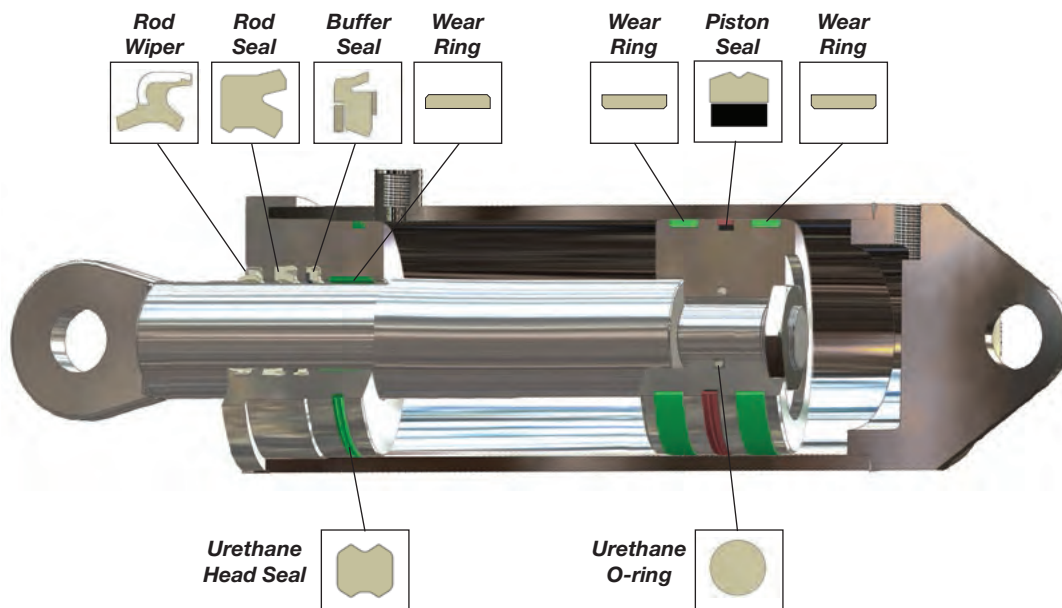



























Symmetrical Seal Product Offering (For Rod or Piston Applications)

Catalog EPS 5370/USA

Profiles

Table 6-1: Product Profiles

Series	Description	Application (Duty)				Page
		Light	Medium	Heavy	Pneumatic	
SPP 	Square Cross-Section O-ring Energized Lip Seal					6-6
DPP 	O-ring Loaded Lip Seal with Straight Cut, Scraper Lip Design					6-10
BPP 	O-ring Energized Lip Seal with Beveled Lip Design					6-14
SL 	Dual Compound Dual Lip Seal					6-24
US 	Symmetrical U-cup Seal					6-27

Series	Description	Application (Duty)				Page
		Light	Medium	Heavy	Pneumatic	
8400 	Light Load U-cup with Beveled Lips					6-18
8500 	Light Load U-cup with Straight Cut, Scraper Lips					6-18
AN6226 	Symmetrical U-cup per Army/Navy (AN) Specification					6-30

6

Symmetrical Seal Decision Tree

The Symmetrical product offerings are a part of the Decision Trees in the Rod and Piston sections (Sections 5 and 7). These Decision Trees are found on pages 5-3, 5-4, 7-3 and 7-4.

Symmetrical Seals

PolyPak® Sealing

Catalog EPS 5370/USA



PolyPak® Sealing

Parker's PolyPak® seal is a patented precision molded multi-purpose seal. The Parker PolyPak combines an o-ring type synthetic rubber o-spring with a conventional lip-type seal to produce a unique sealing device capable of sealing both vacuum, high and low pressure.

Conventional lip seals, such as the standard u-cups are prone to leakage under low pressure because little or no lip loading is inherent in the basic seal design. The Parker PolyPak however, is a squeeze type seal and provides high sealability at low pressure. As system pressure increases, additional force is applied to the PolyPak's seal interface and as pressure continues to increase, lip loading is automatically increased to compensate for this higher pressure and thus maintain a positive, leak-free seal from hard vacuum to over 60,000 psi with proper design and auxiliary devices.

In addition to providing superior sealing in vacuum, low and high pressure applications, the PolyPak seal offers a number of distinct advantages over conventional symmetrical or non-symmetrical u-cup seals including:

- The PolyPak seal's o-spring energizer stabilizes the seal under extreme pressures, preventing seal lip distortion and rolling or twisting in the gland.
- At low or high temperature extremes, the o-spring maintains lip loading on both I.D. and O.D. of the seal interface.
- The PolyPak seal can be stretched or squeezed to accommodate oversize cylinder bores and undersize rods. As long as the seal cross-section is correct in relation to the radial groove dimensions, the PolyPak will compensate and maintain proper lip loading.
- The range of materials available to the user of the PolyPak seal insures the proper combination for abrasion, extrusion, temperature resistance and fluid compatibility which produces high sealability and long life.

PolyPak seals are available in three styles:

1. Standard PolyPak (SPP Profile)
2. Deep PolyPak (DPP Profile)
3. Type B PolyPak (BPP Profile)

Rod Sealing with PolyPak® Seals

As a general rule, rod seals are more critical in nature than their companion piston seals. With increasing OEM requirements for “dry rod” capability, both to conserve system fluid and avoid leakage, the design and selection of the rod seal can be more challenging than its piston counterpart.

Parker recommends the use of the Type B PolyPak (BPP Profile) for rod seal applications due to its design features, including:

- Excellent film-breaking capability of the beveled lip design
- The higher level of lip loading provided by the Type B offers maximum sealability
- The long body of the design provides maximum stability

Piston Sealing with PolyPak Seals

Piston seals can be classified in two categories: single-acting and double-acting. The single acting seal is only required to seal in a single direction as system pressure is seen on only one end of the piston (return of the piston in a single-acting system is accomplished either by gravity or spring loading). The double-acting cylinder requires that the piston be sealed in both directions of stroke as system fluid is applied to one side or the other to achieve movement.

Please see the individual PolyPak profile pages for explanation and differentiation on selecting PolyPak profiles for piston applications.

PolyPak Material Combinations

PolyPak seals can be configured in numerous o-spring energizer and shell combinations. Table 6-2 represents “standard” combinations. Care should be taken to insure that both the PolyPak shell and its companion o-spring energizer are compatible with the system temperature, pressure, and fluid requirements.

Table 6-2. Standard Shell and O-Spring Energizer Combinations for PolyPak Seals

PolyPak Shell	O-Spring Energizer
Molythane®	70A Nitrile
Polymyte®	70A Nitrile, 75A FKM
Nitroxile®	70A Nitrile
Ethylene Propylene	80A EPR
Fluorocarbon	75A FKM
All Plastic and Rubber	Metal O-spring

Parker’s “smart” part numbering provides for varying standard and custom PolyPak shell and o-spring energizer material combinations. Please refer to the part number nomenclature tables and Technical Data in the PolyPak profile pages for PolyPak shell material options. See [Table 6-3](#) for standard and custom o-spring energizer option details.

Positively-Actuated Back-ups Option

PolyPak seals can be designed with positively-actuated back-ups by designating that option in the part number. See [page 10-16](#) for an explanation of the features of positively-actuated back-ups.

Table 6-3. PolyPak® O-Spring Energizers

Standard O-Spring Energizer		
O-Spring Energizer Code	Type of PolyPak	Description
	Urethane (4615, 4622)	70A NBR o-spring energizer
- (dash)	Rubber	Indicates that the o-spring material family is to match the rubber PolyPak shell material family. Example: XNBR 4263 PolyPak shell: code (“-”) indicates NBR o-ring EPR 4207 PolyPak shell: code (“-”) indicates EPR o-ring FKM 4208 PolyPak shell: code (“-”) indicates FKM o-ring FKM 4266 PolyPak shell: code (“-”) indicates FKM o-ring
	Polymyte® (4651)	Must be replaced by a custom o-spring energizer code
Custom O-Spring Energizers		
O-Spring Energizer Code	Energizer Description	
C	Continuous o-ring	
E	General EPR o-ring	
J	General HNBR o-ring	
L	Canted coil, spring-loaded with oval spring cavity	
N	General nitrile o-ring	
R	Low swell nitrile o-ring	
S	Spring energizer with o-ring groove	
U	Geothermal EPR o-ring	
V	Fluorocarbon o-ring	
W	Nuclear grade EPR o-ring	
X	Premium grade low-temperature o-ring	
Y	Low temperature nitrile o-ring	

Symmetrical Seal SPP Profile, Standard PolyPak®

Catalog EPS 5370/USA

SPP Profile, Standard PolyPak® Square Cross-Section O-ring Energized Lip Seal



Parker's Standard PolyPak is a squeeze seal with a symmetrical profile for use in either rod or piston applications. The standard Molythane® shell provides high wear resistance and the o-ring energizer functions as a spring to maintain sealing contact under low pressure. The Standard PolyPak utilizes a straight cut scraper lip design formed by a precision trimming process. The scraper edge wipes both fluid film and contamination away from the seal. A wide selection of sizes and alternate compounds allow this profile to match up with many hydraulic applications. The Standard PolyPak is an economical choice as a stand alone rod or piston seal. With less squeeze force than the Deep or Type B profiles, the Standard PolyPak can be installed back-to-back, in separate glands, for bi-directional sealing. To protect against pressure trapping, it is recommended that the o-ring be removed from the Standard PolyPak facing the lower pressure side of the application.

6



Standard PolyPak Cross-Section

Technical Data

Standard Materials*	Temperature Range	Pressure Range†	Surface Speed
Shell			
P4615A90	-65°F to +200°F (-54°C to +93°C)	5000 psi (345 bar)	< 1.6 ft/s (0.5 m/s)
P4622A90	-65°F to +225°F (-54°C to +107°C)	5000 psi (345 bar)	< 1.6 ft/s (0.5 m/s)
Z4651D60	-65°F to +275°F (-54°C to +135°C)	7000 psi (482 bar)	< 1.6 ft/s (0.5 m/s)
N4263A90	-20°F to +275°F (-29°C to +135°C)	2000 psi (138 bar)	< 1.6 ft/s (0.5 m/s)
E4207A90	-65°F to +300°F (-54°C to +149°C)	2000 psi (138 bar)	< 1.6 ft/s (0.5 m/s)
V4208A90	-5°F to +400°F (-21°C to +204°C)	2000 psi (138 bar)	< 1.6 ft/s (0.5 m/s)
V4266A95	-5°F to +400°F (-21°C to +204°C)	2250 psi (155 bar)	< 1.6 ft/s (0.5 m/s)

Energizer

For Seals With...	Standard Energizer Material*
4615 or 4622 PolyPak shell	Standard energizer is a nitrile o-ring
4651 PolyPak shell	O-spring energizer code must be identified
Rubber PolyPak shell	Standard energizer is an o-ring from the same rubber material family as the shell

***Alternate Materials:** For custom energizer materials, see [Table 6-3 on page 6-5](#). For applications that may require an alternate shell material, please see [Section 3](#) or contact your local Parker representative.

†**Pressure Range** without wear rings. If used with wear rings, see [Table 2-4, page 2-5](#).

06/01/2014

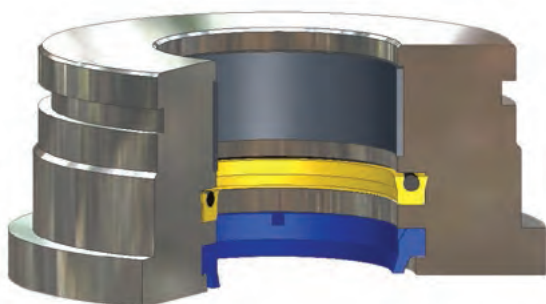

*Standard PolyPak installed
in Rod Gland*

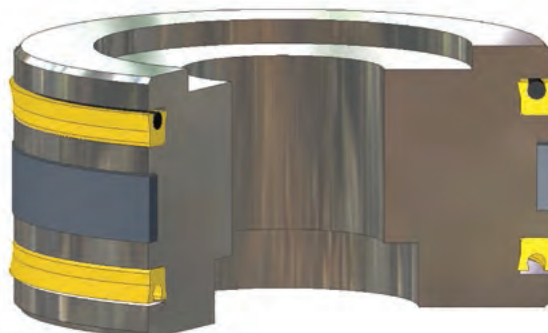

*Standard PolyPak installed
in Piston Gland*

Part Number Nomenclature – SPP Profile, Standard PolyPak®

Table 6-4. SPP Profile, Standard PolyPak

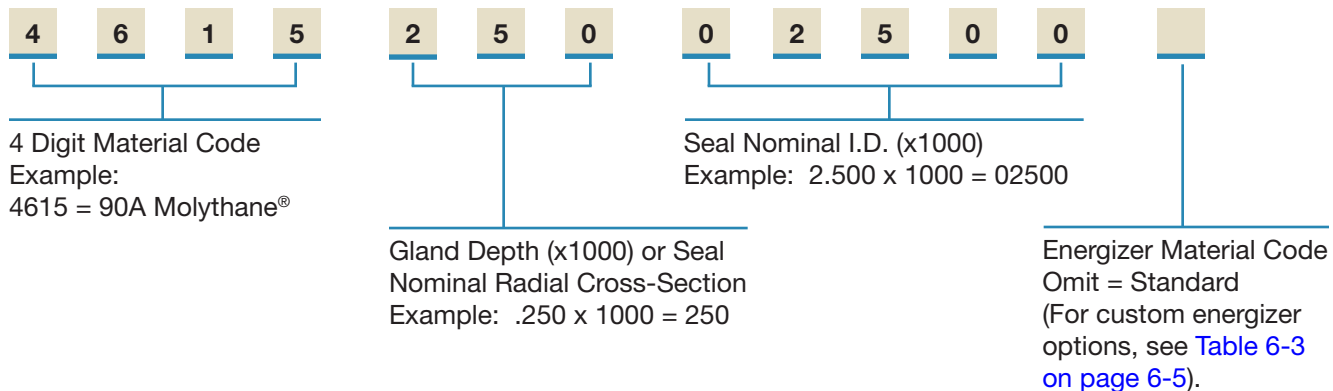

Rod Gland Dimensions — SPP Profile, Standard PolyPak®

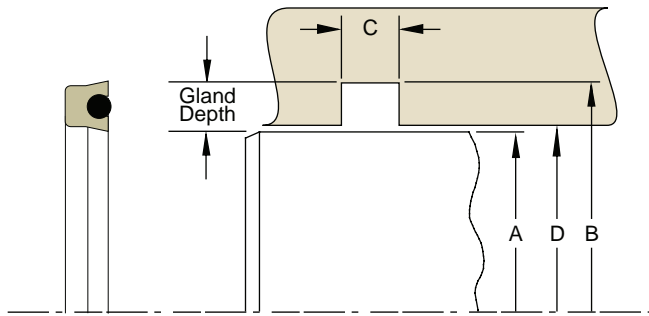

Please refer to Engineering [Section 2](#), [page 2-8](#) for surface finish and additional hardware considerations.

Table 6-5. SPP Profile — Rod Gland Calculation, Rubber and Polyurethane (90A)

A Rod Diameter		Seal		B Groove Diameter		C Groove Width	D Throat Diameter*	
Range	Tol.	Cross Section	Axial Width	Calculation	Tol.	+0.015/ -0.000	Calculation	Tol.
0.062 - 0.624	+0.000/-0.001	1/8 (.125)	1/8 (.125)	Dia. A + .250	+0.002/-0.000	0.138	Dia. A + .001	+0.002/-0.000
0.625 - 0.999	+0.000/-0.001	1/8 (.125)	1/8 (.125)	Dia. A + .250	+0.002/-0.000	0.138	Dia. A + .001	+0.002/-0.000
1.000 - 1.499	+0.000/-0.002	3/16 (.187)	3/16 (.187)	Dia. A + .375	+0.002/-0.000	0.206	Dia. A + .001	+0.002/-0.000
1.500 - 1.999	+0.000/-0.002	3/16 (.187)	3/16 (.187)	Dia. A + .375	+0.002/-0.000	0.206	Dia. A + .001	+0.002/-0.000
2.000 - 3.499	+0.000/-0.002	1/4 (.250)	1/4 (.250)	Dia. A + .500	+0.003/-0.000	0.275	Dia. A + .001	+0.003/-0.000
3.500 - 4.999	+0.000/-0.002	5/16 (.312)	5/16 (.312)	Dia. A + .625	+0.004/-0.000	0.343	Dia. A + .002	+0.003/-0.000
5.000 - 9.999	+0.000/-0.002	3/8 (.375)	3/8 (.375)	Dia. A + .750	+0.005/-0.000	0.413	Dia. A + .002	+0.004/-0.000
10.000 - 19.999	+0.000/-0.003	1/2 (.500)	1/2 (.500)	Dia. A + 1.000	+0.007/-0.000	0.550	Dia. A + .002	+0.005/-0.000
20.000 - 29.999	+0.000/-0.003	5/8 (.625)	5/8 (.625)	Dia. A + 1.250	+0.009/-0.000	0.688	Dia. A + .002	+0.006/-0.000
30.000 - 39.999	+0.000/-0.004	3/4 (.750)	3/4 (.750)	Dia. A + 1.500	+0.011/-0.000	0.825	Dia. A + .002	+0.007/-0.000
40.000 +	+0.000/-0.005	1 (1.000)	1 (1.000)	Dia. A + 2.000	+0.015/-0.000	1.100	Dia. A + .002	+0.009/-0.000

Table 6-6. SPP Profile — Rod Gland Calculation, Polymyte (60D)

A Rod Diameter		Seal		A Groove Diameter		C Groove Width	D Throat Diameter*	
Range	Tol.	Cross Section	Axial Width	Calculation	Tol.	+0.015/ -0.000	Calculation	Tol.
0.062 - 0.999	+0.000/-0.001	1/8 (.125)	1/8 (.125)	Dia. A + .250	+0.002/-0.000	0.138	Dia. A + .001	+0.002/-0.000
1.000 - 1.749	+0.000/-0.001	1/8 (.125)	1/8 (.125)	Dia. A + .250	+0.002/-0.000	0.138	Dia. A + .001	+0.002/-0.000
1.750 - 2.249	+0.000/-0.002	3/16 (.187)	3/16 (.187)	Dia. A + .375	+0.002/-0.000	0.206	Dia. A + .001	+0.002/-0.000
2.250 - 2.749	+0.000/-0.002	3/16 (.187)	3/16 (.187)	Dia. A + .375	+0.002/-0.000	0.206	Dia. A + .001	+0.002/-0.000
2.750 - 3.499	+0.000/-0.002	1/4 (.250)	1/4 (.250)	Dia. A + .500	+0.003/-0.000	0.275	Dia. A + .001	+0.003/-0.000
3.500 - 4.999	+0.000/-0.002	5/16 (.312)	5/16 (.312)	Dia. A + .625	+0.004/-0.000	0.343	Dia. A + .002	+0.003/-0.000
5.000 - 9.999	+0.000/-0.002	3/8 (.375)	3/8 (.375)	Dia. A + .750	+0.005/-0.000	0.413	Dia. A + .002	+0.004/-0.000
10.000 - 19.999	+0.000/-0.003	1/2 (.500)	1/2 (.500)	Dia. A + 1.000	+0.007/-0.000	0.550	Dia. A + .002	+0.005/-0.000
20.000 - 29.999	+0.000/-0.003	5/8 (.625)	5/8 (.625)	Dia. A + 1.250	+0.009/-0.000	0.688	Dia. A + .002	+0.006/-0.000
30.000 - 39.999	+0.000/-0.004	3/4 (.750)	3/4 (.750)	Dia. A + 1.500	+0.011/-0.000	0.825	Dia. A + .002	+0.007/-0.000
40.000 +	+0.000/-0.005	1 (1.000)	1 (1.000)	Dia. A + 2.000	+0.015/-0.000	1.100	Dia. A + .002	+0.009/-0.000

* If used with wear rings, refer to wear ring throat diameter, see [Section 9](#).

Above table reflects recommended cross-sections for rod diameters shown. Alternate cross-sections and additional sizes may be considered. Consult www.parker.com/eps/FluidPower for additional cross-sections and sizes, hardware specifications, and part number availability. Contact your Parker representative for assistance.

Piston Gland Dimensions – SPP Profile, Standard PolyPak®

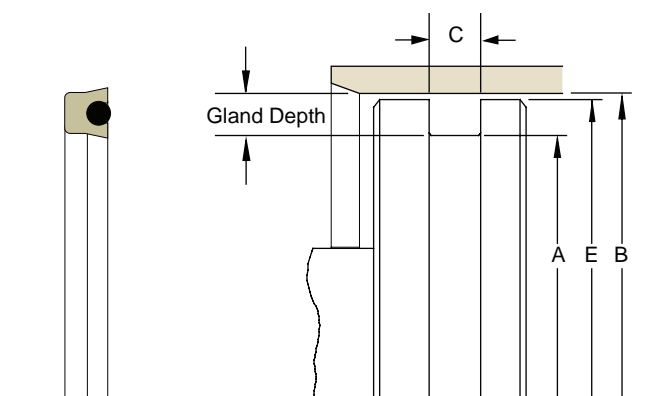

Please refer to Engineering [Section 2](#), [page 2-8](#) for surface finish and additional hardware considerations.

Table 6-7. SPP Profile – Piston Gland Calculation, Rubber and Polyurethane (90A)

B Bore Diameter		Seal		A Groove Diameter		C Groove Width	E Piston Diameter*	
Range	Tol.	Cross Section	Axial Width	Calculation	Tol.	+0.015/ -.000	Calculation	Tol.
0.312 - 1.499	+0.002/-0.000	1/8 (.125)	1/8 (.125)	Dia. B - .250	+0.000/-0.002	0.138	Dia. B - .001	+0.000/-0.001
1.500 - 2.999	+0.002/-0.000	3/16 (.187)	3/16 (.187)	Dia. B - .375	+0.000/-0.002	0.206	Dia. B - .001	+0.000/-0.002
3.000 - 5.999	+0.003/-0.000	1/4 (.250)	1/4 (.250)	Dia. B - .500	+0.000/-0.003	0.275	Dia. B - .001	+0.000/-0.002
6.000 - 9.999	+0.003/-0.000	5/16 (.312)	5/16 (.312)	Dia. B - .625	+0.000/-0.004	0.343	Dia. B - .002	+0.000/-0.002
10.000 - 19.999	+0.004/-0.000	3/8 (.375)	3/8 (.375)	Dia. B - .750	+0.000/-0.005	0.413	Dia. B - .002	+0.000/-0.002
20.000 - 29.999	+0.005/-0.000	1/2 (.500)	1/2 (.500)	Dia. B - 1.000	+0.000/-0.007	0.550	Dia. B - .002	+0.000/-0.003
30.000 - 39.999	+0.006/-0.000	5/8 (.625)	5/8 (.625)	Dia. B - 1.250	+0.000/-0.009	0.688	Dia. B - .002	+0.000/-0.003
40.000 - 49.999	+0.007/-0.000	3/4 (.750)	3/4 (.750)	Dia. B - 1.500	+0.000/-0.010	0.825	Dia. B - .002	+0.000/-0.004
50.000 +	+0.009/-0.000	1 (1.000)	1 (1.000)	Dia. B - 2.000	+0.000/-0.012	1.100	Dia. B - .002	+0.000/-0.005



Table 6-8. SPP Profile – Piston Gland Calculation, Polymyte (60D)

B Bore Diameter		Seal		A Groove Diameter		C Groove Width	E Piston Diameter*	
Range	Tol.	Cross Section	Axial Width	Calculation	Tol.	+0.015/ -.000	Calculation	Tol.
0.312 - 2.749	+0.002/-0.000	1/8 (.125)	1/8 (.125)	Dia. B - .250	+0.000/-0.002	0.138	Dia. B - .001	+0.000/-0.001
2.750 - 4.499	+0.002/-0.000	3/16 (.187)	3/16 (.187)	Dia. B - .375	+0.000/-0.002	0.206	Dia. B - .001	+0.000/-0.002
4.500 - 5.999	+0.003/-0.000	1/4 (.250)	1/4 (.250)	Dia. B - .500	+0.000/-0.003	0.275	Dia. B - .001	+0.000/-0.002
6.000 - 9.999	+0.003/-0.000	5/16 (.312)	5/16 (.312)	Dia. B - .625	+0.000/-0.004	0.343	Dia. B - .002	+0.000/-0.002
10.000 - 19.999	+0.004/-0.000	3/8 (.375)	3/8 (.375)	Dia. B - .750	+0.000/-0.005	0.413	Dia. B - .002	+0.000/-0.002
20.000 - 29.999	+0.005/-0.000	1/2 (.500)	1/2 (.500)	Dia. B - 1.000	+0.000/-0.007	0.550	Dia. B - .002	+0.000/-0.003
30.000 - 39.999	+0.006/-0.000	5/8 (.625)	5/8 (.625)	Dia. B - 1.250	+0.000/-0.009	0.688	Dia. B - .002	+0.000/-0.003
40.000 - 49.999	+0.007/-0.000	3/4 (.750)	3/4 (.750)	Dia. B - 1.500	+0.000/-0.010	0.825	Dia. B - .002	+0.000/-0.004
50.000 +	+0.009/-0.000	1 (1.000)	1 (1.000)	Dia. B - 2.000	+0.000/-0.012	1.100	Dia. B - .002	+0.000/-0.005

* If used with wear rings, refer to wear ring piston diameter, see [Section 9](#).

Above table reflects recommended cross-sections for bore diameters shown. Alternate cross-sections and additional sizes may be considered. Consult www.parker.com/eps/FluidPower for additional cross-sections and sizes, hardware specifications, and part number availability. Contact your Parker representative for assistance.

Symmetrical Seal DPP Profile, Deep PolyPak®

Catalog EPS 5370/USA

DPP Profile, Deep PolyPak®, O-ring Loaded Lip Seal with Scraper Lip Design



Parker's Deep PolyPak is a squeeze seal with a symmetrical profile for use in either rod or piston applications. Its rectangular shape ensures stability in the gland. The standard Molythane® shell provides high wear resistance and the o-ring energizer functions as a spring to maintain sealing contact under low pressure or vacuum applications. The Deep PolyPak straight cut scraper lip design cuts fluid film and moves contamination away from the seal. The sharp edge of the lip is formed by a precision knife trimming process. A wide selection of sizes and alternate compounds allow this profile to match up with many hydraulic applications. The Deep PolyPak is an economical choice as a stand alone rod or piston seal. Dual Deep PolyPak seals should not be installed back to back in bi-directional piston applications as a pressure trap between the seals may occur.

6

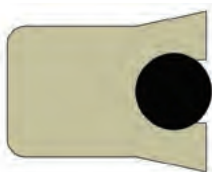

Deep PolyPak Cross-Section

Technical Data

Standard Materials*	Temperature Range	Pressure Range†	Surface Speed
Shell			
P4615A90	-65°F to +200°F (-54°C to +93°C)	5,000 psi (344 bar)	< 1.6 ft/s (0.5 m/s)
P4622A90	-65°F to +225°F (-54°C to +107°C)	5,000 psi (344 bar)	< 1.6 ft/s (0.5 m/s)
Z4651D60	-65°F to +275°F (-54°C to +135°C)	7,000 psi (482 bar)	< 1.6 ft/s (0.5 m/s)
N4263A90	-20°F to +275°F (-29°C to +135°C)	2,000 psi (138 bar)	< 1.6 ft/s (0.5 m/s)
E4207A90	-65°F to +300°F (-54°C to +149°C)	2,000 psi (138 bar)	< 1.6 ft/s (0.5 m/s)
V4208A90	-5°F to +400°F (-21°C to +204°C)	2,000 psi (138 bar)	< 1.6 ft/s (0.5 m/s)
V4266A95	-5°F to +400°F (-21°C to +204°C)	2,250 psi (155 bar)	< 1.6 ft/s (0.5 m/s)

Energizer

For Seals With...	Standard Energizer Material*
4615 or 4622 PolyPak shell	Standard energizer is a nitrile o-ring
4651 PolyPak shell	O-spring energizer code must be identified
Rubber PolyPak shell	Standard energizer is an o-ring from the same rubber material family as the shell

***Alternate Materials:** For custom energizer materials, see [Table 6-3 on page 6-5](#). For applications that may require an alternate shell material, please see [Section 3](#) or contact your local Parker Seal representative.

†**Pressure Range** without wear rings. If used with wear rings, see [Table 2-4, page 2-5](#).

06/01/2014

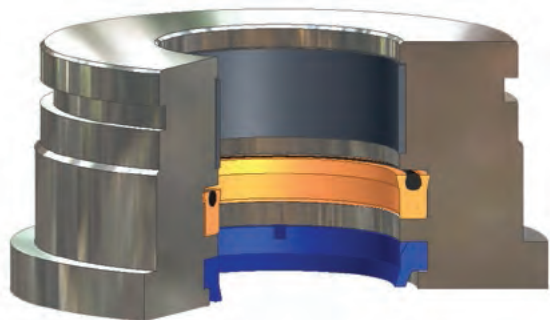

Deep PolyPak installed in Rod Gland

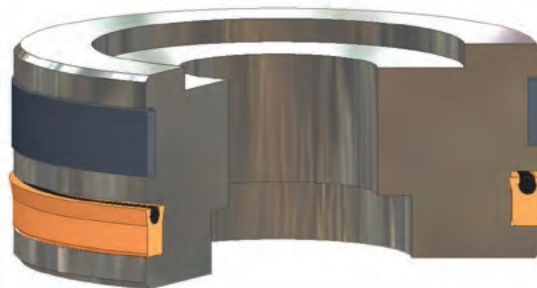

Deep PolyPak installed in Piston Gland

Part Number Nomenclature – DPP Profile, Deep PolyPak®

Table 6-9. DPP Profile, Deep PolyPak

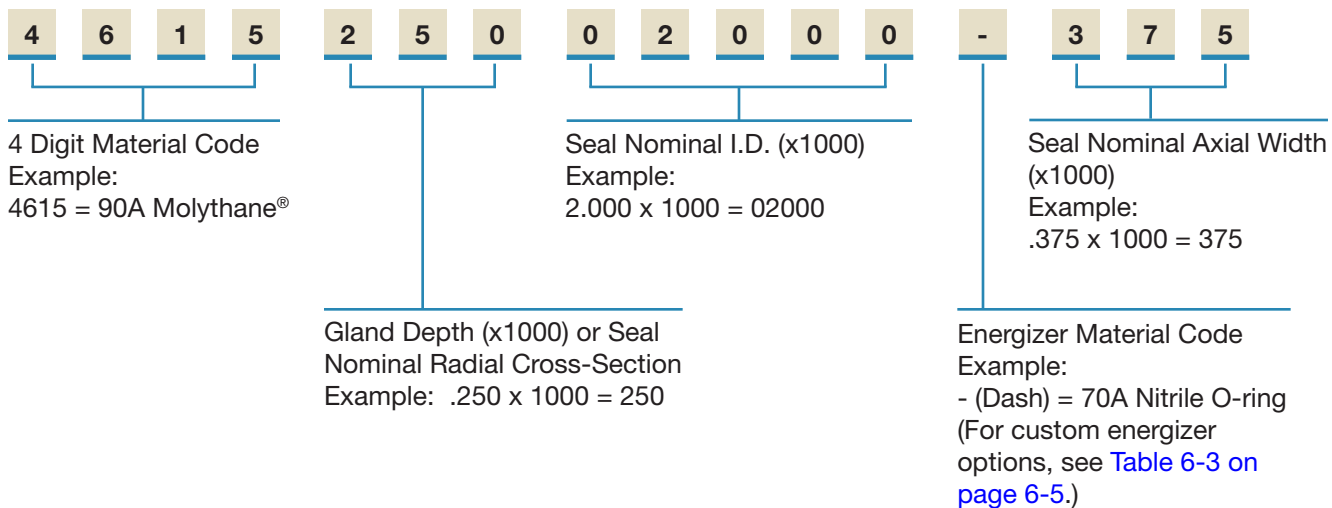

Rod Gland Dimensions – DPP Profile, Deep PolyPak®

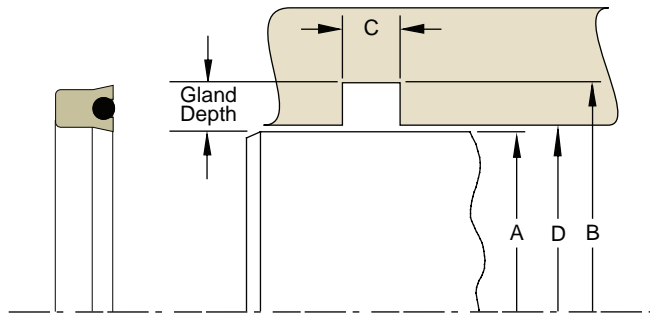

Please refer to Engineering [Section 2](#), [page 2-8](#) for surface finish and additional hardware considerations.

Table 6-10. DPP Profile – Rod Gland Calculation, Rubber and Polyurethane (90A)

A Rod Diameter		Seal		B Groove Diameter		C Groove Width	D Throat Diameter*	
Range	Tol.	Cross Section	Axial Width	Calculation	Tol.	+0.015/ -.000	Calculation	Tol.
0.062 - 0.624	+0.000/-0.001	1/8 (.125)	3/16 (.187)	Dia. A + .250	+0.002/-0.000	0.206	Dia. A + .001	+0.002/-0.000
0.625 - 0.999	+0.000/-0.001	1/8 (.125)	1/4 (.250)	Dia. A + .250	+0.002/-0.000	0.275	Dia. A + .001	+0.002/-0.000
1.000 - 1.499	+0.000/-0.002	3/16 (.187)	5/16 (.312)	Dia. A + .375	+0.002/-0.000	0.343	Dia. A + .001	+0.002/-0.000
1.500 - 1.999	+0.000/-0.002	3/16 (.187)	3/8 (.375)	Dia. A + .375	+0.002/-0.000	0.413	Dia. A + .001	+0.002/-0.000
2.000 - 3.499	+0.000/-0.002	1/4 (.250)	3/8 (.375)	Dia. A + .500	+0.003/-0.000	0.413	Dia. A + .001	+0.003/-0.000
3.500 - 4.999	+0.000/-0.002	5/16 (.312)	1/2 (.500)	Dia. A + .625	+0.004/-0.000	0.550	Dia. A + .002	+0.003/-0.000
5.000 - 9.999	+0.000/-0.002	3/8 (.375)	5/8 (.625)	Dia. A + .750	+0.005/-0.000	0.688	Dia. A + .002	+0.004/-0.000
10.000 - 19.999	+0.000/-0.003	1/2 (.500)	3/4 (.750)	Dia. A + 1.000	+0.007/-0.000	0.825	Dia. A + .002	+0.005/-0.000
20.000 - 29.999	+0.000/-0.003	5/8 (.625)	1 (1.000)	Dia. A + 1.250	+0.009/-0.000	1.100	Dia. A + .002	+0.006/-0.000
30.000 - 39.999	+0.000/-0.004	3/4 (.750)	1-1/4 (1.250)	Dia. A + 1.500	+0.011/-0.000	1.375	Dia. A + .002	+0.007/-0.000
40.000 +	+0.000/-0.005	1 (1.000)	1-1/2 (1.500)	Dia. A + 2.000	+0.015/-0.000	1.650	Dia. A + .002	+0.009/-0.000

Table 6-11. DPP Profile – Rod Gland Calculation, Polymyte (60D)

A Rod Diameter		Seal		B Groove Diameter		C Groove Width	D Throat Diameter*	
Range	Tol.	Cross Section	Axial Width	Calculation	Tol.	+0.015/ -.000	Calculation	Tol.
0.062 - 0.999	+0.000/-0.001	1/8 (.125)	3/16 (.187)	Dia. A + .250	+0.002/-0.000	0.206	Dia. A + .001	+0.002/-0.000
1.000 - 1.749	+0.000/-0.001	1/8 (.125)	1/4 (.250)	Dia. A + .250	+0.002/-0.000	0.275	Dia. A + .001	+0.002/-0.000
1.750 - 2.249	+0.000/-0.002	3/16 (.187)	5/16 (.312)	Dia. A + .375	+0.002/-0.000	0.343	Dia. A + .001	+0.002/-0.000
2.250 - 2.749	+0.000/-0.002	3/16 (.187)	3/8 (.375)	Dia. A + .375	+0.002/-0.000	0.413	Dia. A + .001	+0.002/-0.000
2.750 - 3.499	+0.000/-0.002	1/4 (.250)	3/8 (.375)	Dia. A + .500	+0.003/-0.000	0.413	Dia. A + .001	+0.003/-0.000
3.500 - 4.999	+0.000/-0.002	5/16 (.312)	1/2 (.500)	Dia. A + .625	+0.004/-0.000	0.550	Dia. A + .002	+0.003/-0.000
5.000 - 9.999	+0.000/-0.002	3/8 (.375)	5/8 (.625)	Dia. A + .750	+0.005/-0.000	0.688	Dia. A + .002	+0.004/-0.000
10.000 - 19.999	+0.000/-0.003	1/2 (.500)	3/4 (.750)	Dia. A + 1.000	+0.007/-0.000	0.825	Dia. A + .002	+0.005/-0.000
20.000 - 29.999	+0.000/-0.003	5/8 (.625)	1 (1.000)	Dia. A + 1.250	+0.009/-0.000	1.100	Dia. A + .002	+0.006/-0.000
30.000 - 39.999	+0.000/-0.004	3/4 (.750)	1-1/4 (1.250)	Dia. A + 1.500	+0.011/-0.000	1.375	Dia. A + .002	+0.007/-0.000
40.000 +	+0.000/-0.005	1 (1.000)	1-1/2 (1.500)	Dia. A + 2.000	+0.015/-0.000	1.650	Dia. A + .002	+0.009/-0.000

* If used with wear rings, refer to wear ring throat diameter, see [Section 9](#).

Above table reflects recommended cross-sections for rod diameters shown. Alternate cross-sections and additional sizes may be considered. Consult www.parker.com/eps/FluidPower for additional cross-sections and sizes, hardware specifications, and part number availability. Contact your Parker representative for assistance.

06/01/2014

Piston Gland Dimensions – DPP Profile, Deep PolyPak®

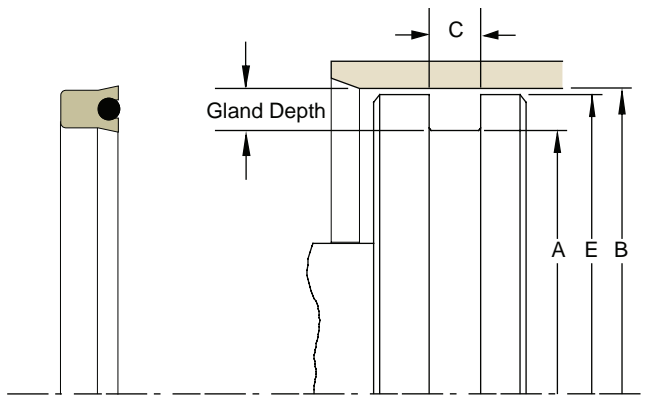

Please refer to Engineering [Section 2](#), [page 2-8](#) for surface finish and additional hardware considerations.

Table 6-12. DPP Profile – Piston Gland Calculation, Rubber and Polyurethane (90A)

B Bore Diameter		Seal		A Groove Diameter		C Groove Width	E Piston Diameter*	
Range	Tol.	Cross Section	Axial Width	Calculation	Tol.	+0.015/ -.000	Calculation	Tol.
0.312 - 1.499	+0.002/-0.000	1/8 (.125)	1/4 (.250)	Dia. B - .250	+0.000/-0.002	0.275	Dia. B - .001	+0.000/-0.001
1.500 - 2.999	+0.002/-0.000	3/16 (.187)	5/16 (.312)	Dia. B - .375	+0.000/-0.002	0.343	Dia. B - .001	+0.000/-0.002
3.000 - 5.999	+0.003/-0.000	1/4 (.250)	3/8 (.375)	Dia. B - .500	+0.000/-0.003	0.413	Dia. B - .001	+0.000/-0.002
6.000 - 9.999	+0.003/-0.000	5/16 (.312)	1/2 (.500)	Dia. B - .625	+0.000/-0.004	0.550	Dia. B - .002	+0.000/-0.002
10.000 - 19.999	+0.004/-0.000	3/8 (.375)	5/8 (.625)	Dia. B - .750	+0.000/-0.005	0.688	Dia. B - .002	+0.000/-0.002
20.000 - 29.999	+0.005/-0.000	1/2 (.500)	3/4 (.750)	Dia. B - 1.000	+0.000/-0.007	0.825	Dia. B - .002	+0.000/-0.003
30.000 - 39.999	+0.006/-0.000	5/8 (.625)	1 (1.000)	Dia. B - 1.250	+0.000/-0.009	1.100	Dia. B - .002	+0.000/-0.003
40.000 - 49.999	+0.007/-0.000	3/4 (.750)	1-1/4 (1.250)	Dia. B - 1.500	+0.000/-0.010	1.375	Dia. B - .002	+0.000/-0.004
50.000 +	+0.009/-0.000	1 (1.000)	1-1/2 (1.500)	Dia. B - 2.000	+0.000/-0.012	1.650	Dia. B - .002	+0.000/-0.005

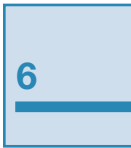

Table 6-13. DPP Profile – Piston Gland Calculation, Polymyte (60D)

B Bore Diameter		Seal		A Groove Diameter		C Groove Width	E Piston Diameter*	
Range	Tol.	Cross Section	Axial Width	Calculation	Tol.	+0.015/ -.000	Calculation	Tol.
0.312 - 2.749	+0.002/-0.000	1/8 (.125)	1/4 (.250)	Dia. B - .250	+0.000/-0.002	0.275	Dia. B - .001	+0.000/-0.001
2.750 - 4.499	+0.002/-0.000	3/16 (.187)	5/16 (.312)	Dia. B - .375	+0.000/-0.002	0.343	Dia. B - .001	+0.000/-0.002
4.500 - 5.999	+0.003/-0.000	1/4 (.250)	3/8 (.375)	Dia. B - .500	+0.000/-0.003	0.413	Dia. B - .001	+0.000/-0.002
6.000 - 9.999	+0.003/-0.000	5/16 (.312)	1/2 (.500)	Dia. B - .625	+0.000/-0.004	0.550	Dia. B - .002	+0.000/-0.002
10.000 - 19.999	+0.004/-0.000	3/8 (.375)	5/8 (.625)	Dia. B - .750	+0.000/-0.005	0.688	Dia. B - .002	+0.000/-0.002
20.000 - 29.999	+0.005/-0.000	1/2 (.500)	3/4 (.750)	Dia. B - 1.000	+0.000/-0.007	0.825	Dia. B - .002	+0.000/-0.003
30.000 - 39.999	+0.006/-0.000	5/8 (.625)	1 (1.000)	Dia. B - 1.250	+0.000/-0.009	1.100	Dia. B - .002	+0.000/-0.003
40.000 - 49.999	+0.007/-0.000	3/4 (.750)	1-1/4 (1.250)	Dia. B - 1.500	+0.000/-0.010	1.375	Dia. B - .002	+0.000/-0.004
50.000 +	+0.009/-0.000	1 (1.000)	1-1/2 (1.500)	Dia. B - 2.000	+0.000/-0.012	1.650	Dia. B - .002	+0.000/-0.005

* If used with wear rings, refer to wear ring bore diameter, see [Section 9](#).

Above table reflects recommended cross-sections for piston diameters shown. Alternate cross-sections and additional sizes may be considered. Consult www.parker.com/eps/FluidPower for additional cross-sections and sizes, hardware specifications, and part number availability. Contact your Parker representative for assistance.

Symmetrical Seal BPP Profile, Type B PolyPak®

Catalog EPS 5370/USA

BPP Profile, Type B PolyPak® O-ring Energized Lip Seal with Beveled Lip Design



Parker's BPP profile, Type B PolyPak is a squeeze seal with a symmetrical profile for use in either rod or piston applications. The rectangular shape of its cross section ensures stability in the gland. The standard Molythane® shell provides high wear resistance and the o-ring energizer functions as a spring to maintain sealing contact under low pressure or vacuum applications. The beveled lip design of the seal is excellent for cutting fluid film and is formed by a precision knife trimming process. A wide selection of sizes and alternate compounds allow this profile to match up with many hydraulic applications. The Type B PolyPak is an economical choice as a stand-alone seal or can be used in tandem with a buffer seal. In piston applications, this seal will function as a unidirectional seal. Dual Type B PolyPak seals should not be installed back-to-back in bi-directional pressure applications, as a pressure trap between the seals may occur. Instead, for bi-directional piston sealing, incorporate a PIP Ring® (see [page 7-15](#)).

6



Type B PolyPak
Cross-Section

Technical Data

Standard Materials*	Temperature Range	Pressure Range†	Surface Speed
Shell			
P4615A90	-65°F to +200°F (-54°C to +93°C)	5,000 psi (344 bar)	< 1.6 ft/s (0.5 m/s)
P4622A90	-65°F to +225°F (-54°C to +107°C)	5,000 psi (344 bar)	< 1.6 ft/s (0.5 m/s)
Z4651D60	-65°F to +275°F (-54°C to +135°C)	7,000 psi (482 bar)	< 1.6 ft/s (0.5 m/s)
N4263A90	-20°F to +275°F (-29°C to +135°C)	2,000 psi (138 bar)	< 1.6 ft/s (0.5 m/s)
E4207A90	-65°F to +300°F (-54°C to +149°C)	2,000 psi (138 bar)	< 1.6 ft/s (0.5 m/s)
V4208A90	-5°F to +400°F (-21°C to +204°C)	2,000 psi (138 bar)	< 1.6 ft/s (0.5 m/s)
V4266A95	-5°F to +400°F (-21°C to +204°C)	2,250 psi (155 bar)	< 1.6 ft/s (0.5 m/s)

Energizer

For Seals With...	Standard Energizer Material*
4615 or 4622 PolyPak shell	Standard energizer is a nitrile o-ring
4651 PolyPak shell	O-spring energizer code must be identified
Rubber PolyPak shell	Standard energizer is an o-ring from the same rubber material family as the shell

***Alternate Materials:** For custom energizer materials, see [Table 6-3 on page 6-5](#). For applications that may require an alternate shell material, please see [Section 3](#) or contact your local Parker seal representative.

†Pressure Range without wear rings. If used with wear rings, see [Table 2-4, page 2-5](#).

06/01/2014

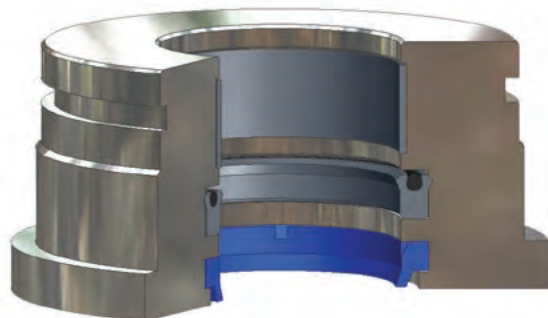

Type B PolyPak installed in Rod Gland

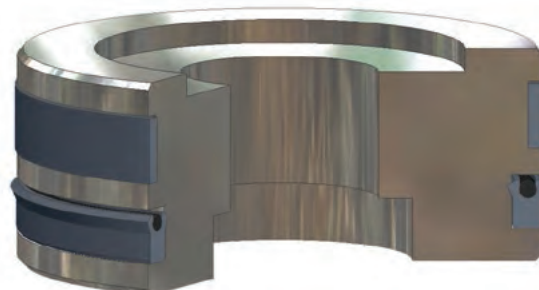

Type B PolyPak installed in Piston Gland

Part Number Nomenclature – BPP Profile, Type B PolyPak®

Table 6-14. BPP Profile

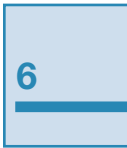
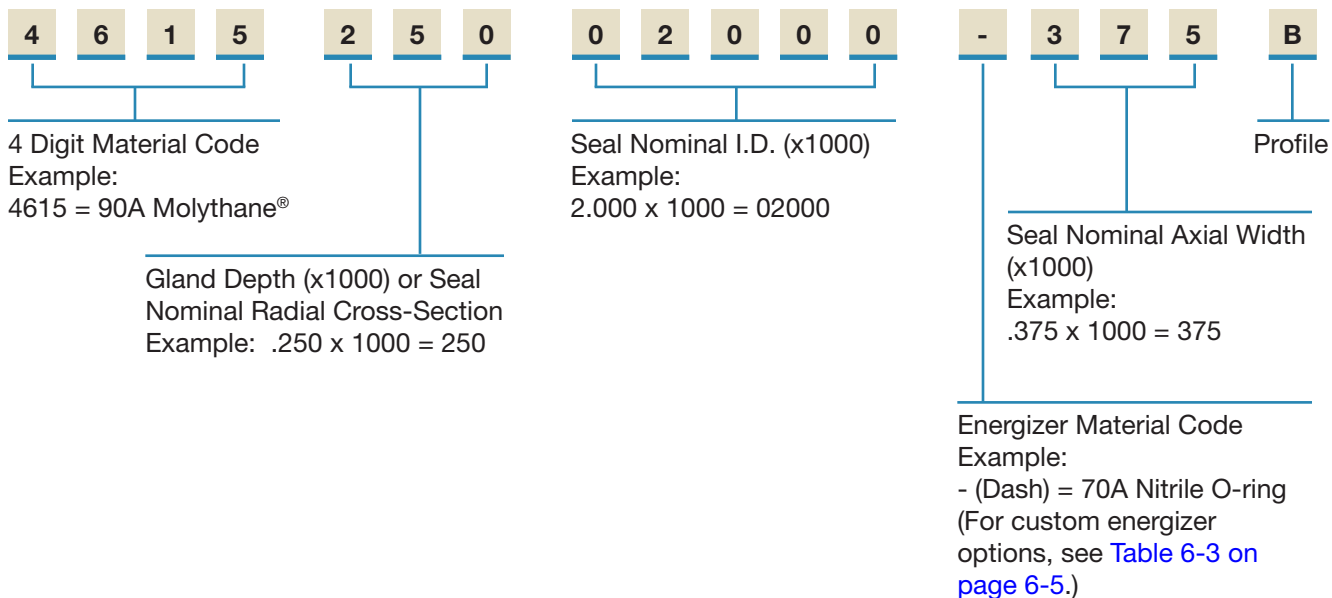

Rod Gland Dimensions — BPP Profile, Type B PolyPak®

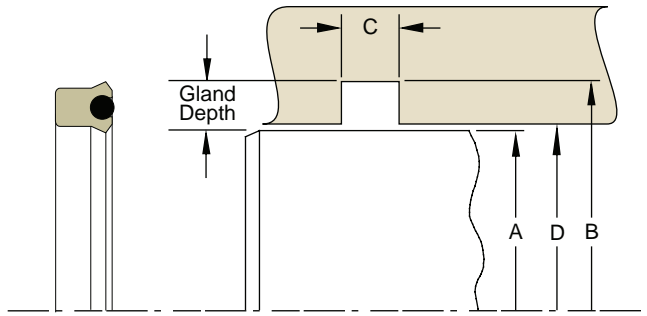

Please refer to Engineering [Section 2](#), [page 2-8](#) for surface finish and additional hardware considerations.

Table 6-15. BPP Profile — Rod Gland Calculation, Rubber and Polyurethane (90A)

A Rod Diameter		Seal		B Groove Diameter		C Groove Width	D Throat Diameter*	
Range	Tol.	Cross Section	Axial Width	Calculation	Tol.	+0.015/ -.000	Calculation	Tol.
0.062 - 0.624	+0.000/-0.001	1/8 (.125)	3/16 (.187)	Dia. A + .250	+0.002/-0.000	0.206	Dia. A + .001	+0.002/-0.000
0.625 - 0.999	+0.000/-0.001	1/8 (.125)	1/4 (.250)	Dia. A + .250	+0.002/-0.000	0.275	Dia. A + .001	+0.002/-0.000
1.000 - 1.499	+0.000/-0.002	3/16 (.187)	5/16 (.312)	Dia. A + .375	+0.002/-0.000	0.343	Dia. A + .001	+0.002/-0.000
1.500 - 1.999	+0.000/-0.002	3/16 (.187)	3/8 (.375)	Dia. A + .375	+0.002/-0.000	0.413	Dia. A + .001	+0.002/-0.000
2.000 - 3.499	+0.000/-0.002	1/4 (.250)	3/8 (.375)	Dia. A + .500	+0.003/-0.000	0.413	Dia. A + .001	+0.003/-0.000
3.500 - 4.999	+0.000/-0.002	5/16 (.312)	1/2 (.500)	Dia. A + .625	+0.004/-0.000	0.550	Dia. A + .002	+0.003/-0.000
5.000 - 9.999	+0.000/-0.002	3/8 (.375)	5/8 (.625)	Dia. A + .750	+0.005/-0.000	0.688	Dia. A + .002	+0.004/-0.000
10.000 - 19.999	+0.000/-0.003	1/2 (.500)	3/4 (.750)	Dia. A + 1.000	+0.007/-0.000	0.825	Dia. A + .002	+0.005/-0.000
20.000 - 29.999	+0.000/-0.003	5/8 (.625)	1 (1.000)	Dia. A + 1.250	+0.009/-0.000	1.100	Dia. A + .002	+0.006/-0.000
30.000 - 39.999	+0.000/-0.004	3/4 (.750)	1-1/4 (1.250)	Dia. A + 1.500	+0.011/-0.000	1.375	Dia. A + .002	+0.007/-0.000
40.000 +	+0.000/-0.005	1 (1.000)	1-1/2 (1.500)	Dia. A + 2.000	+0.015/-0.000	1.650	Dia. A + .002	+0.009/-0.000

Table 6-16. BPP Profile — Rod Gland Calculation, Polymyte (60D)

A Rod Diameter		Seal		B Groove Diameter		C Groove Width	D Throat Diameter*	
Range	Tol.	Cross Section	Axial Width	Calculation	Tol.	+0.015/ -.000	Calculation	Tol.
0.062 - 0.999	+0.000/-0.001	1/8 (.125)	3/16 (.187)	Dia. A + .250	+0.002/-0.000	0.206	Dia. A + .001	+0.002/-0.000
1.000 - 1.749	+0.000/-0.001	1/8 (.125)	1/4 (.250)	Dia. A + .250	+0.002/-0.000	0.275	Dia. A + .001	+0.002/-0.000
1.750 - 2.249	+0.000/-0.002	3/16 (.187)	5/16 (.312)	Dia. A + .375	+0.002/-0.000	0.343	Dia. A + .001	+0.002/-0.000
2.250 - 2.749	+0.000/-0.002	3/16 (.187)	3/8 (.375)	Dia. A + .375	+0.002/-0.000	0.413	Dia. A + .001	+0.002/-0.000
2.750 - 3.499	+0.000/-0.002	1/4 (.250)	3/8 (.375)	Dia. A + .500	+0.003/-0.000	0.413	Dia. A + .001	+0.003/-0.000
3.500 - 4.999	+0.000/-0.002	5/16 (.312)	1/2 (.500)	Dia. A + .625	+0.004/-0.000	0.550	Dia. A + .002	+0.003/-0.000
5.000 - 9.999	+0.000/-0.002	3/8 (.375)	5/8 (.625)	Dia. A + .750	+0.005/-0.000	0.688	Dia. A + .002	+0.004/-0.000
10.000 - 19.999	+0.000/-0.003	1/2 (.500)	3/4 (.750)	Dia. A + 1.000	+0.007/-0.000	0.825	Dia. A + .002	+0.005/-0.000
20.000 - 29.999	+0.000/-0.003	5/8 (.625)	1 (1.000)	Dia. A + 1.250	+0.009/-0.000	1.100	Dia. A + .002	+0.006/-0.000
30.000 - 39.999	+0.000/-0.004	3/4 (.750)	1-1/4 (1.250)	Dia. A + 1.500	+0.011/-0.000	1.375	Dia. A + .002	+0.007/-0.000
40.000 +	+0.000/-0.005	1 (1.000)	1-1/2 (1.500)	Dia. A + 2.000	+0.015/-0.000	1.650	Dia. A + .002	+0.009/-0.000

* If used with wear rings, refer to wear ring throat diameter, see [Section 9](#).

Above table reflects recommended cross-sections for rod diameters shown. Alternate cross-sections and additional sizes may be considered. Consult www.parker.com/eps/FluidPower for additional cross-sections and sizes, hardware specifications, and part number availability. Contact your Parker representative for assistance.

Piston Gland Dimensions – BPP Profile, Type B PolyPak®

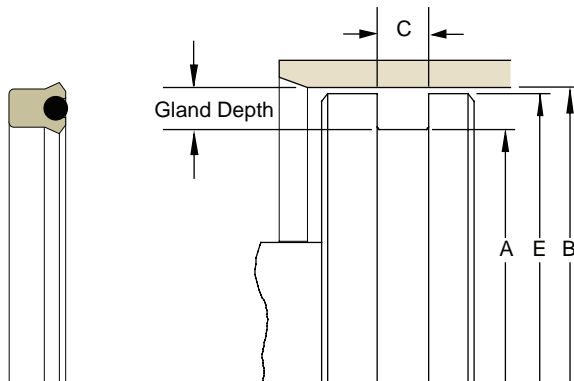

Please refer to Engineering [Section 2](#), [page 2-8](#) for surface finish and additional hardware considerations.

Table 6-17. BPP Profile – Piston Gland Calculation, Rubber and Polyurethane (90A)

B Bore Diameter		Seal		A Groove Diameter		C Groove Width	E Piston Diameter*	
Range	Tol.	Cross Section	Axial Width	Calculation	Tol.	+0.015/ -.000	Calculation	Tol.
0.312 - 1.499	+0.002/-0.000	1/8 (.125)	1/4 (.250)	Dia. B - .250	+0.000/-0.002	0.275	Dia. B - .001	+0.000/-0.001
1.500 - 2.999	+0.002/-0.000	3/16 (.187)	5/16 (.312)	Dia. B - .375	+0.000/-0.002	0.343	Dia. B - .001	+0.000/-0.002
3.000 - 5.999	+0.003/-0.000	1/4 (.250)	3/8 (.375)	Dia. B - .500	+0.000/-0.003	0.413	Dia. B - .001	+0.000/-0.002
6.000 - 9.999	+0.003/-0.000	5/16 (.312)	1/2 (.500)	Dia. B - .625	+0.000/-0.004	0.550	Dia. B - .002	+0.000/-0.002
10.000 - 19.999	+0.004/-0.000	3/8 (.375)	5/8 (.625)	Dia. B - .750	+0.000/-0.005	0.688	Dia. B - .002	+0.000/-0.002
20.000 - 29.999	+0.005/-0.000	1/2 (.500)	3/4 (.750)	Dia. B - 1.000	+0.000/-0.007	0.825	Dia. B - .002	+0.000/-0.003
30.000 - 39.999	+0.006/-0.000	5/8 (.625)	1 (1.000)	Dia. B - 1.250	+0.000/-0.009	1.100	Dia. B - .002	+0.000/-0.003
40.000 - 49.999	+0.007/-0.000	3/4 (.750)	1-1/4 (1.250)	Dia. B - 1.500	+0.000/-0.010	1.375	Dia. B - .002	+0.000/-0.004
50.000 +	+0.009/-0.000	1 (1.000)	1-1/2 (1.500)	Dia. B - 2.000	+0.000/-0.012	1.650	Dia. B - .002	+0.000/-0.005

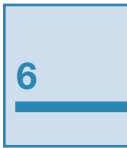

Table 6-18. BPP Profile – Piston Gland Calculation, Polymyte (60D)

B Bore Diameter		Seal		A Groove Diameter		C Groove Width	E Piston Diameter*	
Range	Tol.	Cross Section	Axial Width	Calculation	Tol.	+0.015/ -.000	Calculation	Tol.
0.312 - 2.749	+0.002/-0.000	1/8 (.125)	1/4 (.250)	Dia. B - .250	+0.000/-0.002	0.275	Dia. B - .001	+0.000/-0.001
2.750 - 4.499	+0.002/-0.000	3/16 (.187)	5/16 (.312)	Dia. B - .375	+0.000/-0.002	0.343	Dia. B - .001	+0.000/-0.002
4.500 - 5.999	+0.003/-0.000	1/4 (.250)	3/8 (.375)	Dia. B - .500	+0.000/-0.003	0.413	Dia. B - .001	+0.000/-0.002
6.000 - 9.999	+0.003/-0.000	5/16 (.312)	1/2 (.500)	Dia. B - .625	+0.000/-0.004	0.550	Dia. B - .002	+0.000/-0.002
10.000 - 19.999	+0.004/-0.000	3/8 (.375)	5/8 (.625)	Dia. B - .750	+0.000/-0.005	0.688	Dia. B - .002	+0.000/-0.002
20.000 - 29.999	+0.005/-0.000	1/2 (.500)	3/4 (.750)	Dia. B - 1.000	+0.000/-0.007	0.825	Dia. B - .002	+0.000/-0.003
30.000 - 39.999	+0.006/-0.000	5/8 (.625)	1 (1.000)	Dia. B - 1.250	+0.000/-0.009	1.100	Dia. B - .002	+0.000/-0.003
40.000 - 49.999	+0.007/-0.000	3/4 (.750)	1-1/4 (1.250)	Dia. B - 1.500	+0.000/-0.010	1.375	Dia. B - .002	+0.000/-0.004
50.000+	+0.009/-0.000	1 (1.000)	1-1/2 (1.500)	Dia. B - 2.000	+0.000/-0.012	1.650	Dia. B - .002	+0.000/-0.005

* If used with wear rings, refer to wear ring bore diameter, see [Section 9](#).

Above table reflects recommended cross-sections for piston diameters shown. Alternate cross-sections and additional sizes may be considered. Consult www.parker.com/eps/FluidPower for additional cross-sections and sizes, hardware specifications, and part number availability. Contact your Parker representative for assistance.

Symmetrical Seals

8400 & 8500 U-cup ♦ Preferred Profile

Catalog EPS 5370/USA

8400 Profile, Light Load U-cup with Beveled Lips; 8500 Profile, Light Load U-cup with Scraper Lips



Parker's 8400 and 8500 Series u-cups are symmetrical lip seals for use in either rod or piston sealing applications. The thin, flexible lip design reacts to low pressure and provides an extremely smooth, steady movement with less break away force required because of the inherent low friction. Both the 8400 and 8500 u-cups are produced from the same molds. The 8400 style utilizes a beveled lip, ideal for wiping fluid film, while the 8500 design utilizes a straight cut scraper lip that yields additional lip interference and wipes contamination away from the sealing edge. Both u-cup profiles are available in a variety of rubber compounds to cover a wide range of applications. While the 8400 and 8500 u-cups are primarily designed for pneumatic applications, they can also be used in low to medium pressure hydraulic applications. The pressure range of the u-cups may be extended by incorporating an 8700 back-up ring.

6



8400 Cross-Section



8500 Cross-Section

Technical Data

Parker Standard Material*	Temperature Range	Pressure Range†		Surface Speed**
		Hydr.	Pneu.	
N4180A80	-40°F to +250°F (-40°C to +121°C)	1,250 psi (86 bar)	250 psi (17 bar)	< 1.6 ft/s (0.5 m/s)
Additional Materials				
N4274A85	-10°F to +250°F (-23°C to +121°C)	1,750 psi (120 bar)	250 psi (17 bar)	< 1.6 ft/s (0.5 m/s)
V4208A90	-5°F to +400°F (-21°C to +204°C)	2,000 psi (138 bar)	250 psi (17 bar)	< 1.6 ft/s (0.5 m/s)
E4259A80	-65°F to +300°F (-54°C to +149°C)	1,250 psi (86 bar)	250 psi (17 bar)	< 1.6 ft/s (0.5 m/s)

*Alternate Materials: For applications that may require an alternate material, please contact your local Parker seal representative.

†Pressure Range without wear rings. If used with wear rings, see [Table 2-4, page 2-5](#).

**Surface Speed for pneumatic applications < 3.3 ft/s (1.0 m/s).

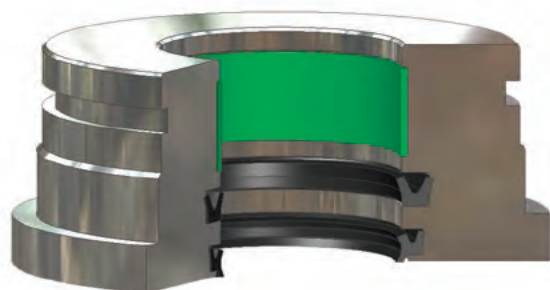

8400 installed in Rod Gland

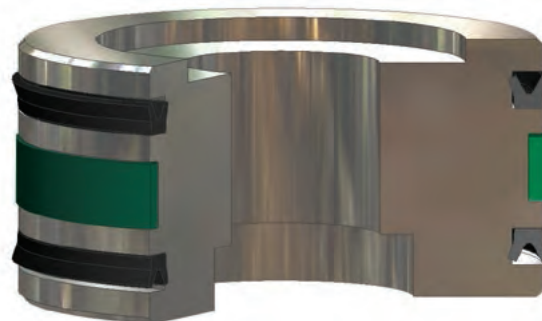

8400 installed in Piston Gland

06/01/2014

Part Number Nomenclature — 8400 and 8500 Profiles

Table 6-19. 8400 and 8500 Profile

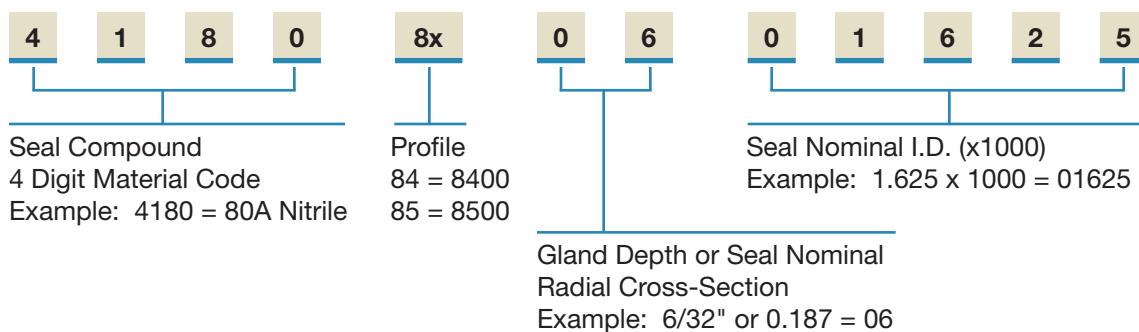

Rod Gland Calculations — 8400 and 8500 Profiles

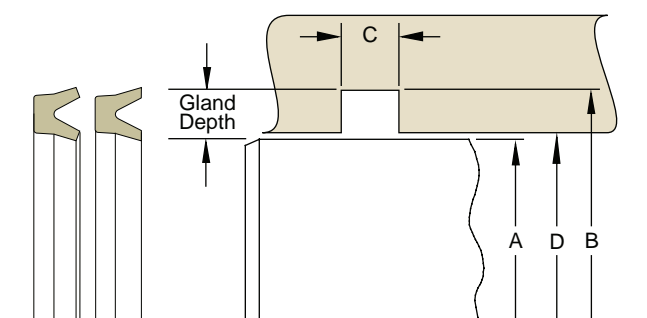

Please refer to Engineering [Section 2](#), [page 2-8](#) for surface finish and additional hardware considerations.

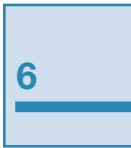

Table 6-20. 8400 and 8500 Profiles — Rod Gland Calculation

A Rod Diameter		Seal	B Groove Diameter		C Groove Width	D Throat Diameter*	
Range	Tol.	Cross Section	Calculation	Tol.	+0.015/-.000	Calculation	Tol.
0.125 - 0.249	+0.000/-.002	02/32 (.062)	Dia. A + .125	+0.002/-.000	0.093	Dia. A + .001	+0.002/-.000
0.250 - 0.374	+0.000/-.002	03/32 (.094)	Dia. A + .187	+0.002/-.000	0.125	Dia. A + .001	+0.002/-.000
0.375 - 1.124	+0.000/-.002	04/32 (.125)	Dia. A + .250	+0.002/-.000	0.156	Dia. A + .001	+0.002/-.000
1.125 - 1.624	+0.000/-.002	05/32 (.156)	Dia. A + .312	+0.002/-.000	0.188	Dia. A + .001	+0.002/-.000
1.625 - 3.249	+0.000/-.002	06/32 (.187)	Dia. A + .375	+0.002/-.000	0.218	Dia. A + .001	+0.002/-.000
3.250 - 4.999	+0.000/-.003	08/32 (.250)	Dia. A + .500	+0.003/-.000	0.281	Dia. A + .002	+0.003/-.000
5.000 - 5.499	+0.000/-.003	09/32 (.281)	Dia. A + .562	+0.003/-.000	0.312	Dia. A + .002	+0.003/-.000
5.500 - 8.999	+0.000/-.003	10/32 (.312)	Dia. A + .625	+0.004/-.000	0.344	Dia. A + .002	+0.003/-.000
9.000 +	+0.000/-.004	12/32 (.375)	Dia. A + .750	+0.005/-.000	0.406	Dia. A + .002	+0.004/-.000

* If used with wear rings, refer to wear ring throat diameter, see [Section 9](#).

Above table reflects recommended cross-sections for rod diameters shown. Alternate cross-sections and additional sizes may be considered. Consult www.parker.com/eps/FluidPower for additional cross-sections and sizes, hardware specifications, and part number availability. Contact your Parker representative for assistance.

Table 6-21. 8400 and 8500 Profiles — Rod Gland Dimensions, †Parker Standard Sizes

A Rod Diameter		B Groove Diameter		C Groove Width	D Throat Diameter*		Part Number (Replace "8x" with appropriate Profile Code)
Dia	Tol.	Dia	Tol.	+0.015/ -0.000	Dia	Tol.	
0.125	+0.000/-0.001	0.250	+0.002/-0.000	0.093	0.126	+0.002/-0.000	41808x0200125
0.187	+0.000/-0.001	0.312	+0.002/-0.000	0.093	0.188	+0.002/-0.000	41808x0200187
0.250	+0.000/-0.001	0.437	+0.002/-0.000	0.125	0.251	+0.002/-0.000	41808x0300250
0.312	+0.000/-0.001	0.500	+0.002/-0.000	0.125	0.313	+0.002/-0.000	41808x0300312
0.375	+0.000/-0.001	0.625	+0.002/-0.000	0.156	0.376	+0.002/-0.000	41808x0400375
0.437	+0.000/-0.001	0.687	+0.002/-0.000	0.156	0.438	+0.002/-0.000	41808x0400437
0.500	+0.000/-0.001	0.750	+0.002/-0.000	0.156	0.501	+0.002/-0.000	41808x0400500
0.625	+0.000/-0.001	0.875	+0.002/-0.000	0.156	0.626	+0.002/-0.000	41808x0400625
0.750	+0.000/-0.001	1.000	+0.002/-0.000	0.156	0.751	+0.002/-0.000	41808x0400750
0.875	+0.000/-0.001	1.125	+0.002/-0.000	0.156	0.876	+0.002/-0.000	41808x0400875
1.000	+0.000/-0.001	1.250	+0.002/-0.000	0.156	1.001	+0.002/-0.000	41808x0401000
1.125	+0.000/-0.001	1.437	+0.002/-0.000	0.188	1.126	+0.002/-0.000	41808x0501125
1.250	+0.000/-0.001	1.562	+0.002/-0.000	0.188	1.251	+0.002/-0.000	41808x0501250
1.375	+0.000/-0.001	1.687	+0.002/-0.000	0.188	1.376	+0.002/-0.000	41808x0501375
1.500	+0.000/-0.001	1.812	+0.002/-0.000	0.188	1.501	+0.002/-0.000	41808x0501500
1.625	+0.000/-0.002	2.000	+0.002/-0.000	0.218	1.626	+0.002/-0.000	41808x0601625
1.750	+0.000/-0.002	2.125	+0.002/-0.000	0.218	1.751	+0.002/-0.000	41808x0601750
1.875	+0.000/-0.002	2.250	+0.002/-0.000	0.218	1.876	+0.002/-0.000	41808x0601875
2.000	+0.000/-0.002	2.375	+0.002/-0.000	0.218	2.001	+0.002/-0.000	41808x0602000
2.125	+0.000/-0.002	2.500	+0.002/-0.000	0.218	2.126	+0.002/-0.000	41808x0602125
2.250	+0.000/-0.002	2.625	+0.002/-0.000	0.218	2.251	+0.002/-0.000	41808x0602250
2.375	+0.000/-0.002	2.750	+0.002/-0.000	0.218	2.376	+0.002/-0.000	41808x0602375
2.500	+0.000/-0.002	2.875	+0.002/-0.000	0.218	2.501	+0.002/-0.000	41808x0602500
2.625	+0.000/-0.002	3.000	+0.002/-0.000	0.218	2.626	+0.002/-0.000	41808x0602625
2.750	+0.000/-0.002	3.125	+0.002/-0.000	0.218	2.751	+0.002/-0.000	41808x0602750
3.000	+0.000/-0.002	3.375	+0.002/-0.000	0.218	3.001	+0.002/-0.000	41808x0603000
3.250	+0.000/-0.002	3.750	+0.003/-0.000	0.281	3.252	+0.003/-0.000	41808x0803250
3.500	+0.000/-0.002	4.000	+0.003/-0.000	0.281	3.502	+0.003/-0.000	41808x0803500
3.750	+0.000/-0.002	4.250	+0.003/-0.000	0.281	3.752	+0.003/-0.000	41808x0803750
4.000	+0.000/-0.002	4.500	+0.003/-0.000	0.281	4.002	+0.003/-0.000	41808x0804000
4.250	+0.000/-0.002	4.750	+0.003/-0.000	0.281	4.252	+0.003/-0.000	41808x0804250
4.500	+0.000/-0.002	5.000	+0.003/-0.000	0.281	4.502	+0.003/-0.000	41808x0804500
4.750	+0.000/-0.002	5.250	+0.003/-0.000	0.281	4.752	+0.003/-0.000	41808x0804750
5.000	+0.000/-0.002	5.562	+0.003/-0.000	0.312	5.002	+0.003/-0.000	41808x0905000
5.500	+0.000/-0.002	6.125	+0.004/-0.000	0.344	5.502	+0.003/-0.000	41808x1005500
6.000	+0.000/-0.002	6.625	+0.004/-0.000	0.344	6.002	+0.003/-0.000	41808x1006000
6.500	+0.000/-0.002	7.125	+0.004/-0.000	0.344	6.502	+0.003/-0.000	41808x1006500
7.000	+0.000/-0.002	7.625	+0.004/-0.000	0.344	7.002	+0.003/-0.000	41808x1007000

* If used with wear rings, refer to wear ring throat diameter, see Section 9.

Above table reflects recommended cross-sections for rod diameters shown. Alternate cross-sections and additional sizes may be considered. Consult www.parker.com/eps/FluidPower for additional cross-sections and sizes, hardware specifications, and part number availability. Contact your Parker representative for assistance.

Table 6-21. 8400 and 8500 Profiles – Rod Gland Dimensions, ♦Parker Standard Sizes (cont'd)

A Rod Diameter		B Groove Diameter		C Groove Width	D Throat Diameter*		Part Number (Replace "8x" with appropriate Profile Code)
Dia	Tol.	Dia	Tol.	+0.015/ -.000	Dia	Tol.	
7.500	+0.000/-0.002	8.125	+0.004/-0.000	0.344	7.502	+0.003/-0.000	41808x1007500
8.000	+0.000/-0.002	8.625	+0.004/-0.000	0.344	8.002	+0.003/-0.000	41808x1008000
8.500	+0.000/-0.002	9.125	+0.004/-0.000	0.344	8.502	+0.003/-0.000	41808x1008500
9.000	+0.000/-0.002	9.750	+0.005/-0.000	0.406	9.002	+0.004/-0.000	41808x1209000
9.500	+0.000/-0.002	10.250	+0.005/-0.000	0.406	9.502	+0.004/-0.000	41808x1209500
10.000	+0.000/-0.002	10.750	+0.005/-0.000	0.406	10.002	+0.004/-0.000	41808x1210000

* If used with wear rings, refer to wear ring throat diameter, see [Section 9](#).

Above table reflects recommended cross-sections for rod diameters shown. Alternate cross-sections and additional sizes may be considered. Consult www.parker.com/eps/FluidPower for additional cross-sections and sizes, hardware specifications, and part number availability. Contact your Parker representative for assistance.

Piston Gland Calculations – 8400 and 8500 Profiles

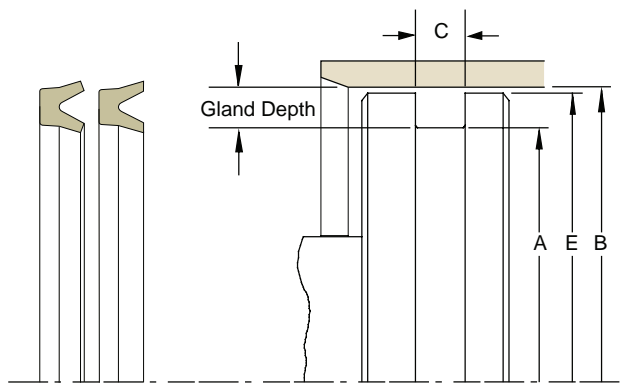

Please refer to Engineering [Section 2](#), [page 2-8](#) for surface finish and additional hardware considerations.



Table 6-22. 8400 and 8500 Profiles – Piston Gland Calculation

B Bore Diameter		Seal Cross Section	A Groove Diameter		C Groove Width +0.015/ -.000	E Piston Diameter*	
Range	Tol.		Calculation	Tol.		Calculation	Tol.
0.250 - 0.436	+0.002/-0.000	2/32 (.062)	Dia. B - .125	+0.000/-0.002	0.093	Dia. B - .001	+0.000/-0.001
0.437 - 0.624	+0.002/-0.000	3/32 (.094)	Dia. B - .187	+0.000/-0.002	0.125	Dia. B - .001	+0.000/-0.001
0.625 - 1.374	+0.002/-0.000	4/32 (.125)	Dia. B - .250	+0.000/-0.002	0.156	Dia. B - .001	+0.000/-0.001
1.375 - 1.749	+0.002/-0.000	5/32 (.156)	Dia. B - .312	+0.000/-0.002	0.188	Dia. B - .001	+0.000/-0.001
1.750 - 2.999	+0.002/-0.000	6/32 (.187)	Dia. B - .375	+0.000/-0.002	0.218	Dia. B - .001	+0.000/-0.002
3.000 - 3.999	+0.003/-0.000	7/32 (.219)	Dia. B - .437	+0.000/-0.003	0.250	Dia. B - .001	+0.000/-0.002
4.000 - 5.499	+0.003/-0.000	8/32 (.250)	Dia. B - .500	+0.000/-0.003	0.281	Dia. B - .001	+0.000/-0.002
5.500 - 6.999	+0.003/-0.000	9/32 (.281)	Dia. B - .562	+0.000/-0.003	0.312	Dia. B - .002	+0.000/-0.002
7.000 - 9.999	+0.003/-0.000	10/32 (.312)	Dia. B - .625	+0.000/-0.004	0.344	Dia. B - .002	+0.000/-0.002
10.000 - 11.999	+0.004/-0.000	11/32 (.344)	Dia. B - .687	+0.000/-0.004	0.375	Dia. B - .002	+0.000/-0.002
12.000 - 13.999	+0.004/-0.000	12/32 (.375)	Dia. B - .750	+0.000/-0.005	0.406	Dia. B - .002	+0.000/-0.002
14.000 - 17.999	+0.004/-0.000	13/32 (.406)	Dia. B - .812	+0.000/-0.005	0.437	Dia. B - .002	+0.000/-0.002
18.000 +	+0.005/-0.000	14/32 (.437)	Dia. B - .875	+0.000/-0.006	0.469	Dia. B - .002	+0.000/-0.002

* If used with wear rings, refer to wear ring bore diameter, see [Section 9](#).

Above table reflects recommended cross-sections for piston diameters shown. Alternate cross-sections and additional sizes may be considered. Consult www.parker.com/eps/FluidPower for additional cross-sections and sizes, hardware specifications, and part number availability. Contact your Parker representative for assistance.

06/01/2014

Table 6-23. 8400 and 8500 Profiles — Piston Gland Dimensions, ♦Parker Standard Sizes

B Bore Diameter		A Groove Diameter		C Groove Width	E Piston Diameter*		Part Number (Replace "8x" with appropriate Profile Code)
Dia	Tol.	Dia	Tol.	+0.015/-.000	Dia	Tol.	
0.250	+0.002/-.000	0.125	+0.000/-.002	0.093	0.249	+0.000/-.001	41808x0200125
0.312	+0.002/-.000	0.187	+0.000/-.002	0.093	0.311	+0.000/-.001	41808x0200187
0.375	+0.002/-.000	0.250	+0.000/-.002	0.093	0.374	+0.000/-.001	41808x0200250
0.437	+0.002/-.000	0.250	+0.000/-.002	0.125	0.436	+0.000/-.001	41808x0300250
0.500	+0.002/-.000	0.312	+0.000/-.002	0.125	0.499	+0.000/-.001	41808x0300312
0.625	+0.002/-.000	0.375	+0.000/-.002	0.156	0.624	+0.000/-.001	41808x0400375
0.750	+0.002/-.000	0.500	+0.000/-.002	0.156	0.749	+0.000/-.001	41808x0400500
0.875	+0.002/-.000	0.625	+0.000/-.002	0.156	0.874	+0.000/-.001	41808x0400625
1.000	+0.002/-.000	0.750	+0.000/-.002	0.156	0.999	+0.000/-.001	41808x0400750
1.125	+0.002/-.000	0.875	+0.000/-.002	0.156	1.124	+0.000/-.001	41808x0400875
1.250	+0.002/-.000	1.000	+0.000/-.002	0.156	1.249	+0.000/-.001	41808x0401000
1.375	+0.002/-.000	1.062	+0.000/-.002	0.188	1.374	+0.000/-.001	41808x0501062
1.500	+0.002/-.000	1.187	+0.000/-.002	0.188	1.499	+0.000/-.001	41808x0501187
1.625	+0.002/-.000	1.312	+0.000/-.002	0.188	1.624	+0.000/-.001	41808x0501312
1.750	+0.002/-.000	1.375	+0.000/-.002	0.218	1.749	+0.000/-.002	41808x0601375
1.875	+0.002/-.000	1.500	+0.000/-.002	0.218	1.874	+0.000/-.002	41808x0601500
2.000	+0.002/-.000	1.625	+0.000/-.002	0.218	1.999	+0.000/-.002	41808x0601625
2.125	+0.002/-.000	1.750	+0.000/-.002	0.218	2.124	+0.000/-.002	41808x0601750
2.250	+0.002/-.000	1.875	+0.000/-.002	0.218	2.249	+0.000/-.002	41808x0601875
2.375	+0.002/-.000	2.000	+0.000/-.002	0.218	2.374	+0.000/-.002	41808x0602000
2.500	+0.002/-.000	2.125	+0.000/-.002	0.218	2.499	+0.000/-.002	41808x0602125
2.625	+0.002/-.000	2.250	+0.000/-.002	0.218	2.624	+0.000/-.002	41808x0602250
2.750	+0.002/-.000	2.375	+0.000/-.002	0.218	2.749	+0.000/-.002	41808x0602375
2.875	+0.002/-.000	2.500	+0.000/-.002	0.218	2.874	+0.000/-.002	41808x0602500
3.000	+0.003/-.000	2.562	+0.000/-.003	0.250	2.999	+0.000/-.002	41808x0702562
3.250	+0.003/-.000	2.812	+0.000/-.003	0.250	3.249	+0.000/-.002	41808x0702812
3.500	+0.003/-.000	3.062	+0.000/-.003	0.250	3.499	+0.000/-.002	41808x0703062
3.750	+0.003/-.000	3.312	+0.000/-.003	0.250	3.749	+0.000/-.002	41808x0703312
4.000	+0.003/-.000	3.500	+0.000/-.003	0.281	3.999	+0.000/-.002	41808x0803500
4.250	+0.003/-.000	3.750	+0.000/-.003	0.281	4.249	+0.000/-.002	41808x0803750
4.500	+0.003/-.000	4.000	+0.000/-.003	0.281	4.499	+0.000/-.002	41808x0804000
4.750	+0.003/-.000	4.250	+0.000/-.003	0.281	4.749	+0.000/-.002	41808x0804250
5.000	+0.003/-.000	4.500	+0.000/-.003	0.281	4.999	+0.000/-.002	41808x0804500
5.500	+0.003/-.000	4.937	+0.000/-.003	0.312	5.498	+0.000/-.002	41808x0904937
6.000	+0.003/-.000	5.437	+0.000/-.003	0.312	5.998	+0.000/-.002	41808x0905437
6.500	+0.003/-.000	5.937	+0.000/-.003	0.312	6.498	+0.000/-.002	41808x0905937
7.000	+0.003/-.000	6.375	+0.000/-.004	0.344	6.998	+0.000/-.002	41808x1006375
8.000	+0.003/-.000	7.375	+0.000/-.004	0.344	7.998	+0.000/-.002	41808x1007375

* If used with wear rings, refer to wear ring bore diameter, see [Section 9](#).

Above table reflects recommended cross-sections for piston diameters shown. Alternate cross-sections and additional sizes may be considered. Consult www.parker.com/eps/FluidPower for additional cross-sections and sizes, hardware specifications, and part number availability. Contact your Parker representative for assistance.

Table 6-23. 8400 and 8500 Profiles – Piston Gland Dimensions, ♦Parker Standard Sizes (cont'd)

B Bore Diameter		A Groove Diameter		C Groove Width	E Piston Diameter*		Part Number (Replace "8x" with appropriate Profile Code)
Dia	Tol.	Dia	Tol.	+015/ -000	Dia	Tol.	
10.000	+004/-000	9.312	+000/-004	0.375	9.998	+000/-002	41808x1109312
12.000	+004/-000	11.250	+000/-005	0.406	11.998	+000/-002	41808x1211250
14.000	+004/-000	13.187	+000/-005	0.437	13.998	+000/-002	41808x1313187
16.000	+004/-000	15.187	+000/-005	0.437	15.998	+000/-002	41808x1315187
18.000	+005/-000	17.125	+000/-006	0.469	17.998	+000/-002	41808x1417125

* If used with wear rings, refer to wear ring bore diameter, see [Section 9](#).

Above table reflects recommended cross-sections for piston diameters shown. Alternate cross-sections and additional sizes may be considered. Consult www.parker.com/eps/FluidPower for additional cross-sections and sizes, hardware specifications, and part number availability. Contact your Parker representative for assistance.

Symmetrical Seal SL Profile

Catalog EPS 5370/USA

SL Profile, Dual Compound Dual Lip Seal



Parker's SL profile is considered a multiple lip seal. The primary sealing lip is provided by the precision knife trimmed rubber element that snaps into the Molythane® base. The base of the SL profile provides the secondary lip which is aligned directly below the primary lip to provide extrusion, and wear resistance. The SL profile combines the sealing benefit of rubber with the wear and strength of Molythane. The beveled rubber lip geometry is excellent for cutting fluid film and the squeeze forces across the lips maintain sealing contact under low pressure or vacuum. The ability of Parker to supply a variety of rubber compounds allows the SL profile to be compatible with a wide range of pressure, temperature and fluids. The SL profile is designed to work as a stand alone rod seal or can be used in tandem with a buffer seal. In piston applications, this seal will function as a unidirectional seal. Dual SL profile seals should not be installed back-to-back in bi-directional pressure applications, as a pressure trap between the seals may occur.

6

Technical Data

Standard Materials*	Temperature Range	Pressure Range†	Surface Speed
Rubber Element: N4180A80	-40°F to +250°F (-40°C to +121°C)		
N4182A75	-65°F to +275°F (-54°C to +135°C)		
Base: P4615A90	-65°F to +200°F (-54°C to +93°C)	5,000 psi (344 bar)	< 1.6 ft/s (0.5 m/s)



SL Cross-Section

***Alternate Materials:** For applications that may require an alternate material, please contact your local Parker seal representative.

†Pressure Range without wear rings. If used with wear rings, see [Table 2-4, page 2-5](#).

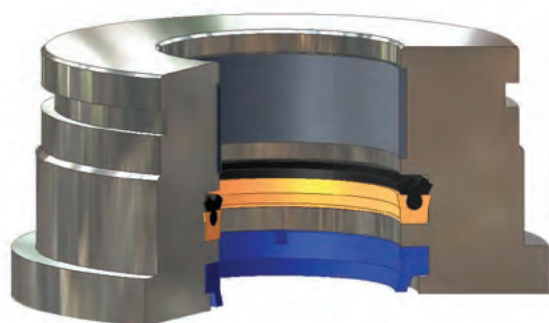

SL installed in Rod Gland

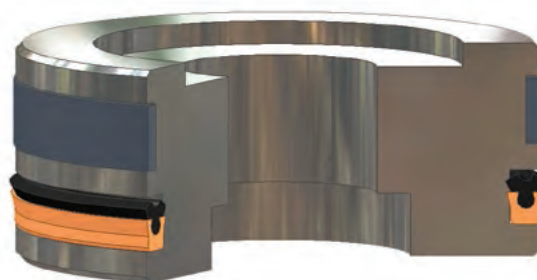

SL installed in Piston Gland

06/01/2014

Part Number Nomenclature – SL Profile

Table 6-24. SL Profile

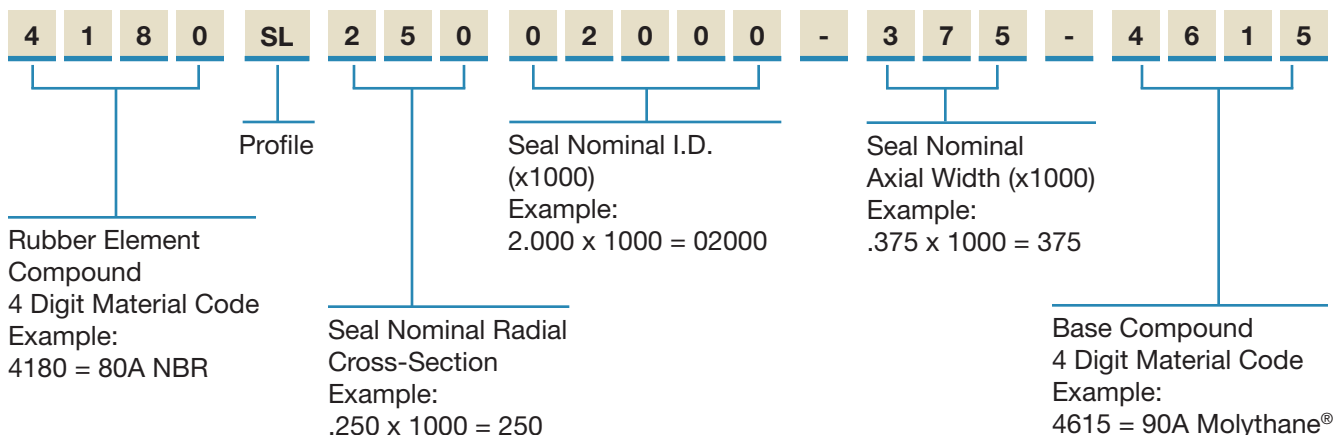

Rod Gland Dimensions – SL Profile

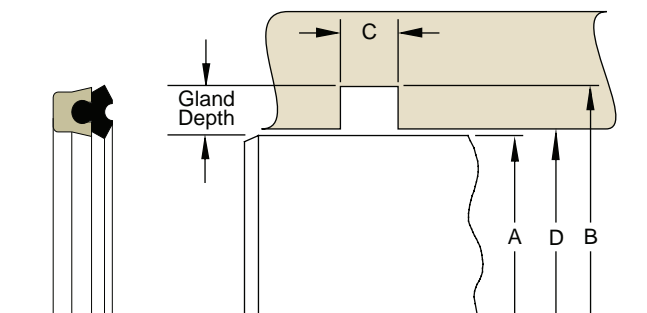

Please refer to Engineering [Section 2](#), [page 2-8](#) for surface finish and additional hardware considerations.

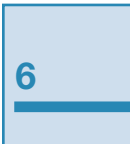

Table 6-25. SL Profile – Rod Gland Calculation

A Rod Diameter		Seal		B Groove Diameter		C Groove Width	D Throat Diameter*	
Range	Tol.	Cross Section	Axial Width	Calculation	Tol.	+0.015/-.000	Calculation	Tol.
1.000 - 1.999	+0.000/-.002	3/16 (.187)	5/16 (.312)	Dia. A + .375	+0.002/-.000	0.343	Dia. A + .001	+0.002/-.000
2.000 - 5.999	+0.000/-.002	1/4 (.250)	3/8 (.375)	Dia. A + .500	+0.003/-.000	0.412	Dia. A + .001	+0.003/-.000
6.000 +	+0.000/-.002	3/8 (.375)	5/8 (.625)	Dia. A + .750	+0.005/-.000	0.687	Dia. A + .002	+0.004/-.000

* If used with wear rings, refer to wear ring throat diameter, see [Section 9](#).

Above table reflects recommended cross-sections for rod diameters shown. Alternate cross-sections and additional sizes may be considered. Consult www.parker.com/eps/FluidPower for additional cross-sections and sizes, hardware specifications, and part number availability. Contact your Parker representative for assistance.

Above table reflects recommended cross-sections for piston diameters shown. Alternate cross-sections and additional sizes may be considered. Consult www.parker.com/eps/FluidPower for additional cross-sections and sizes, hardware specifications, and part number availability. Contact your Parker representative for assistance.

* If used with wear rings, refer to wear ring bore diameter, see [Section 9](#).

Range	Tol.	Cross Section	Axial Width	Calculation	Tol.	Groove Diameter	Groove Width	Calculation	Tol.	
1.500 - 2.499	+0.02/-0.000	3/16 (.187)	5/16 (.312)	Dia. A - .375	+0.00/-0.02	A	C	0.343	Dia. A - .001	+0.00/-0.002
2.500 - 7.499	+0.003/-0.000	1/4 (.250)	3/8 (.375)	Dia. A - .500	+0.00/-0.003	A	C	0.412	Dia. A - .001	+0.00/-0.002
7.500 +	+0.004/-0.00	3/8 (.375)	5/8 (.625)	Dia. A - .750	+0.00/-0.005	A	C	0.687	Dia. A - .002	+0.00/-0.002

Table 6-26. SL Profile – Piston Gland Calculation

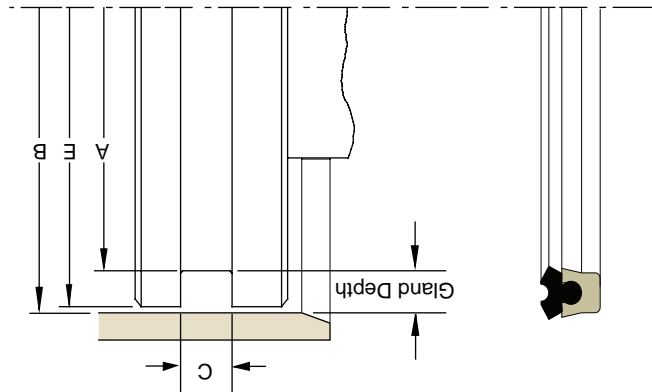

Piston Gland Dimensions – SL Profile

Please refer to [Engineering Section 2](#), [page 2-8](#) for surface finish and additional hardware considerations.

Click to Go to SECTION Table of Contents

Click to Go to CATALOG Table of Contents

Symmetrical Seal US Profile

US Profile, Symmetrical U-cup Seal

The Parker US profile is a symmetrical, beveled lip u-cup designed for use in hydraulic cylinder applications. The symmetrical shape allows interchangeability between rod and piston applications. A precision knife trimming process is utilized to create the beveled sealing lips. This ensures that the inside and outside diameter sealing edges provide excellent fluid wiping action. The US profile is a single acting seal. Two seals can be installed back to back, in separate grooves, to seal dual acting pistons without pressure trapping fluid between the seals. The US profile is an economical choice, available in Parker's wear resistant and extrusion resistant Molythane® compound.



US Cross-Section

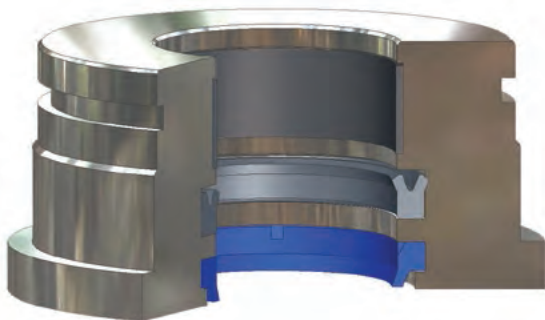

US installed in Rod Gland

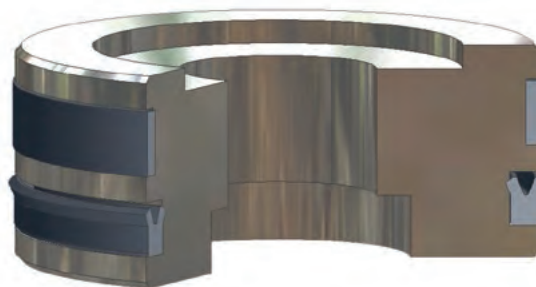

US installed in Piston Gland

Technical Data

Standard Materials*	Temperature Range	Pressure Range†	Surface Speed
P4615A90	-65°F to +200°F (-54°C to +93°C)	5,000 psi (344 bar)	< 1.6 ft/s (0.5 m/s)

***Alternate Materials:** For applications that may require an alternate material, please contact your local Parker seal representative.

†**Pressure Range** without wear rings. If used with wear rings, see [Table 2-4, page 2-5](#).

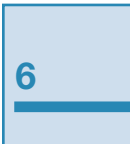

Part Number Nomenclature – US Profile

Table 6-27. US Profile

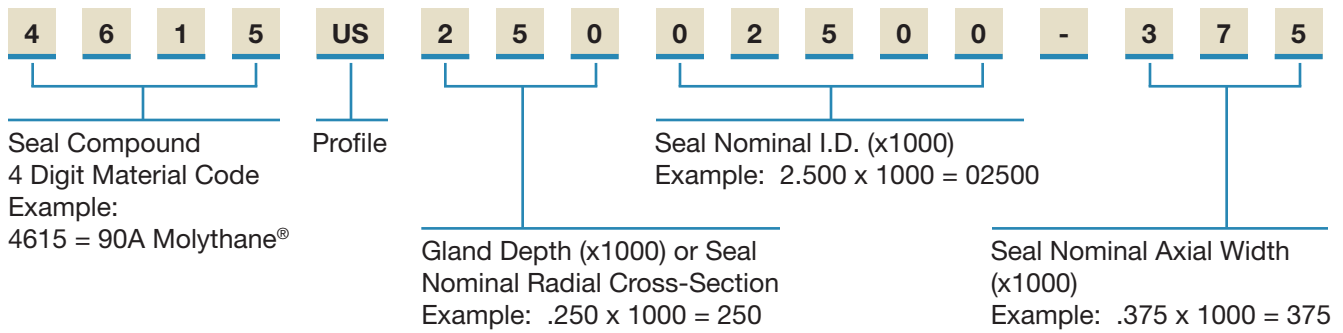

Rod Gland Dimensions – US Profile

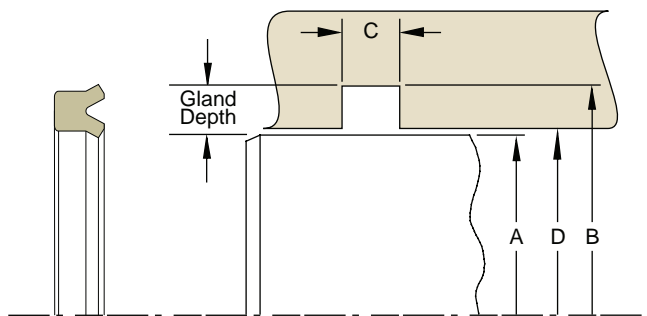

Please refer to Engineering [Section 2](#), [page 2-8](#) for surface finish and additional hardware considerations.

Table 6-28. US Profile – Rod Gland Calculation

A Rod Diameter		Seal		B Groove Diameter		C Groove Width	D Throat Diameter*	
Range	Tol.	Cross Section	Axial Width	Calculation	Tol.	+0.015/ -.000	Calculation	Tol.
0.062 - 0.624	+0.000/-0.001	1/8 (.125)	3/16 (.187)	Dia. A + .250	+0.002/-0.000	0.206	Dia. A + .001	+0.002/-0.000
0.625 - 0.999	+0.000/-0.001	1/8 (.125)	1/4 (.250)	Dia. A + .250	+0.002/-0.000	0.275	Dia. A + .001	+0.002/-0.000
1.000 - 1.499	+0.000/-0.002	3/16 (.187)	5/16 (.312)	Dia. A + .375	+0.002/-0.000	0.343	Dia. A + .001	+0.002/-0.000
1.500 - 1.999	+0.000/-0.002	3/16 (.187)	3/8 (.375)	Dia. A + .375	+0.002/-0.000	0.413	Dia. A + .001	+0.002/-0.000
2.000 - 3.499	+0.000/-0.002	1/4 (.250)	3/8 (.375)	Dia. A + .500	+0.003/-0.000	0.413	Dia. A + .001	+0.003/-0.000
3.500 - 4.999	+0.000/-0.002	5/16 (.312)	1/2 (.500)	Dia. A + .625	+0.004/-0.000	0.550	Dia. A + .002	+0.003/-0.000
5.000 +	+0.000/-0.002	3/8 (.375)	5/8 (.625)	Dia. A + .750	+0.005/-0.000	0.688	Dia. A + .002	+0.004/-0.000

* If used with wear rings, refer to wear ring throat diameter, see [Section 9](#).

Above table reflects recommended cross-sections for Rod diameters shown. Alternate cross-sections and additional sizes may be considered. Consult www.parker.com/eps/FluidPower for additional cross-sections and sizes, hardware specifications, and part number availability. Contact your Parker representative for assistance.

Piston Gland Dimensions – US Profile

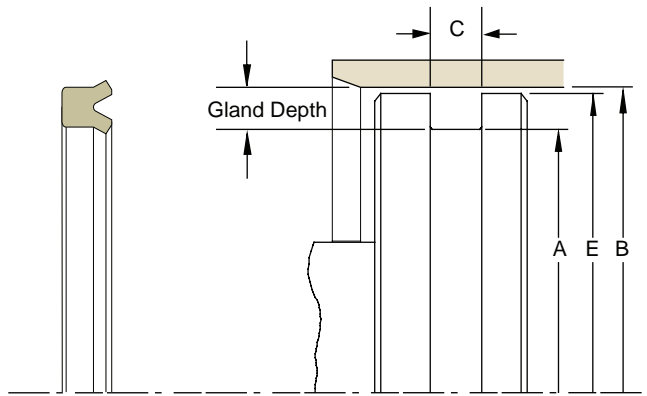

Please refer to Engineering [Section 2](#), [page 2-8](#) for surface finish and additional hardware considerations.

Table 6-29. US Profile – Piston Gland Calculation

B Bore Diameter		Seal		A Groove Diameter		C Groove Width	E Piston Diameter*	
Range	Tol.	Cross Section	Axial Width	Calculation	Tol.	+0.015/ -.000	Calculation	Tol.
0.312 - 1.499	+0.002/-.000	1/8 (.125)	1/8 (.125)	Dia. B - .250	+0.000/-.002	0.138	Dia. B - .001	+0.000/-.001
1.500 - 2.999	+0.002/-.000	3/16 (.187)	3/16 (.187)	Dia. B - .375	+0.000/-.002	0.206	Dia. B - .001	+0.000/-.002
3.000 - 5.999	+0.003/-.000	1/4 (.250)	1/4 (.250)	Dia. B - .500	+0.000/-.003	0.275	Dia. B - .001	+0.000/-.002
6.000 - 9.999	+0.003/-.000	5/16 (.312)	5/16 (.312)	Dia. B - .625	+0.000/-.004	0.343	Dia. B - .002	+0.000/-.002
10.000 +	+0.004/-.000	3/8 (.375)	3/8 (.375)	Dia. B - .750	+0.000/-.005	0.413	Dia. B - .002	+0.000/-.002

* If used with wear rings, refer to wear ring bore diameter, see [Section 9](#).

Above table reflects recommended cross-sections for piston diameters shown. Alternate cross-sections and additional sizes may be considered. Consult www.parker.com/eps/FluidPower for additional cross-sections and sizes, hardware specifications, and part number availability. Contact your Parker representative for assistance.

Symmetrical Seal AN6226 Profile

Catalog EPS 5370/USA

AN6226 Profile, Industrial, Standard, Light Load Rubber U-cup



Parker's AN6226 Style u-cup has a square format where the nominal cross section is equal to the height. Although widely used in the fluid power industry for low friction pneumatics, this profile was originally designed for early aircraft and ordnance service. Many units still use this type u-cup. The AN6226 profile is available in the most popular sizes per Army/Navy (AN) specifications and is made of a standard 70 Shore A nitrile compound.

Technical Data

Standard Material*	Temperature Range	Pressure Range†		Surface Speed**
		Hydr.	Pneu.	
N4295A70	-40°F to +250°F (-40°C to +121°C)	800 psi (55 bar)	250 psi (17 bar)	< 1.6 ft/s (0.5 m/s)

***Alternate Materials:** For applications that may require an alternate material, please contact your local Parker seal representative.

†**Pressure Range** without wear rings. If used with wear rings, see [Table 2-4, page 2-5](#).

****Surface Speed** for pneumatic applications < 3.3 ft/s (1.0 m/s).



AN6226 Cross-Section

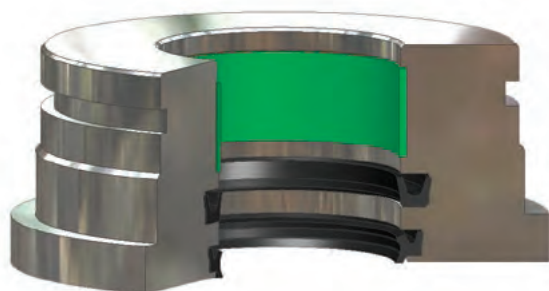

AN6226 installed in Rod Gland

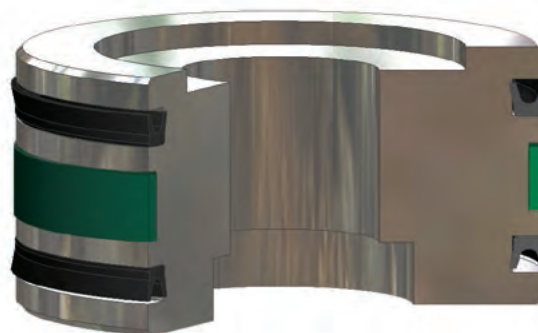

AN6226 installed in Piston Gland

Part Number Nomenclature – AN6226 Profile

Table 6-30. AN6226 Profile

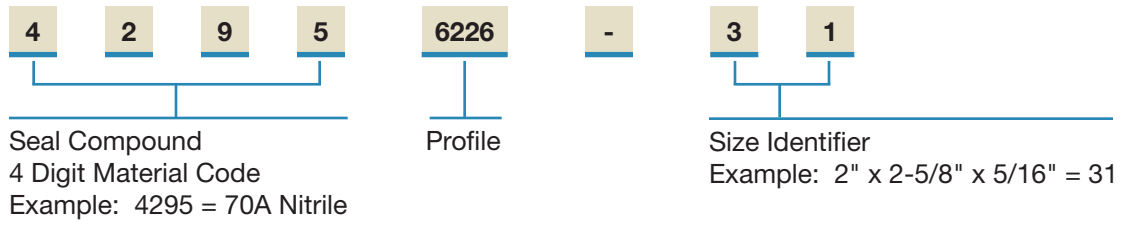

Gland Dimensions – AN6226 Profile – [See Appendix D](#)

Piston Seals

Contents

Product Offering 7-2

Decision Tree 7-3

Piston Seal Profiles

- ◆ BP 7-5
- ◆ PSP 7-8
- CT 7-11
- OK 7-13
- PIP 7-15
- B7 7-17
- UP 7-19
- E4 7-21
- BMP 7-23
- TP 7-25
- S5 7-28
- R5 7-30
- CQ 7-32
- OE 7-34
- OG 7-36
- CP 7-38
- OA 7-40
- OQ 7-42

Piston Seal Profiles

Parker offers the most comprehensive range of piston seals in the market today. A variety of profiles such as lip seals, cap seals and squeeze seals are manufactured from proprietary rubber, thermoplastic and PTFE compounds to meet the broad demands of the fluid power industry. The highest quality materials and manufacturing processes are utilized to ensure the best performance possible. Parker's piston seal profiles are available for both uni-directional and bi-directional applications. When combined with wear rings, Parker piston seals have proven to provide long life and leak free performance.



Typical Hydraulic Cylinder

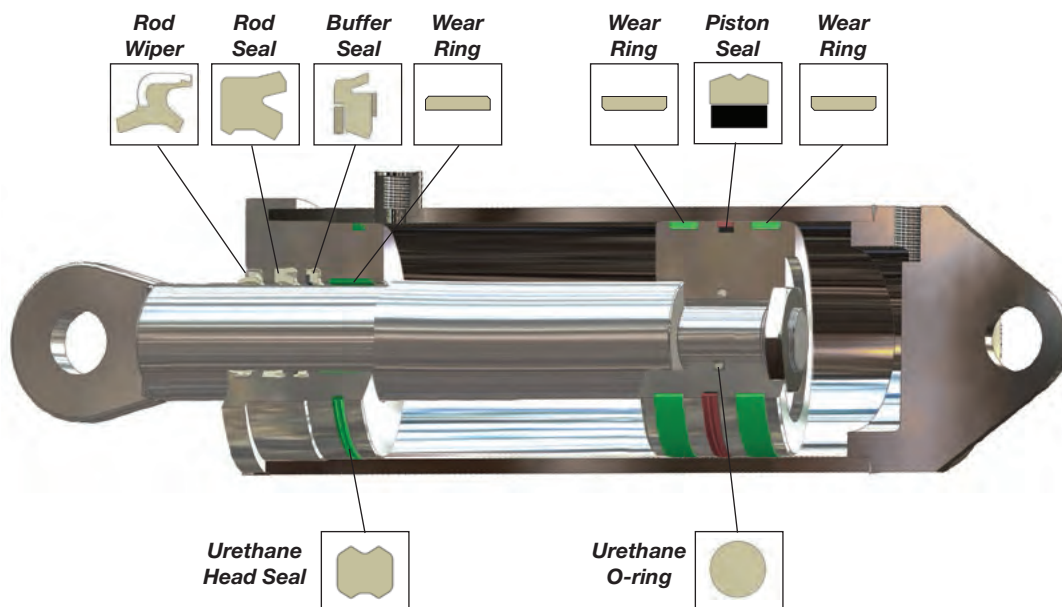

06/01/2014

Piston Seal Product Offering

Catalog EPS 5370/USA

Profiles

Table 7-1: Product Profiles

◆ = Preferred Piston Seal profile

Series	Description	Application (Duty)				Page	Series	Description	Application (Duty)				Page
		Light	Medium	Heavy	Pneu				Light	Medium	Heavy	Pneu	
◆ BP	Premium TPU Cap Seal					7-5	TP	Compact Seal with Anti-Extrusion Technology					7-25
◆ PSP	TPU Piston Cap Seal					7-8	S5	Square PTFE Cap Seal					7-28
CT	Premium PTFE Cap Seal with Anti-Extrusion Technology					7-11	R5	Rectangular PTFE Cap Seal					7-30
OK	High Pressure, Step Cut Cap Piston Seal					7-13	CQ	Premium PTFE Cap Seal with Anti-Drift Technology					7-32
PIP	Loaded Lip Seal with Pressure Inverting Pedestal					7-15	OE	PTFE Piston Cap Seal					7-34
B7	U-cup Piston Seal					7-17	OG	PTFE Buffer Seal					7-36
UP	Industrial U-cup Piston Seal					7-19	CP	PTFE Piston Cap Seal to Retrofit O-ring Gland					7-38
E4	Premium Rounded Lip U-cup Piston Seal					7-21	OA	Compact PTFE Piston Cap Seal					7-40
BMP	Rounded Lip Seal with Bumper Cushion					7-23	OQ	Rotary PTFE Cap Seal					7-42

06/01/2014

Piston Seal Decision Tree

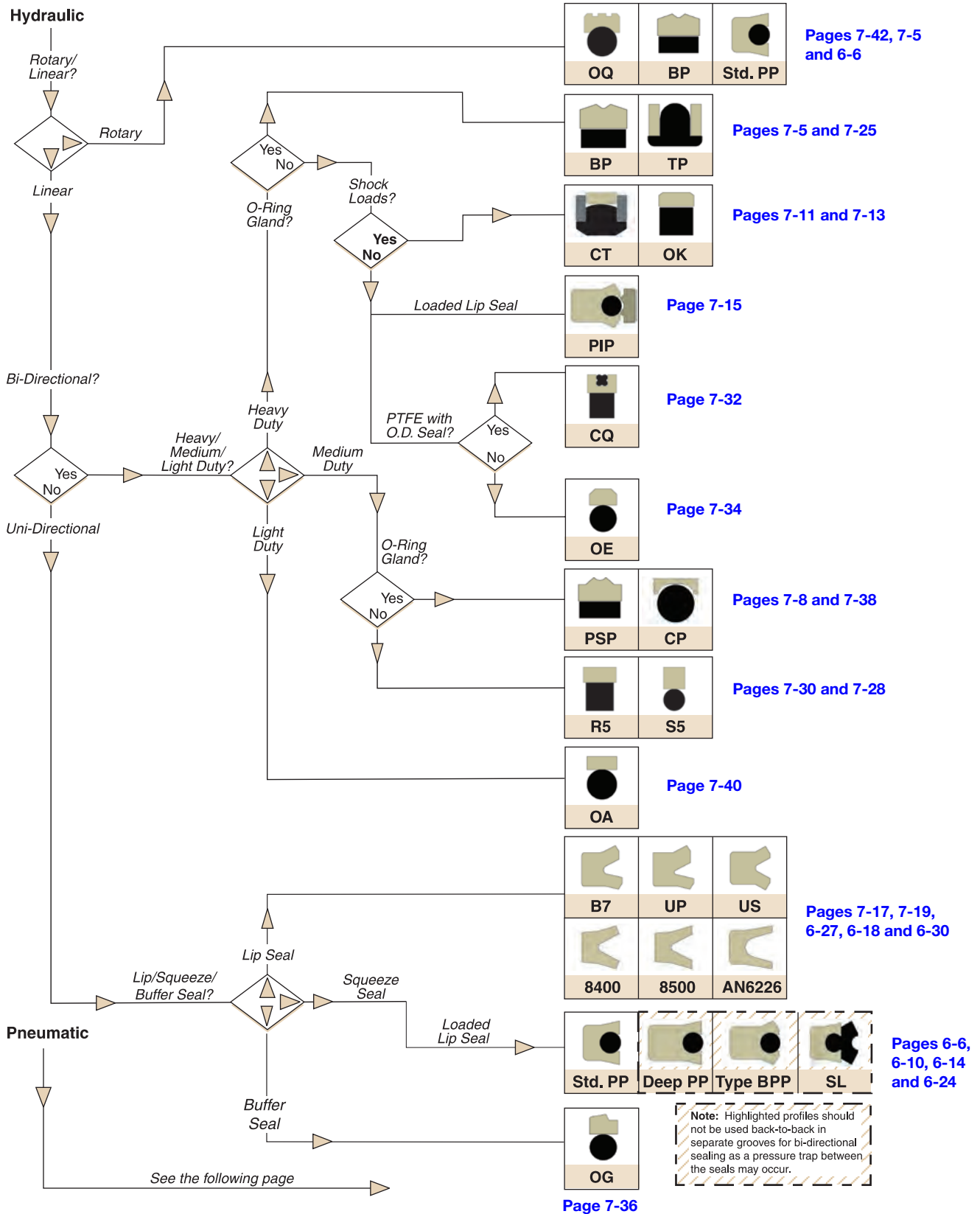

Piston Seal Decision Tree (Continued)

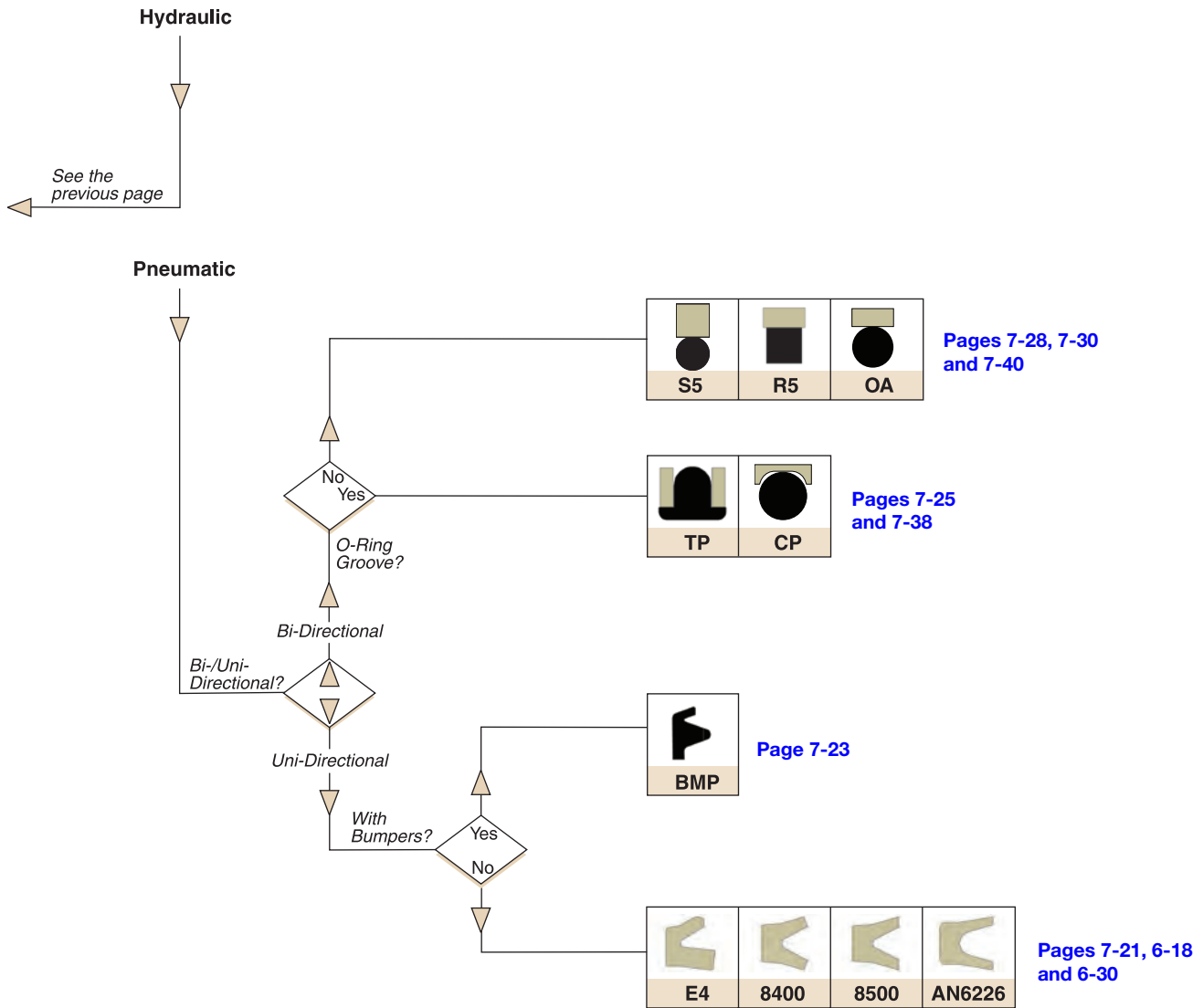

7

Piston Seal BP Profile

◆ Preferred Profile

Catalog EPS 5370/USA



BP Profile, Premium TPU Cap Seal

Parker's BP profile is a squeeze type, bi-directional piston seal for use in medium to heavy duty hydraulic applications. This seal is primarily designed for linear applications but has been successfully used as a low speed rotary seal. The standard material for this profile is Resilon® 4304 polyurethane, compound P4304. This is a proprietary Parker polyurethane offering higher wear resistance, extrusion resistance, and extended temperature range. The Resilon 4304 cap is energized using a resilient nitrile elastomer offering low compression set. The BP profile's geometry provides a fluid reservoir between the two sealing lips which holds system fluid, resulting in reduced breakaway and running friction. The standard style BP profile is designed to retrofit o-ring grooves. The BP profile is easy to install and will resist rolling and twisting in long stroke applications.

The BP profile is sold only as an assembly (seal and energizer). [See part number nomenclature.](#)

Technical Data

Parker Standard Materials	Temperature Range	Pressure Range†	Surface Speed
Cap P4304D60	-65°F to +275°F (-54°C to +135°C)	7,000 psi (482 bar)	< 1.6 ft/s (0.5 m/s)
Energizer A 70A Nitrile	-30°F to +250°F (-34°C to +121°C)		



BP Cross-Section

Alternate Materials: For applications that may require an alternate material, please go to www.parker.com/eps/FluidPower to check current tooling and part number availability, or contact your local Parker representative.

†Pressure Range without wear rings. If used with wear rings, see [Table 2-4, page 2-5.](#)

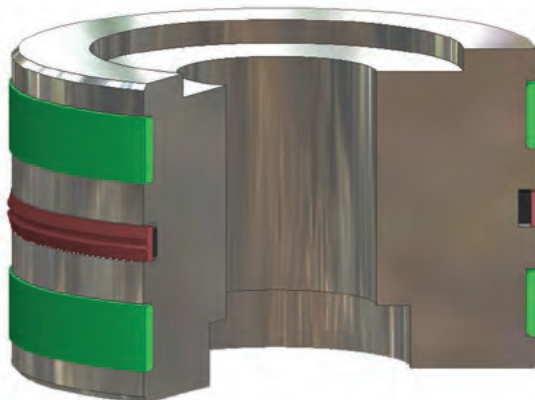

BP installed in Piston Gland

06/01/2014

Part Number Nomenclature – BP Profile

Table 7-2. BP Profile

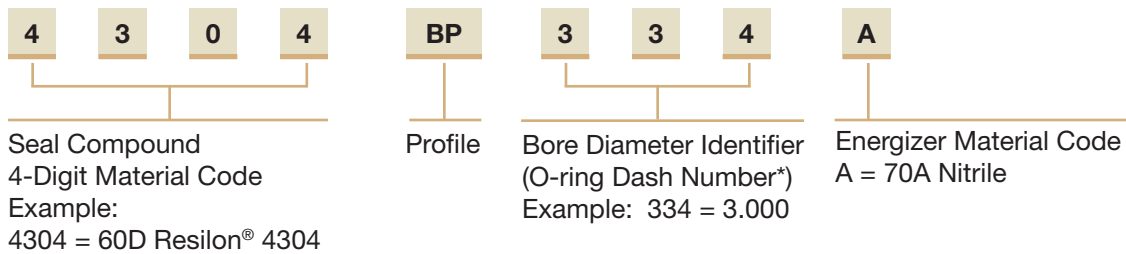

Gland Dimensions – BP Profile

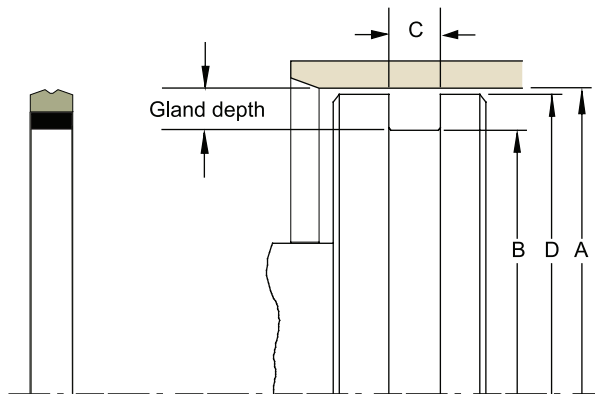

Please refer to Engineering [Section 2, page 2-8](#) for surface finish and additional hardware considerations.

Table 7-3. BP Profile – Piston Gland Calculation

A Bore Diameter*		Ref. O-Ring Dash Number	Groove Depth	B Groove Diameter		C Groove Width +.005/-0.000	D Piston Diameter**	
Range	Tol.			Calc.	Tol.		Calc.	Tol.
1.500 - 1.750	+.002/-0.000	2-218 to 2-222	0.121	Dia. A - .242	+.000/-0.002	0.187	Dia. A - .003	+.000/-0.001
1.875 - 5.000	+.002/-0.000	2-325 to 2-350	0.185	Dia. A - .370	+.000/-0.002	0.281	Dia. A - .003	+.000/-0.001
5.127 - 8.002	+.002/-0.000	2-426 to 2-443	0.237	Dia. A - .474	+.000/-0.002	0.375	Dia. A - .004	+.000/-0.001

* For corresponding o-ring dash number, consult Parker O-ring Handbook, Catalog ORD 5700.

** If used with wear rings, refer to wear ring piston diameter, see [Section 9](#).

Above table reflects recommended cross-sections for bore diameters shown. Alternate cross-sections and additional sizes may be considered. Consult www.parker.com/eps/FluidPower for additional cross-sections and sizes, hardware specifications, and part number availability. Contact your Parker representative for assistance.

Table 7-4. BP Profile – Piston Gland Dimensions, ♦Parker Standard Sizes

A Bore Diameter +0.002/-.000	Hardware Dimensions			D Piston Diameter* +0.000/-.001	Part Number
	B Groove Diameter +0.000/-.002	C Groove Width +0.005/-.000			
1.500	1.258	0.187		1.497	4304BP218A
1.625	1.383	0.187		1.622	4304BP220A
1.750	1.508	0.187		1.747	4304BP222A
2.000	1.630	0.281		1.997	4304BP326A
2.250	1.880	0.281		2.247	4304BP328A
2.500	2.130	0.281		2.497	4304BP330A
2.750	2.380	0.281		2.747	4304BP332A
3.000	2.630	0.281		2.997	4304BP334A
3.250	2.880	0.281		3.247	4304BP336A
3.500	3.130	0.281		3.497	4304BP338A
3.750	3.380	0.281		3.747	4304BP340A
4.000	3.630	0.281		3.997	4304BP342A
4.250	3.880	0.281		4.247	4304BP344A
4.500	4.130	0.281		4.497	4304BP346A
4.750	4.380	0.281		4.747	4304BP348A
5.000	4.630	0.281		4.997	4304BP350A
5.252	4.778	0.375		5.248	4304BP427A
5.502	5.028	0.375		5.498	4304BP429A
5.752	5.278	0.375		5.748	4304BP431A
6.002	5.528	0.375		5.998	4304BP433A
6.502	6.028	0.375		6.498	4304BP437A
7.002	6.528	0.375		6.998	4304BP439A
7.502	7.028	0.375		7.498	4304BP441A
8.002	7.528	0.375		7.998	4304BP443A

* If used with wear rings, refer to wear ring piston diameter, see [Section 9](#).

Above table reflects recommended cross-sections for bore diameters shown. Alternate cross-sections and additional sizes may be considered. Consult www.parker.com/eps/FluidPower for additional cross-sections and sizes, hardware specifications, and part number availability. Contact your Parker representative for assistance.

Piston Seal PSP Profile

◆ Preferred Profile

Catalog EPS 5370/USA

Click to Go to
SECTION
Table of Contents

Click to Go to
CATALOG
Table of Contents



Parker's PSP profile is a squeeze type, bi-directional piston seal for use in light to medium duty hydraulic applications. Available from proprietary Parker polyurethanes, the PSP offers low friction, abrasion and extrusion resistance. The nitrile elastomer energizer ensures resistance to compression set to increase seal life. The PSP profile's geometry provides a fluid reservoir between the two sealing lips which holds system fluid, resulting in reduced breakaway and running friction. Designed to retrofit grooves for a single o-ring or an o-ring with two back-ups, the PSP profile is easy to install and resists rolling and twisting in long stroke applications.

The PSP profile is sold only as an assembly (seal and energizer). See [part number nomenclature](#).

Technical Data

Parker Standard Materials	Temperature Range	Pressure Range†	Surface Speed
Cap P4622A90	-65°F to +225°F (-54°C to +107°C)	5000 psi (344 bar)	< 1.6 ft/s (0.5 m/s)
Energizer A 70A Nitrile	-30°F to +250°F (-34°C to +121°C)		
Additional Cap Material P4300A90	-65°F to +275°F (-54°C to +135°C)	5,000 psi (344 bar)	> 1.6 ft/s (0.5 m/s)

PSP Cross-Section



Alternate Materials: For applications that may require an alternate material, please go to "www.parker.com/eps/FluidPower to check current tooling and part number availability, or contact your local Parker representative.

†**Pressure Range** without wear rings. If used with wear rings, see [Table 2-4, page 2-5](#).

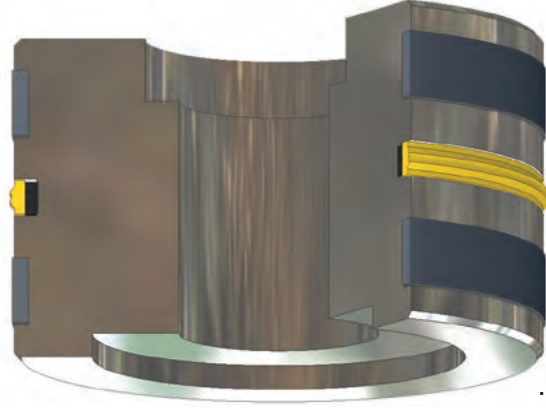

PSP installed in Piston Gland

06/01/2014

Part Number Nomenclature – PSP Profile

Table 7-5. PSP Profile

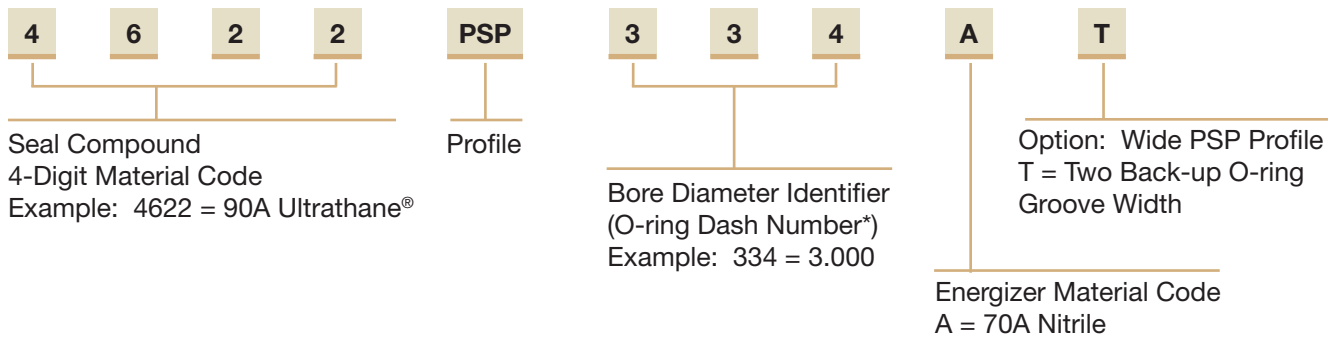

Gland Dimensions – PSP Profile

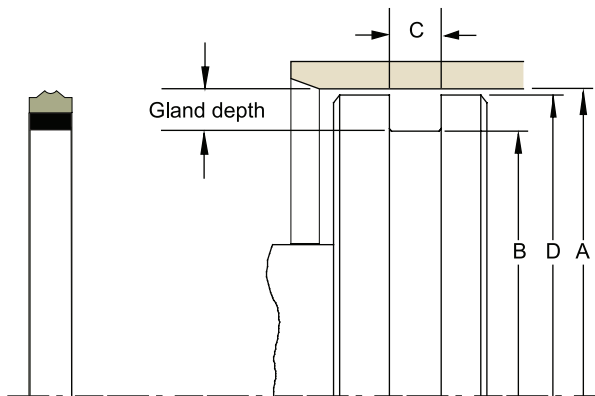

Please refer to Engineering [Section 2](#), [page 2-8](#) for surface finish and additional hardware considerations.

Table 7-6. PSP Profile – Piston Gland Calculation

A Bore Diameter		Ref. O-Ring Dash Number	Groove Depth	B Groove Diameter		C Groove Width	D Piston Diameter**	
Range	Tol.			Calc.	Tol.		Calc.	Tol.
1.000 - 1.750	+.002/-0.000	2-210 to 2-222	0.121	Dia. A - .242	+.000/-0.002	0.187	Dia. A - .003	+.000/-0.001
1.875 - 4.000	+.002/-0.000	2-325 to 2-342	0.185	Dia. A - .370	+.000/-0.002	0.281	Dia. A - .003	+.000/-0.001

* For corresponding o-ring dash number, consult Parker O-ring Handbook, Catalog ORD 5700.

** If used with wear rings, refer to wear ring piston diameter, see [Section 9](#).

Above table reflects recommended cross-sections for bore diameters shown. Alternate cross-sections and additional sizes may be considered. Consult www.parker.com/eps/FluidPower for additional cross-sections and sizes, hardware specifications, and part number availability. Contact your Parker representative for assistance.

Table 7-7. PSP Profile – Piston Gland Dimensions, ♦Parker Standard Sizes

Hardware Dimensions				Part Number
A Bore Diameter	B Groove Diameter	C Groove Width	D Piston Diameter*	
+0.002/-0.000	+0.000/-0.002	+0.005/-0.000	+0.000/-0.001	
1.000	0.758	0.187	0.997	4622PSP210A
1.125	0.883	0.187	1.122	4622PSP212A
1.250	1.008	0.187	1.247	4622PSP214A
1.375	1.133	0.187	1.372	4622PSP216A
1.500	1.258	0.187	1.497	4622PSP218A
1.625	1.383	0.187	1.622	4622PSP220A
1.750	1.508	0.187	1.747	4622PSP222A
2.000	1.630	0.281	1.997	4622PSP326A
2.250	1.880	0.281	2.247	4622PSP328A
2.500	2.130	0.281	2.497	4622PSP330A
2.750	2.380	0.281	2.747	4622PSP332A
3.000	2.630	0.281	2.872	4622PSP334A
3.250	2.880	0.281	2.997	4622PSP336A
3.500	3.130	0.281	3.122	4622PSP338A
3.750	3.380	0.281	3.247	4622PSP340A
4.000	3.630	0.281	3.372	4622PSP342A

* If used with wear rings, refer to wear ring piston diameter, see [Section 9](#).

Above table reflects recommended cross-sections for bore diameters shown. Alternate cross-sections and additional sizes may be considered. Consult www.parker.com/eps/FluidPower for additional cross-sections and sizes, hardware specifications, and part number availability. Contact your Parker representative for assistance.

Piston Seal CT Profile

Catalog EPS 5370/USA

CT Profile, Premium PTFE Cap Seal with Anti-Extrusion Technology

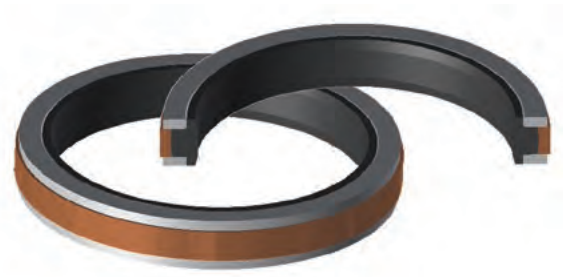

The Parker CT profile is a robust design for heavy duty hydraulic applications. The CT profile is an excellent choice for sealing mobile hydraulic applications that experience shock loads. The CT profile is a four piece assembly made up of a rubber energizer, PTFE cap and two back-up rings. In application, fluid pressure forces the rubber energizer to apply increased load against the PTFE cap and back-up rings. This results in increased sealing force against the bore and allows the back-up rings to close off the extrusion gap between the piston and the bore. Once activated by pressure, the back-up rings protect the seal from extruding and keep internal contamination away from the PTFE cap. Parker's CT profile will retrofit non-Parker seals of similar design.

The CT Profile is sold only as an assembly (seal and energizer). See [part number nomenclature](#).

Technical Data

Parker Standard Materials	Temperature Range*	Surface Speed
Cap 0401 40% bronze-filled PTFE	-200°F to +575°F (-129°C to +302°C)	< 5 ft/s (1.5 m/s)
Energizer A 70A Nitrile	-30°F to +250°F (-34°C to +121°C)	
Back-up Rings A Moly-filled Nylon	Temperature Range -65°F to +250°F (-44°C to +121°C)	Pressure Range** 7,500 psi (500 bar)



CT Cross-Section Standard

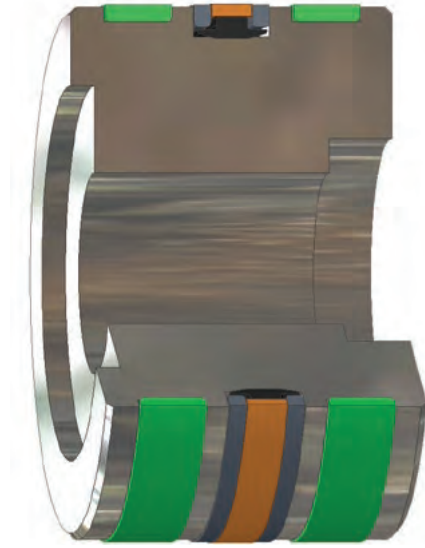

CT installed in Piston Gland

* The temperature range of the CT profile is limited to the energizer. A wider temperature range can be achieved by using alternate energizer and back-up ring compounds.

Alternate Materials: For applications that may require an alternate material, please see [Section 3](#) for alternate PTFE, energizer and back-up materials.

****Pressure Range** without wear rings. If used with wear rings, see [Table 2-4, page 2-5](#).

Part Number Nomenclature – CT Profile

Table 7-8. CT Profile

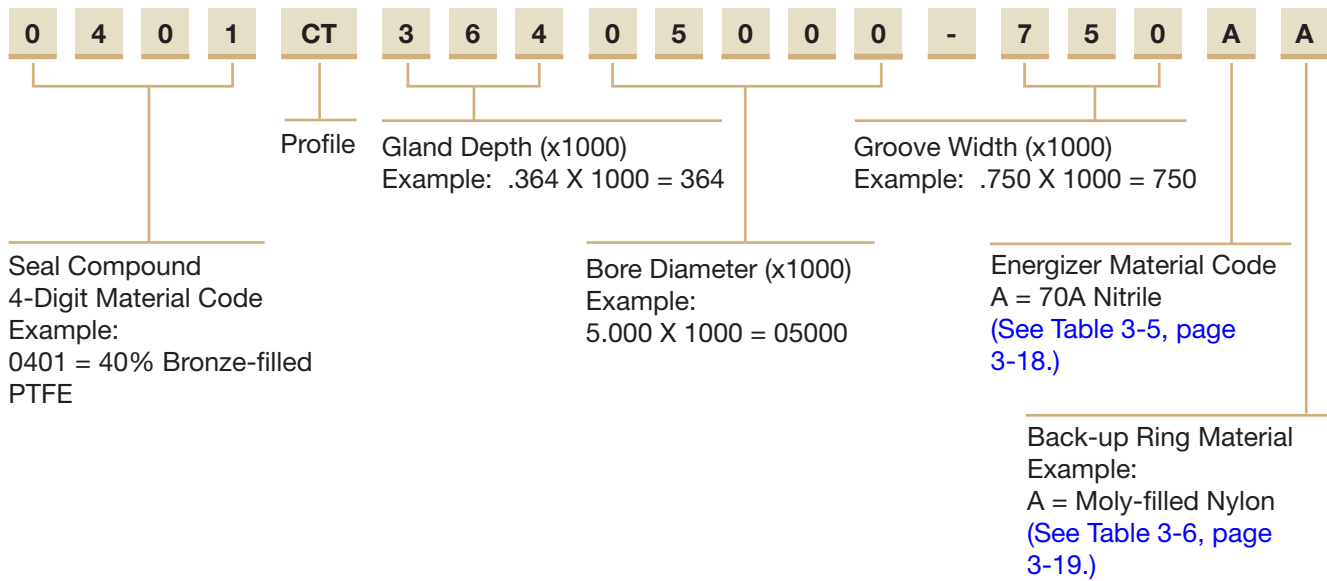

Gland Dimensions – CT Profile

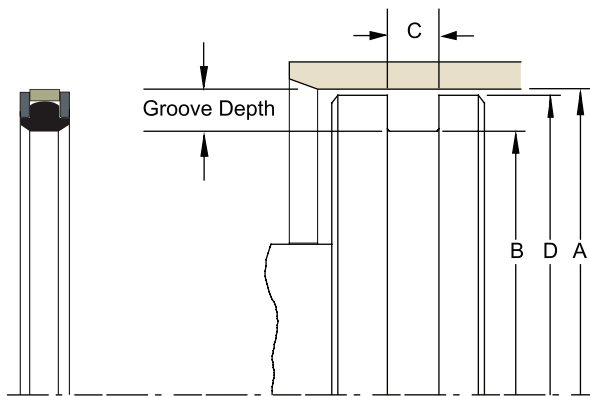

Please refer to Engineering Section 2, page 2-8 for surface finish and additional hardware considerations.

Table 7-9. CT Profile – Piston Gland Calculation

A Bore Diameter		Gland Depth	B Groove Diameter		C Groove Width	D Piston Diameter*	
Range	Tol.		Calc.	Tol.		Calc.	Tol.
3.000 - 4.999	+.004/-.000	0.239	Dia. A - .478	+.000/-.003	0.579	Dia. A - .003	+.000/-.003
5.000 - 7.249	+.004/-.000	0.364	Dia. A - .728	+.000/-.004	0.750	Dia. A - .004	+.000/-.004
7.250 - 12.499	+.005/-.000	0.364	Dia. A - .728	+.000/-.004	0.750	Dia. A - .004	+.000/-.004
12.500 - 20.000	+.006/-.000	0.364	Dia. A - .728	+.000/-.005	0.750	Dia. A - .005	+.000/-.005

* If used with wear rings, refer to wear ring piston diameter, see Section 9.

Above table reflects recommended cross-sections for bore diameters shown. Alternate cross-sections and additional sizes may be considered. Consult www.parker.com/eps/FluidPower for additional cross-sections and sizes, hardware specifications, and part number availability. Contact your Parker representative for assistance.

Piston Seal

OK Profile

Catalog EPS 5370/USA

OK Profile, High Pressure Split Cap Piston Seal

The OK profile is a bi-directional piston seal designed for heavy duty hydraulic applications. Its durable, two-piece design installs easily onto a solid piston without the necessity of auxiliary tools. When installed into the bore, the diameter of the OK profile is compressed to close the step cut in the cap to provide excellent, drift free sealing performance. The glass-filled nylon sealing surface handles the toughest applications. It will resist shock loads, wear, contamination, and will resist extrusion or chipping when passing over cylinder ports. The rectangular nitrile energizer ring ensures resistance to compression set to increase seal life.

The OK profile is sold only as an assembly. [See part number nomenclature.](#)



OK Cross-Section

Technical Data

Standard Materials	Temperature Range	Pressure Range†	Surface Speed
Cap W4650NHH	-65°F to +275°F (-54°C to +135°C)	7250 psi (500 bar)	< 3.3 ft/s (1.0 m/s)
Energizer A 70A Nitrile	-30°F to +250°F (-34°C to +121°C)		

†Pressure Range without wear rings. If used with wear rings, see [Table 2-4, page 2-5.](#)

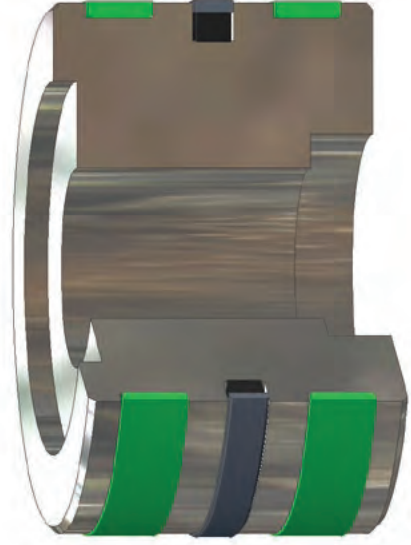

OK installed in Piston Gland

* If used with wear rings, refer to wear ring piston diameter, see [Section 9](#). Above table reflects recommended cross-sections for bore diameters shown. Alternate cross-sections and additional sizes may be considered. Consult www.parker.com/eps/FluidPower for additional cross-sections and sizes, hardware specifications, and part number availability. Contact your Parker representative for assistance.

A	B	C	D
Range	Calc.	Calc.	Calc.
5.250 - 12.000	0.377	0.377	0.377
2.625 - 5.249	0.279	0.282	0.282
1.500 - 2.624	0.269	0.282	0.282
Tol.	Tol.	Tol.	Tol.
+0.05/-0.000	+0.00/-0.005	+0.05/-0.000	+0.00/-0.004
+0.05/-0.000	+0.00/-0.005	+0.00/-0.003	+0.00/-0.003
+0.05/-0.000	+0.00/-0.005	+0.00/-0.002	+0.00/-0.002
Bore Diameter	Groove Diameter	Groove Width	Piston Diameter*

Table 7-11. OK Profile – Piston Gland Calculation

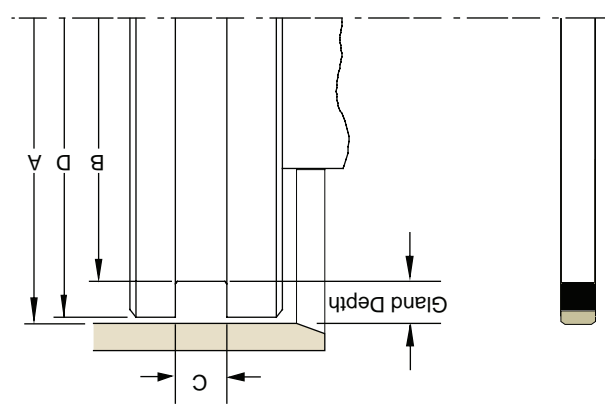

Please refer to Engineering [Section 2](#), [page 2-8](#) for surface finish and additional hardware considerations.

Gland Dimensions – OK Profile

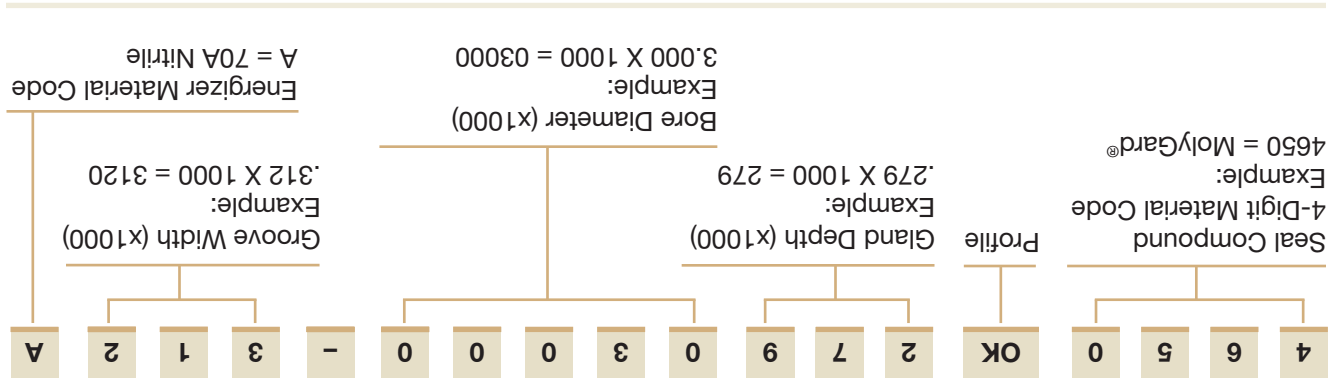
 Part Number Nomenclature – OK Profile
 Table 7-10. OK Profile

Piston Seal PIP Profile

Catalog EPS 5370/USA

PIP Ring® Profile, Loaded Lip Seal with Pressure Inverting Pedestal



The Parker PIP Ring® profile combines a “Pressure Inverting Pedestal” with a Type B PolyPak® to provide excellent, bi-directional piston sealing in hydraulic applications. The PIP Ring conforms to the beveled sealing lips of the Type B PolyPak to provide extrusion resistance when pressure is applied to the heel side of the seal. The PIP Ring profile requires only a single seal groove for installation. This eliminates the use of two PolyPak seals on the piston to save space and increase bearing length.

Note: The PIP Ring profile may be purchased as an assembly (Type B PolyPak and PIP Ring) or separately as a PIP Ring only. If purchasing as an assembly, the standard material is a 4615 Type B PolyPak with 4617 PIP Ring. If you desire alternate material combinations, please order the PIP Ring and Type B PolyPak separately. Call your Parker representative for details.

Technical Data

Standard Materials	Temperature Range	Pressure Range*	Surface Speed
Type B PolyPak P4615A90	-65°F to +200°F (-54°C to +93°C)	5,000 psi (344 bar)	< 1.6 ft/s (0.5 m/s)
PIP Ring P4617D65	-65°F to +250°F (-54°C to +121°C)	5,000 psi (344 bar)	< 1.6 ft/s (0.5 m/s)



PIP Cross-Section

Optional Materials

PIP Ring Z4652D65	-65°F to +275°F (-54°C to +135°C)	10,000 psi** (689 bar)	
W4685R119	-65°F to +500°F (-54°C to +260°C)	10,000+ psi (689 bar)	

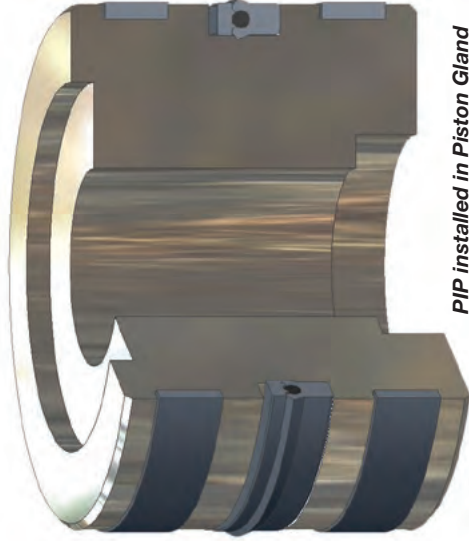

PIP installed in Piston Gland

Alternate Materials: For applications that may require an alternate material, please contact your local Parker representative.

***Pressure Range** without wear rings. If used with wear rings, see [Table 2-4, page 2-5](#).

****Pressure rating** dependent on entire assembly of PolyPak shell/energizer and PIP Ring.

Note: The PIP Ring may be ordered separately. Please contact your local Parker representative.

Click to Go to
 SECTION
 Table of Contents

Click to Go to
 CATALOG
 Table of Contents

Part Number Nomenclature – PIP Ring Assembly

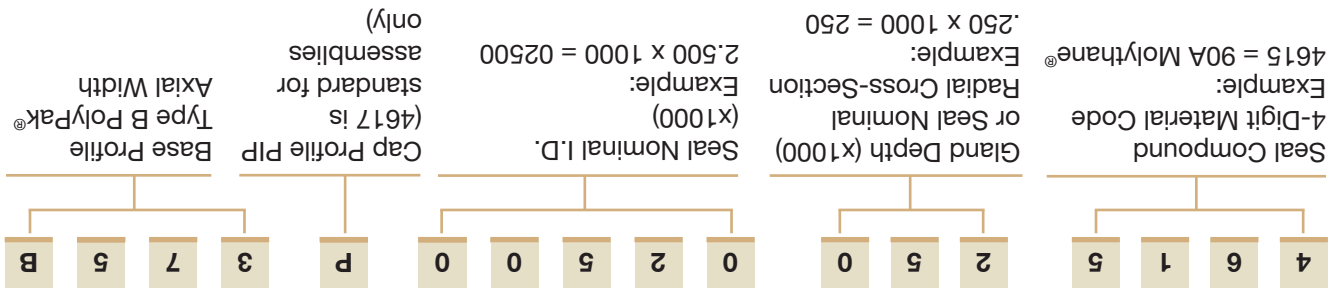
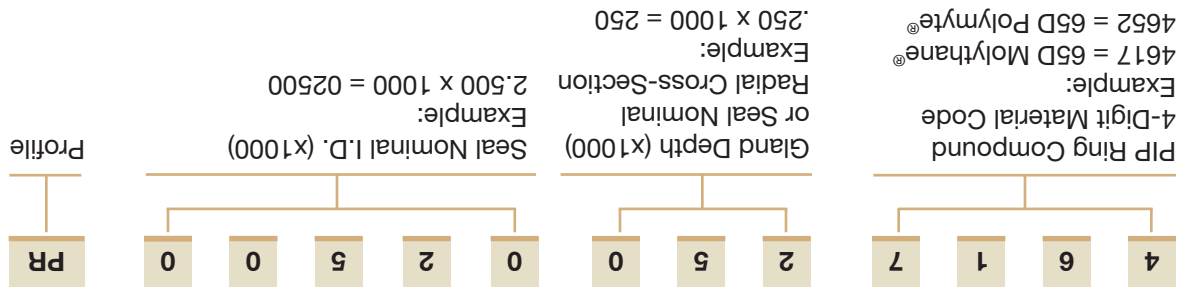
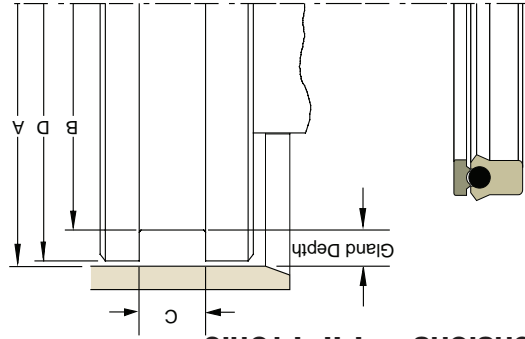

Table 7-12. PIP Ring Assembly

Part Number Nomenclature – PIP Ring Only



Gland Dimensions – PIP Profile



Please refer to Engineering Section 2, page 2-8 for surface finish and additional hardware considerations.

Table 7-14. PIP Profile – Piston Gland Calculation

Bore Diameter		Seal		Groove Diameter		Groove Width		Piston Diameter*	
Range	Tol.	Cross-Section	Axial Width	Calc.	Tol.	Calc.	Tol.	Calc.	Tol.
0.500 - 1.874	+0.02/-0.000	0.125	0.250	DiA. A - .250	+0.00/-0.02	0.340	DiA. A - .001	+0.00/-0.001	
1.875 - 3.124	+0.02/-0.000	0.187	0.312	DiA. A - .375	+0.00/-0.02	0.453	DiA. A - .001	+0.00/-0.002	
3.125 - 5.124	+0.03/-0.000	0.250	0.375	DiA. A - .500	+0.00/-0.03	0.550	DiA. A - .001	+0.00/-0.002	
5.125 - 7.249	+0.03/-0.000	0.250	0.562	DiA. A - .500	+0.00/-0.03	0.756	DiA. A - .001	+0.00/-0.002	
7.250 - 9.999	+0.04/-0.000	0.375	0.625	DiA. A - .750	+0.00/-0.05	0.895	DiA. A - .002	+0.00/-0.002	
10.000 - 40.000	+0.05/-0.000	0.500	0.750	DiA. A - 1.000	+0.00/-0.07	1.100	DiA. A - .002	+0.00/-0.003	

* If used with wear rings, refer to wear ring piston diameter, see Section 9.

Above table reflects recommended cross-sections for bore diameters shown. Alternate cross-sections and additional sizes may be considered. Consult www.parker.com/eps/FluidPower for additional cross-sections and sizes, hardware specifications, and part number availability. Contact your Parker representative for assistance.

06/01/2014



Piston Seal

B7 Profile



B7 Profile, U-cup Piston Seal

The B7 profile is a non-symmetrical, hydraulic cylinder piston seal. The knife trimmed, beveled lip contacts the bore to provide enhanced low to high pressure sealing and wiping action. When installed, the diameter of the B7 profile is stretched slightly to fit the gland. This ensures a tight static seal with the gland and improves stability in application. The B7 profile is available in Parker's proprietary urethane compounds which provide excellent wear, extrusion resistance and compression set resistance. The B7 profile is a uni-directional seal. Two seals can be placed on a piston, back-to-back, in separate glands, offering bi-directional fluid sealing.

Technical Data

Standard Materials	Temperature Range	Pressure Range†	Surface Speed
P4300A90	-65°F to +275°F (-54°C to +135°C)	5,000 psi (344 bar)	< 1.6 ft/s (0.5 m/s)
P4301A90	-65°F to +275°F (-54°C to +135°C)	5000 psi (344 bar)	< 1.6 ft/s (0.5 m/s)
P4700A90	-65°F to +200°F (-54°C to +93°C)	5,000 psi (344 bar)	< 1.6 ft/s (0.5 m/s)
P5065A88	-70°F to +200°F (-57°C to +93°C)	3,500 psi (241 bar)	< 1.6 ft/s (0.5 m/s)

Alternate Materials: For applications that may require an alternate material, please contact your local Parker representative.

†**Pressure Range** without wear rings. If used with wear rings, see [Table 2-4, page 2-5](#).



B7 Cross-Section

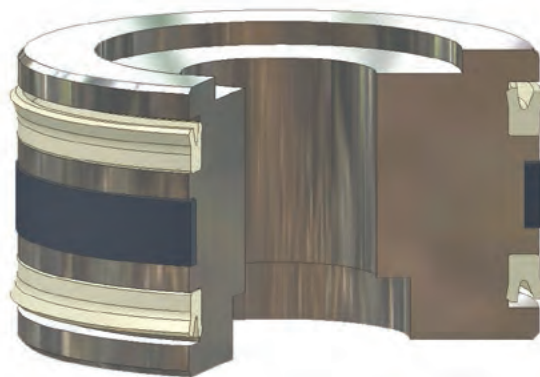

B7 installed in Piston Gland



Part Number Nomenclature – B7 Profile

Table 7-15. B7 Profile

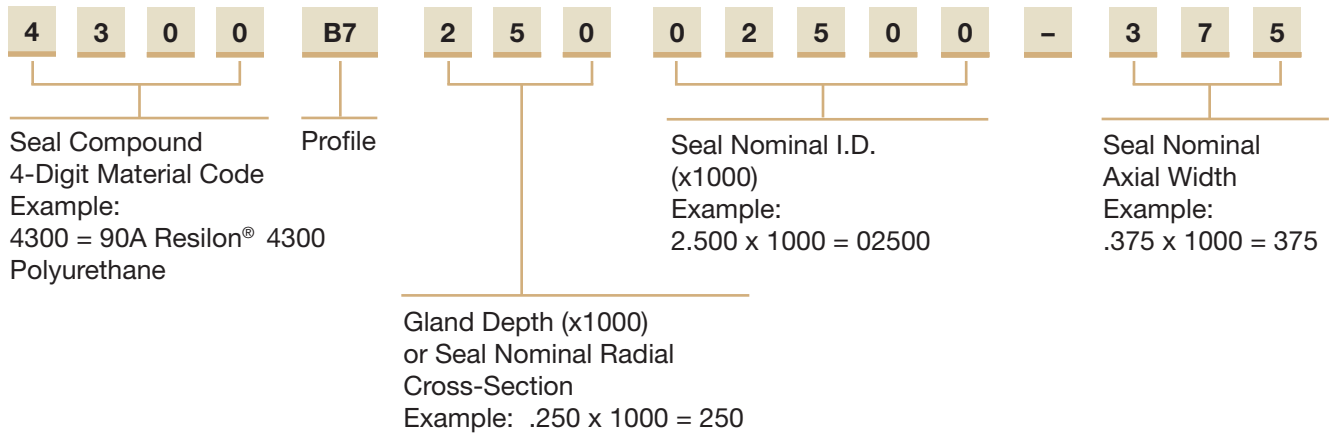

Gland Dimensions – B7 Profile

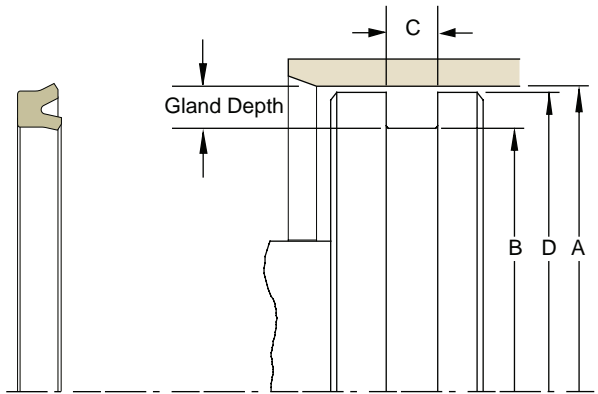

Please refer to Engineering [Section 2](#), [page 2-8](#) for surface finish and additional hardware considerations.

Table 7-16. B7 Profile – Piston Gland Calculation

A Bore Diameter		Seal		B Groove Diameter		C Groove Width	D Piston Diameter*	
Range	Tol.	Cross-Section	Axial Width	Calc.	Tol.	+0.015/-0.000	Calc.	Tol.
0.500 - 1.499	+0.002/-0.000	0.125	0.187	Dia. A - .250	+0.000/-0.002	0.206	Dia. A - .001	+0.000/-0.001
1.500 - 2.624	+0.002/-0.000	0.187	0.312	Dia. A - .375	+0.000/-0.002	0.343	Dia. A - .001	+0.000/-0.002
2.625 - 4.999	+0.003/-0.000	0.250	0.375	Dia. A - .500	+0.000/-0.003	0.413	Dia. A - .001	+0.000/-0.002
5.000 - 6.249	+0.003/-0.000	0.312	0.562	Dia. A - .625	+0.000/-0.003	0.618	Dia. A - .001	+0.000/-0.002
6.250 - 9.999	+0.004/-0.000	0.375	0.625	Dia. A - .750	+0.000/-0.005	0.688	Dia. A - .002	+0.000/-0.002
10.000 - 16.000	+0.005/-0.000	0.500	0.750	Dia. A - 1.000	+0.000/-0.007	0.825	Dia. A - .002	+0.000/-0.003

* If used with wear rings, refer to wear ring piston diameter, see [Section 9](#). For custom groove calculations, see [Appendix C](#).

Above table reflects recommended cross-sections for bore diameters shown. Alternate cross-sections and additional sizes may be considered. Consult www.parker.com/eps/FluidPower for hardware specifications, additional cross-sections and sizes, and part number availability. Contact your Parker representative for assistance.

Piston Seal

UP Profile

Catalog EPS 5370/USA

UP Profile, Industrial U-cup Piston Seal

The UP profile is a non-symmetrical, hydraulic piston seal. The knife trimmed, beveled lip faces the bore to provide enhanced low to high pressure sealing and wiping action. The UP profile is a uni-directional seal. Two UP seals can be used, back to back, in separate grooves to provide bi-directional pressure sealing. The UP profile is an economical choice, available in Parker's wear resistant and extrusion resistant Molythane® compound.



Technical Data

Standard Materials	Temperature Range	Pressure Range†	Surface Speed
P4615A90	-65°F to +200°F (-54°C to +93°C)	5,000 psi (344 bar)	< 1.6 ft/s (0.5 m/s)

Alternate Materials: For applications that may require an alternate material, please contact your local Parker representative.

†**Pressure Range** without wear rings. If used with wear rings, see [Table 2-4, page 2-5](#).



UP Cross-Section



UP installed in Piston Gland

* If used with wear rings, refer to wear ring piston diameter, see [Section 9](#). For custom groove calculations, see [Appendix C](#). Above table reflects recommended cross-sections for bore diameters shown. Alternate cross-sections and additional sizes may be considered. Consult www.parker.com/eps/FluidPower for hardware specifications, additional cross-sections and sizes, and part number availability. Contact your Parker representative for assistance.

Range	Tol.	Cross-Section	Seal	Groove Diameter		Tol.	Calc.	Bore Diameter	Tol.
				Calc.	Tol.				
0.500 - 1.499	+0.02/-0.000	0.125	0.187	Dia. A - .250	+0.00/-0.002	0.206	Dia. A - .001	+0.00/-0.001	
1.500 - 2.624	+0.02/-0.000	0.187	0.312	Dia. A - .375	+0.00/-0.002	0.343	Dia. A - .001	+0.00/-0.002	
2.625 - 4.999	+0.03/-0.000	0.250	0.375	Dia. A - .500	+0.00/-0.003	0.413	Dia. A - .001	+0.00/-0.002	
5.000 - 6.249	+0.03/-0.000	0.312	0.562	Dia. A - .625	+0.00/-0.003	0.618	Dia. A - .001	+0.00/-0.002	
6.250 - 9.999	+0.04/-0.000	0.375	0.625	Dia. A - .750	+0.00/-0.005	0.688	Dia. A - .002	+0.00/-0.002	
10.000 - 16.000	+0.05/-0.000	0.500	0.750	Dia. A - 1.000	+0.00/-0.007	0.825	Dia. A - .002	+0.00/-0.003	

Table 7-18. UP Profile – Piston Gland Calculation

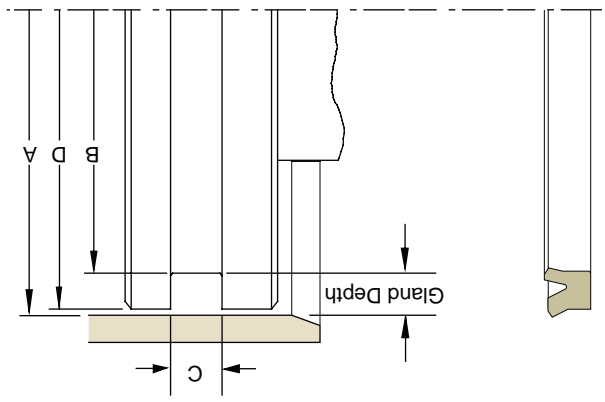

Please refer to Engineering [Section 2](#), [page 2-8](#) for surface finish and additional hardware considerations.

Gland Dimensions – UP Profile

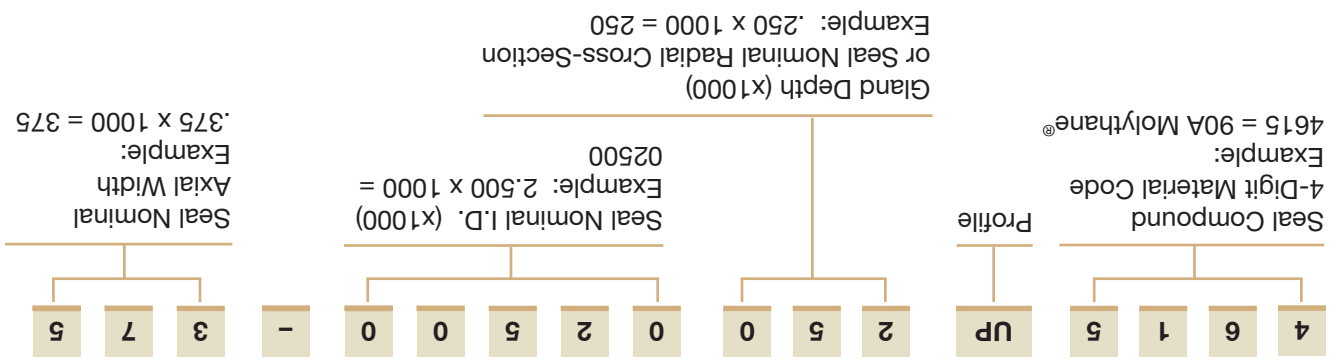

Part Number Nomenclature – UP Profile

Piston Seal

E4 Profile

Catalog EPS 5370/USA



E4 Profile, Rounded Lip Pneumatic U-cup Piston Seal

Parker's E4 profile is a non-symmetrical piston seal designed to seal both lubricated and non-lubricated air. To ensure that critical surfaces retain lubrication, the radius edge of the lip is designed to hydroplane over pre-lubricated surfaces. The standard compound for the E4 profile is Parker proprietary Nitroxile® Extreme Low Friction ("ELF") compound N4274A85. This compound is formulated with proprietary internal lubricants to provide extreme low friction and excellent wear resistance. This compound provides extended cycle life over standard nitrile and carboxylated nitrile compounds.

Technical Data

Standard Materials	Temperature Range	Pressure Range†	Surface Speed
N4274A85	-10°F to +250°F (-23°C to +121°C)	250 psi (17 bar)	< 3 ft/s (1 m/s)
N4180A80	-40°F to +250°F (-40°C to +121°C)	250 psi (17 bar)	< 3 ft/s (1 m/s)
V4208A90	-5°F to +400°F (-21°C to +204°C)	250 psi (17 bar)	< 3 ft/s (1 m/s)
P5065A88	-70°F to +200°F (-57°C to +93°C)	250 psi (17 bar)	< 3 ft/s (1 m/s)

Alternate Materials: For applications that may require an alternate material, please contact your local Parker representative.

†**Pressure Range** without wear rings. If used with wear rings, see [Table 2-4, page 2-5](#).



E4 Cross-Section



E4 installed in Piston Gland

* If used with wear rings, refer to wear ring piston diameter, see [Section 9](#). For custom groove calculations, see [Appendix C](#). Above table reflects recommended cross-sections for bore diameters shown. Alternate cross-sections and additional sizes may be considered. Consult www.parker.com/eps/FluidPower for hardware specifications, additional cross-sections and sizes, and part number availability. Contact your Parker representative for assistance.

Bore Diameter A	Cross-Section Tol.	Seal Axial Width	Groove Diameter Calc.	Groove Diameter Tol.	Grove Width Calc.	Piston Diameter* D	Range
							+
0.625 - 1.249	+0.002/-0.000	0.125	Dia. A - .250	+0.000/-0.002	0.156	Dia. A - .001	+0.000/-0.001
1.250 - 1.749	+0.002/-0.000	0.156	Dia. A - .313	+0.000/-0.002	0.188	Dia. A - .002	+0.000/-0.002
1.750 - 2.624	+0.002/-0.000	0.187	Dia. A - .375	+0.000/-0.003	0.219	Dia. A - .002	+0.000/-0.002
2.625 - 3.499	+0.002/-0.000	0.218	Dia. A - .438	+0.000/-0.003	0.250	Dia. A - .002	+0.000/-0.002
3.500 - 3.249	+0.003/-0.000	0.250	Dia. A - .500	+0.000/-0.005	0.281	Dia. A - .002	+0.000/-0.003
5.250 - 6.249	+0.003/-0.000	0.281	Dia. A - .563	+0.000/-0.007	0.312	Dia. A - .002	+0.000/-0.003
6.250 - 9.499	+0.003/-0.000	0.312	Dia. A - .625	+0.000/-0.007	0.344	Dia. A - .002	+0.000/-0.003
9.500 - 10.000	+0.004/-0.000	0.343	Dia. A - .688	+0.000/-0.007	0.375	Dia. A - .002	+0.000/-0.003

Table 7-20. E4 Profile – Piston Gland Calculation

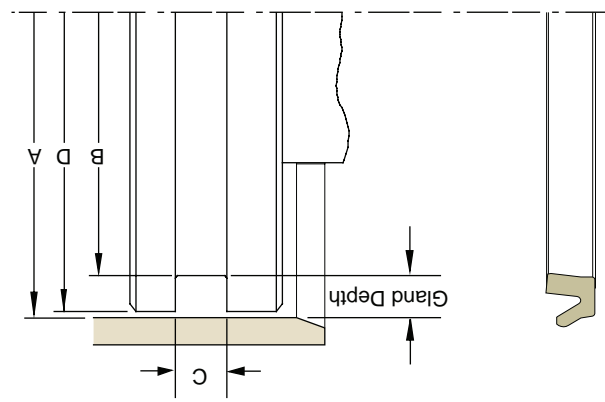

Please refer to Engineering [Section 2](#), [page 2-8](#) for surface finish and additional hardware considerations.

Gland Dimensions – E4 Profile

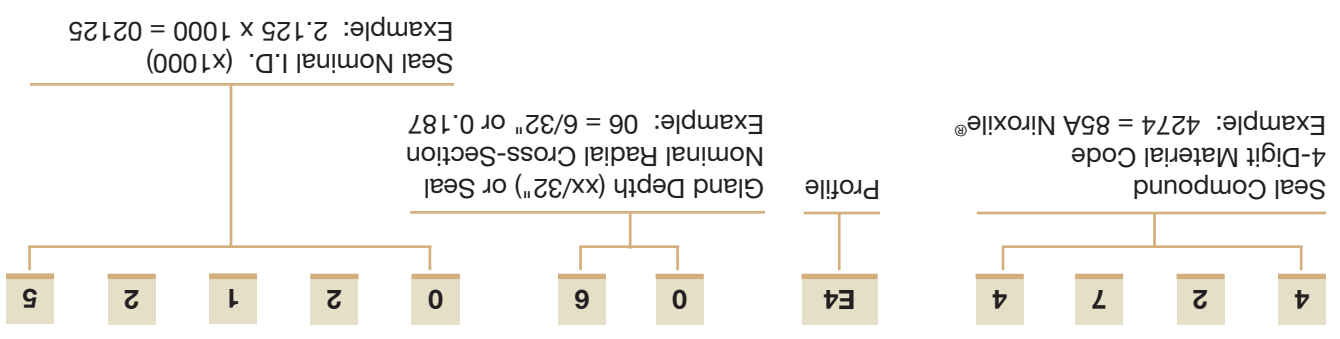

Part Number Nomenclature – E4 Profile

Piston Seal

BMP Profile

Catalog EPS 5370/USA

BMP Profile, Rounded Lip Seal with Bumper Cushion

The Parker BMP profile is a low friction bumper and seal providing quiet deceleration and reduced end stroke noise in pneumatic piston applications. Designed to mount on the ends of the piston and to be used along with Parker's V6 profile cushion seal, the bumper pad absorbs the final inertia which prevents contact between the piston and tube ends. The BMP profile can also be used without cushion seals in less critical applications. The BMP profile has a rounded sealing edge which hydroplanes over pre-lubricated surfaces extending cycle life and reducing friction. The BMP profile is available in Parker's proprietary Nitroxile® compound, offering low friction and wear resistance, as well as fluorocarbon for extended temperature range.



Technical Data

Standard Materials	Temperature Range	Pressure Range†	Surface Speed
N4283A75	-10°F to +250°F (-23°C to +121°C)	250 psi (17 bar)	< 3 ft/s (1 m/s)
N4274A85	-10°F to +250°F (-23°C to +121°C)	250 psi (17 bar)	< 3 ft/s (1 m/s)
V4208A90	-5°F to +400°F (-21°C to +204°C)	250 psi (17 bar)	< 3 ft/s (1 m/s)

Alternate Materials: For applications that may require an alternate material, please contact your local Parker representative.



BMP Cross-Section

†**Pressure Range** without wear rings. If used with wear rings, see [Table 2-4, page 2-5](#).



BMP installed in Piston Gland

Part Number Nomenclature – BMP Profile

Table 7-21. BMP Profile

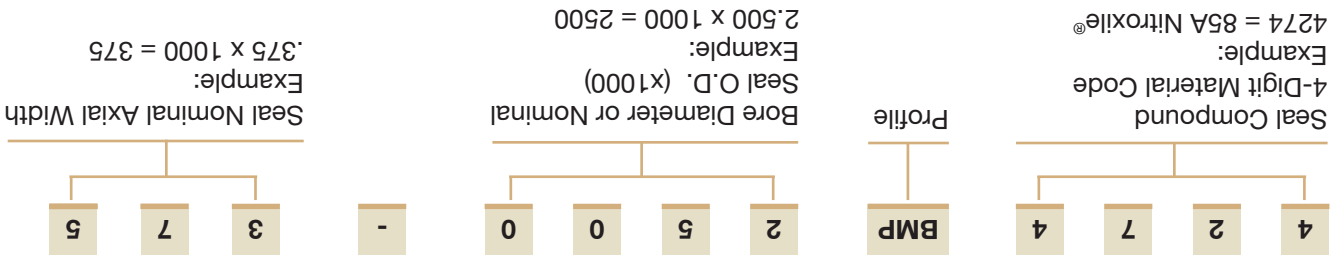

Gland Dimensions – BMP Profile

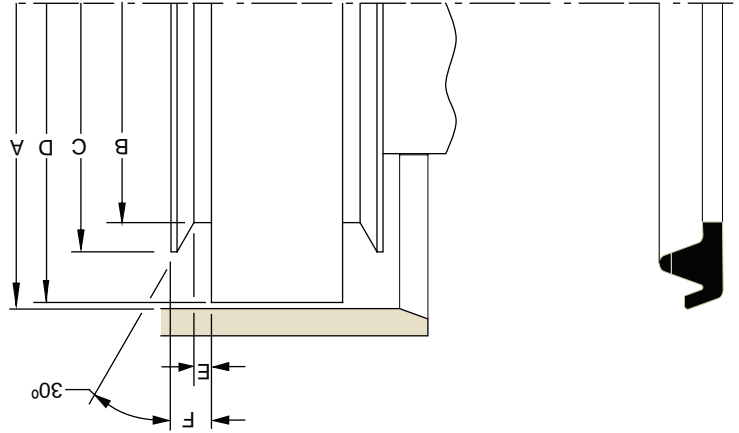

Please refer to Engineering Section 2, page 2-8 for surface finish and additional hardware considerations.

7

Table 7-22. BMP Profile – Piston Gland Dimensions

Example Part Number (Replace XXXX with respective material code)	F Shoulder Height	E Groove Width	D Piston Diameter*	C Shoulder Diameter	B Groove Diameter	A Bore Diameter
XXXXBMP125-312	+0.002/-0.000	+0.005/-0.002	+0.000/-0.005	+0.000/-0.005	+0.000/-0.005	+0.002/-0.000
XXXXBMP1125-312	0.204	0.110	1.123	0.851	0.639	1.125
XXXXBMP1500-312	0.256	0.138	1.498	1.050	0.810	1.500
XXXXBMP2000-312	0.256	0.138	1.998	1.440	1.202	2.000
XXXXBMP125-312	0.315	0.157	2.498	1.925	1.640	2.500
XXXXBMP3250-375	0.315	0.157	3.248	2.550	2.150	3.250
XXXXBMP4000-375	0.315	0.157	3.998	3.268	2.810	4.000
XXXXBMP5000-500	0.315	0.157	4.998	4.095	3.525	5.000

* If used with wear rings, refer to wear ring piston diameter, see Section 9. For custom groove calculations, see Appendix C. Above table reflects recommended cross-sections for bore diameters shown. Alternate cross-sections and additional sizes may be considered. Consult www.parker.com/eps/FluidPower for hardware specifications, additional cross-sections and sizes, and part number availability. Contact your Parker representative for assistance.



Piston Seal TP Profile

Catalog EPS 5370/USA

TP Profile (Piston T-seal), Compact Seal with Anti-Extrusion Technology



Parker's TP profile piston T-seal is designed to retrofit o-rings in no back-up, single back-up and two back-up standard industrial reciprocating o-ring glands. Its compact design provides improved stability and extrusion resistance in dynamic fluid sealing applications. The flange or base of the T-seal forms a tight seal in the gland and supports the anti-extrusion back-up rings. When energized, the back-up rings bridge the extrusion gap to protect the rubber sealing element from extrusion and system contamination. The T-seal geometry eliminates the spiral or twisting failure that can occur when o-rings are used against a dynamic surface. Parker offers the TP profile in a variety of elastomer and back-up ring compounds to cover a wide range of fluid compatibility, pressure and temperature.

Profile **TP0** for **no** back-up o-ring gland (standard offering)

Profile **TPS** for **single** back-up o-ring gland

Profile **TPT** for **two** back-up o-ring gland

The TP profile is sold only as an assembly (elastomer and back-up).

Technical Data

Standard Materials

Base

Elastomer
N4115A75
N4274A85
V4205A75
E4259A80

Temperature Range

-40°F to +225°F (-40°C to +107°C)
-10°F to +250°F (-23°C to +121°C)
-20°F to +400°F (-29°C to +204°C)
-65°F to +300°F (-54°C to +149°C)

Surface Speed

< 1.6 ft/s (0.5 m/s)
< 1.6 ft/s (0.5 m/s)
< 1.6 ft/s (0.5 m/s)
< 1.6 ft/s (0.5 m/s)



TP Cross-Section

Alternate Materials: For applications that may require an alternate material, please see [Section 3](#) for alternate elastomer materials.

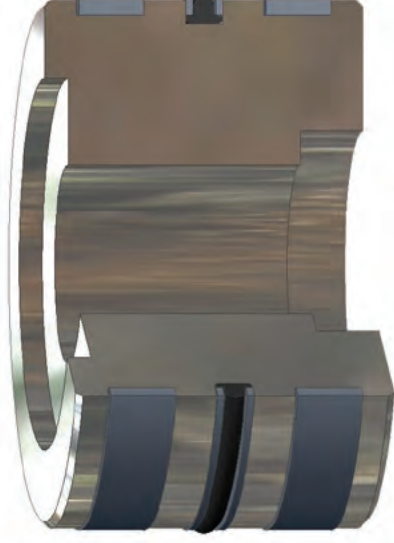

TP installed in Piston Gland

Technical Data (Continued)

Standard Materials

Back-up

Ring

B001 = 4655

B011 = Virgin PTFE

B085 = PEEK

Temperature Range

-65°F to +275°F (-54°C to +135°C)

-425°F to +450°F (-254°C to +233°C)

-65°F to +500°F (-54°C to +260°C)

Pressure Range†

5,000 psi (344 bar)

3,000 psi (206 bar)

10,000 psi (689 bar)

Alternate Materials: For applications that may require an alternate material, please see [Section 3](#) for T-seal back-up materials.

†**Pressure Range** without wear rings. If used with wear rings, see [Table 2-4, page 2-5](#).

Part Number Nomenclature – TP Profile (Piston T-seal)

Table 7-23. TP Profile

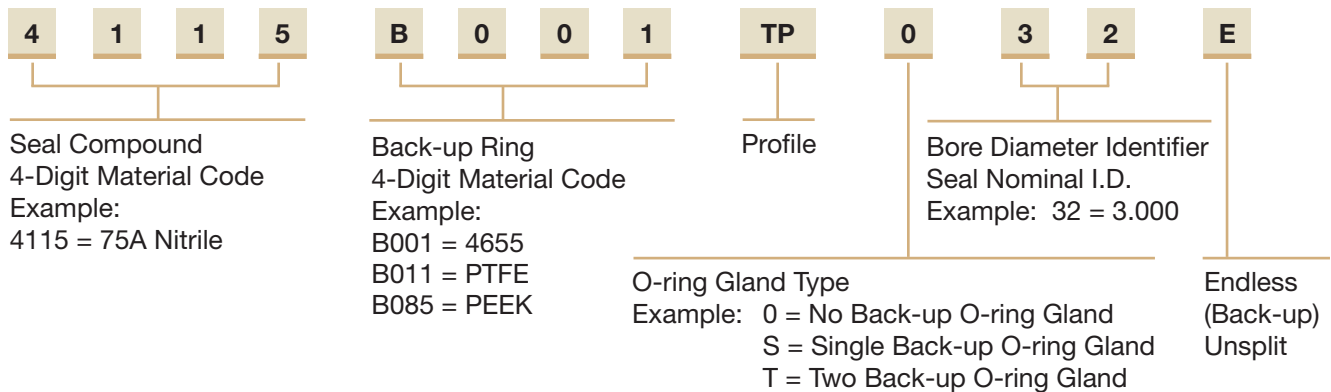

7

Gland Dimensions – TP Profile

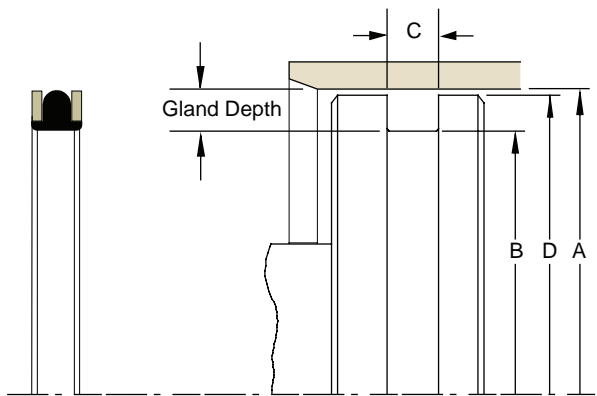

Please refer to Engineering [Section 2, page 2-8](#) for surface finish and additional hardware considerations.

Table 7-24. TP Profile — Piston Gland Calculation

A Bore Diameter Range	TP Profile Number	Ref: O-Ring Dash #	Gland Depth	B Groove Diameter	C TPO Groove Width	C TPS Groove Width	C TPT Groove Width	D Piston Diameter*
+ .002/- .000				+ .000/- .002	+ .005/- .000	+ .005/- .000	+ .005/- .000	+ .000/- .001
0.374 - 0.499	01 to 03	2-106 to 2-109	0.088	Dia. A - .176	0.140	0.171	0.238	Dia. A - .002
0.562 - 1.750	04 to 22	2-203 to 2-222	0.121	Dia. A - .242	0.187	0.208	0.275	Dia. A - .003
1.875 - 5.000	23 to 47	2-325 to 2-350	0.185	Dia. A - .370	0.281	0.311	0.410	Dia. A - .003
5.127 - 16.002	48 to 81	2-426 to 2-463	0.237	Dia. A - .474	0.375	0.408	0.538	Dia. A - .004

* If used with wear rings, refer to wear ring piston diameter, see [Section 9](#). For custom groove calculations, see [Appendix C](#).

Above table reflects recommended cross-sections for bore diameters shown. Alternate cross-sections and additional sizes may be considered. Consult www.parker.com/eps/FluidPower for hardware specifications, additional cross-sections and sizes, and part number availability. Contact your Parker representative for assistance.

Table 7-25. TP Profile — Bore Diameter Identifier Reference Table

TP Profile Number	Ref: O-Ring Dash #
01	106
02	108
03	109
04	203
05	204
06	205
07	206
08	207
09	208
10	209
11	210
12	211
13	212
14	213
15	214
16	215
17	216
18	217
19	218
20	219
21	220
22	222
23	325
24	326
25	327
26	328
27	329

TP Profile Number	Ref: O-Ring Dash #
28	330
29	331
30	332
31	333
32	334
33	335
34	336
35	338
36	339
37	340
38	341
39	342
40	343
41	344
42	345
43	346
44	347
45	348
46	349
47	350
48	426
49	427
50	428
51	429
52	430
53	431
54	432

TP Profile Number	Ref: O-Ring Dash #
55	433
56	434
57	435
58	437
59	438
60	439
61	440
62	441
63	442
64	443
65	444
66	445
67	446
68	447
69	448
70	449
71	450
72	451
73	452
74	453
75	454
76	455
77	456
78	457
79	458
80	459
81	460

Piston Seal S5 Profile

Catalog EPS 5370/USA

S5 Profile, Square PTFE Cap Seal



The Parker S5 profile is a bi-directional piston seal for use in low to medium duty hydraulic actuators and is suitable for sealing against hardened surfaces in pneumatic applications. The S5 profile is a two piece design comprised of a standard size Parker o-ring energizing a glass-filled PTFE cap. The S5 profile offers long wear, low friction and because of its short assembly length requires minimal gland space on the piston. The seal is commonly used in applications such as agriculture hydraulics, mobile hydraulics, machine tools, and hydraulic presses. Parker's S5 profile will retrofit non-Parker seals of similar design and is an updated version of the Parker S5000 piston seal.

The S5 profile may be ordered without the energizer by omitting the energizer code. [See part number nomenclature.](#)

Technical Data

Standard Materials	Temperature Range	Pressure Range†	Surface Speed
Cap 0203 15% Fiberglass filled PTFE	-200°F to +575°F (-129°C to +302°C)	3500 psi (241 bar)	< 13 ft/s (4 m/s)
Energizer A 70A Nitrile	-30°F to +250°F (-34°C to +121°C)		

Alternate Materials: For applications that may require an alternate material, please see [Section 3](#) for alternate PTFE ([Table 3-4](#)) and energizer ([Table 3-5](#)) materials.

†**Pressure Range** without wear rings. If used with wear rings, see [Table 2-4, page 2-5.](#)



Options

Split Rings: To aid in installation, the PTFE ring can be supplied in one of the following split configurations. To indicate that the S5 profile is to be split, add the appropriate split type indicator to the end of the part number.

- S = Step Cut
- T = Butt Cut
- V = Bevel cut

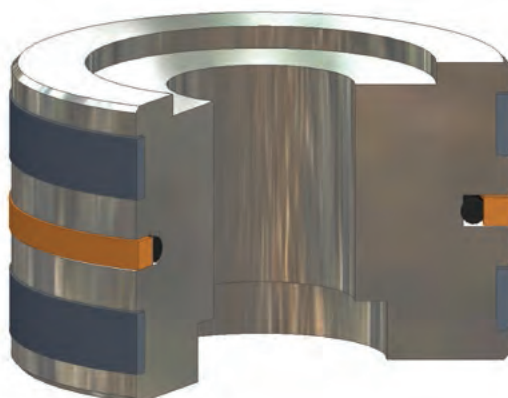

S5 installed in Piston Gland

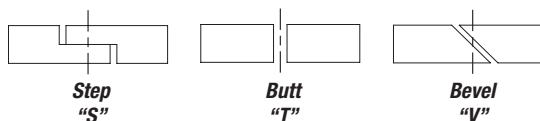

06/01/2014

Part Number Nomenclature – S5 Profile

Table 7-26. S5 Profile

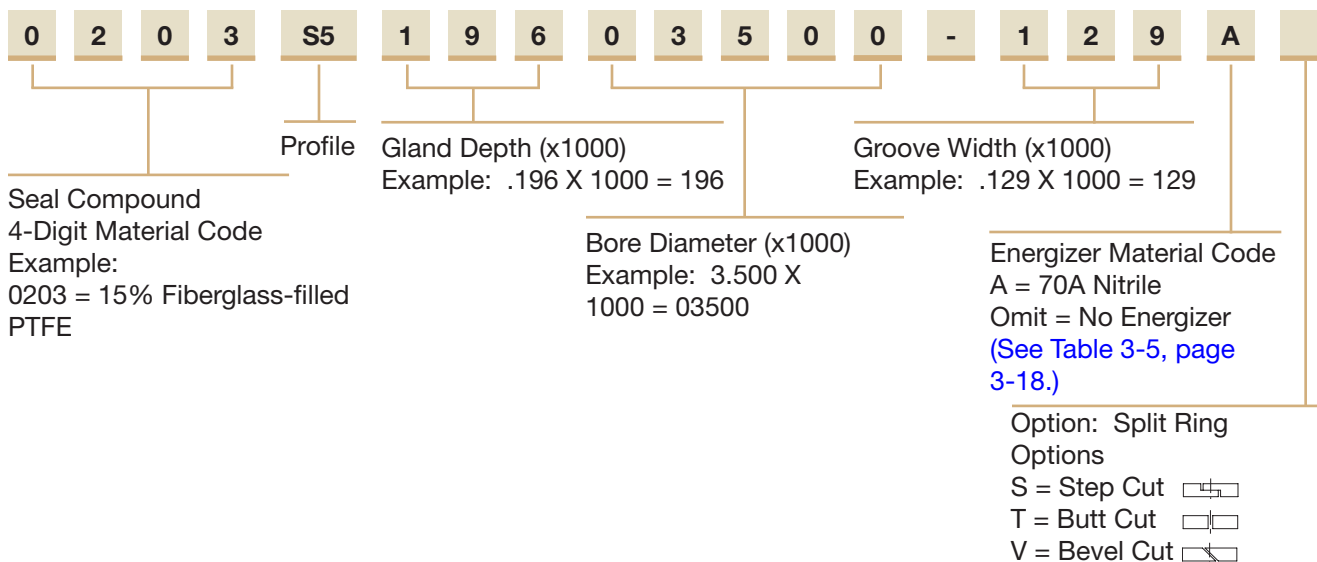

Gland Dimensions – S5 Profile

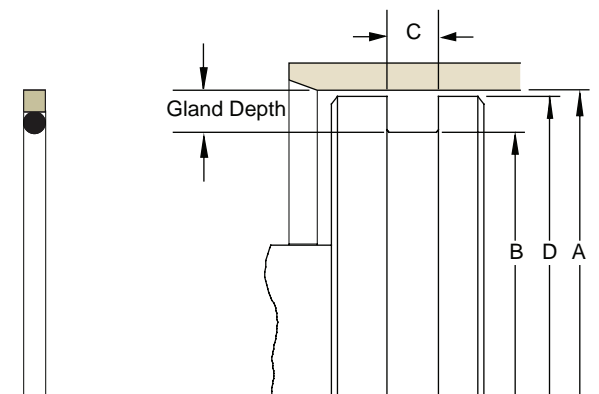

Please refer to Engineering Section 2, page 2-8 for surface finish and additional hardware considerations.



Table 7-27. S5 Profile – Piston Gland Calculation

A Bore Diameter		Gland Depth	B Groove Diameter		C Groove Width		D Piston Diameter*	
Range	Tol		Calc.	Tol	Width	Tol	Calc.	Tol.
0.500 - 1.500	+.002/-.000	0.130	Dia. A - .260	+.001/-.001	0.083	+.001/-.001	Dia. A - .001	+.000/-.002
1.625 - 1.875	+.002/-.000	0.196	Dia. A - .392	+.002/-.002	0.122	+.002/-.002	Dia. A - .001	+.000/-.002
2.000 - 5.500	+.003/-.000	0.196	Dia. A - .392	+.002/-.002	0.130	+.002/-.002	Dia. A - .001	+.000/-.003
5.750 - 16.000	+.003/-.000	0.259	Dia. A - .518	+.003/-.003	0.160	+.003/-.003	Dia. A - .002	+.000/-.003

* If used with wear rings, refer to wear ring piston diameter, see Section 9. For custom groove calculations, see Appendix C.

Above table reflects recommended cross-sections for Bore diameters shown. Alternate cross-sections and additional sizes may be considered. Consult www.parker.com/eps/FluidPower for hardware specifications, additional cross-sections and sizes, corresponding o-ring dash number, and part number availability. Contact your Parker representative for assistance.

Piston Seal R5 Profile

Catalog EPS 5370/USA

R5 Profile, Rectangular PTFE Cap Seal



The Parker R5 profile is a bi-directional piston seal for use in medium to heavy duty hydraulic actuators and is suitable for sealing against hardened surfaces in pneumatic applications. The R5 profile is a two piece design comprised of a standard size rubber square ring energizing a rectangular shaped PTFE cap. The R5 profile offers excellent stability, long wear, low friction and extrusion protection. The seal is commonly used in applications such as agriculture hydraulics, mobile hydraulics, machine tools and hydraulic presses. Parker's R5 profile will retrofit non-Parker seals of similar design and is an updated version of the Parker R5100 piston seal.

The R5 profile may be ordered without the energizer by omitting the energizer code. [See part number nomenclature.](#)

Technical Data

Standard Materials	Temperature Range	Pressure Range†	Surface Speed
Cap			
0203 15% Fiberglass filled PTFE	-200°F to +575°F (-129°C to +302°C)	3500 psi (241 bar)	< 13 ft/s (4 m/s)
Energizer			
A 70A Nitrile	-30°F to +250°F (-34°C to +121°C)		

Alternate Materials: For applications that may require an alternate material, please see [Section 3](#) for alternate PTFE ([Table 3-4](#)) and energizer ([Table 3-5](#)) materials.

†Pressure Range without wear rings. If used with wear rings, see [Table 2-4, page 2-5.](#)



R5 Cross-Section

Options

Split Rings: To aid in installation, the PTFE ring can be supplied in one of the following split configurations. To indicate that the R5 profile is to be split, add the appropriate split type indicator to the end of the part number.

- S = Step Cut
- T = Butt Cut
- V = Bevel cut

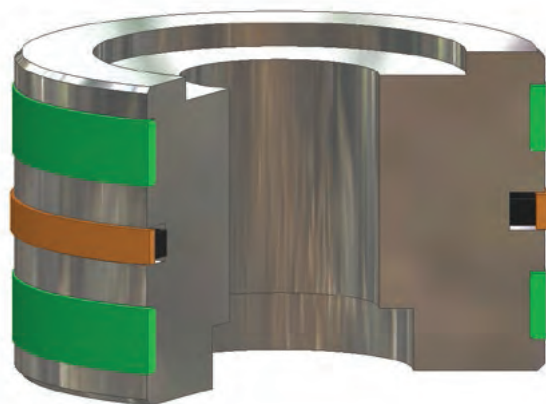
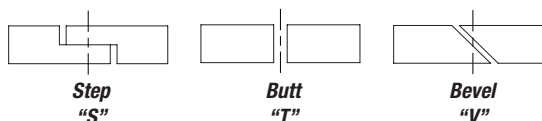



R5 installed in Piston Gland

06/01/2014

Part Number Nomenclature – R5 Profile

Table 7-28. R5 Profile

0	2	0	3	R5	2	8	0	0	5	0	0	0	-	2	8	4	A	
Seal Compound 4-Digit Material Code Example: 0203 = 15% Fiberglass-filled PTFE				Profile	Gland Depth (x1000) Example: .280 X 1000 = 280			Bore Diameter (x1000) Example: 5.000 X 1000 = 05000				Groove Width (x1000) Example: .284 X 1000 = 284			Energizer Material Code A = 70A Nitrile Omit = No Energizer			
Option: Split Ring																		
Options																		
S = Step Cut																		
T = Butt Cut																		
V = Bevel Cut																		

Gland Dimensions – R5 Profile

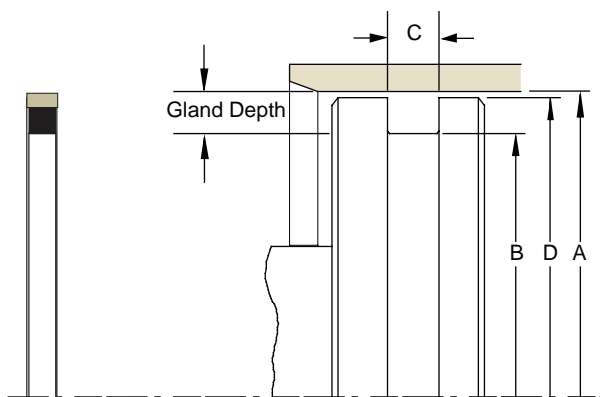

Table 7-29. R5 Profile – Piston Gland Calculation

A Bore Diameter		Gland Depth	B Groove Diameter		C Groove Width		D Piston Diameter*	
Range	Tol		Calc.	Tol	Width	Tol	Calc.	Tol.
1.000 - 2.750	+0.002/-0.000	0.155	Dia. A - .310	+0.001/-0.001	0.129	+0.002/-0.002	Dia. A - .001	+0.000/-0.001
3.000 - 5.000	+0.003/-0.000	0.280	Dia. A - .560	+0.002/-0.002	0.284	+0.003/-0.003	Dia. A - .002	+0.000/-0.002
5.250 - 8.500	+0.004/-0.000	0.381	Dia. A - .762	+0.003/-0.003	0.379	+0.004/-0.004	Dia. A - .003	+0.000/-0.003
9.000 - 14.000	+0.004/-0.000	0.439	Dia. A - .878	+0.004/-0.004	0.379	+0.004/-0.004	Dia. A - .004	+0.000/-0.004

* If used with wear rings, refer to wear ring piston diameter, see Section 9. For custom groove calculations, see Appendix C.

Above table reflects recommended cross-sections for Bore diameters shown. Alternate cross-sections and additional sizes may be considered. Consult www.parker.com/eps/FluidPower for hardware specifications, additional cross-sections and sizes, corresponding square ring number and part number availability. Contact your Parker representative for assistance.

Piston Seal CQ Profile

Catalog EPS 5370/USA

CQ Profile, Premium PTFE Cap Seal with Anti-Drift Technology



The Parker CQ profile is a bi-directional piston seal for use in medium to heavy duty hydraulic applications. The CQ profile is a unique seal design that includes a rubber quad seal in the PTFE cap to ensure drift free performance. The PTFE cap is a stable rectangular shape and is energized, depending on its cross section, by a single square energizer or dual Parker o-rings. The CQ piston seal is commonly used in applications such as mobile hydraulics, lift trucks, standard cylinders and piston accumulators. Parker's CQ profile will retrofit non-Parker seals of similar design.

The CQ profile may be ordered without the energizer and quad seal by omitting the energizer/quad seal code. [See part number nomenclature.](#)

Technical Data

Standard Materials	Temperature Range	Pressure Range†	Surface Speed
Cap 0401 40% bronze filled PTFE	-200°F to +575°F (-129°C to +302°C)	5000 psi (344 bar)	< 9.8 ft/s (3 m/s)
Energizer/Quad Seal A 70A Nitrile	-30°F to +250°F (-34°C to +121°C)		

Alternate Materials: For applications that may require an alternate material, please see [Section 3](#) for alternate PTFE ([Table 3-4](#)) and energizer ([Table 3-5](#)) materials.

†Pressure Range without wear rings. If used with wear rings, see [Table 2-4, page 2-5.](#)

Option

Notched Walls: Adding an “N” to the end of the part number indicates that notches are to be added to the side walls of the PTFE cap. Notches can help optimize the seal's response to fluid pressure. In application, the void created by the notch allows fluid pressure to fill the cavity between the side face of the gland and the seal. Consult your local Parker representative for the availability and cost to add side notches to the CQ profile.

N = Notched walls 

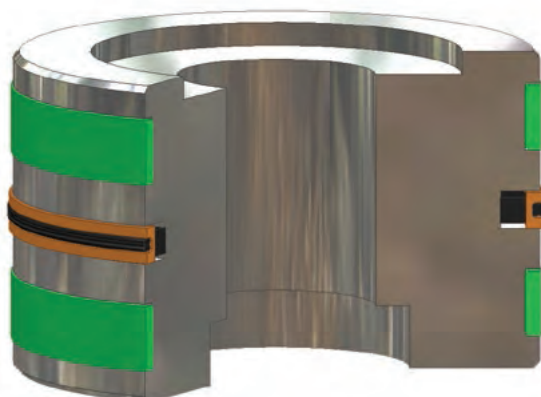
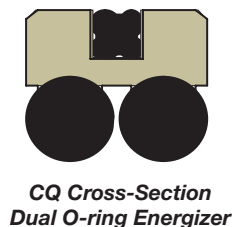
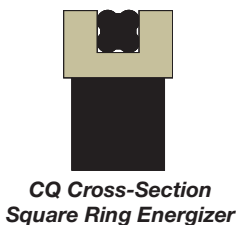

CQ installed in Piston Gland

06/01/2014

Part Number Nomenclature – CQ Profile

Table 7-30. CQ Profile

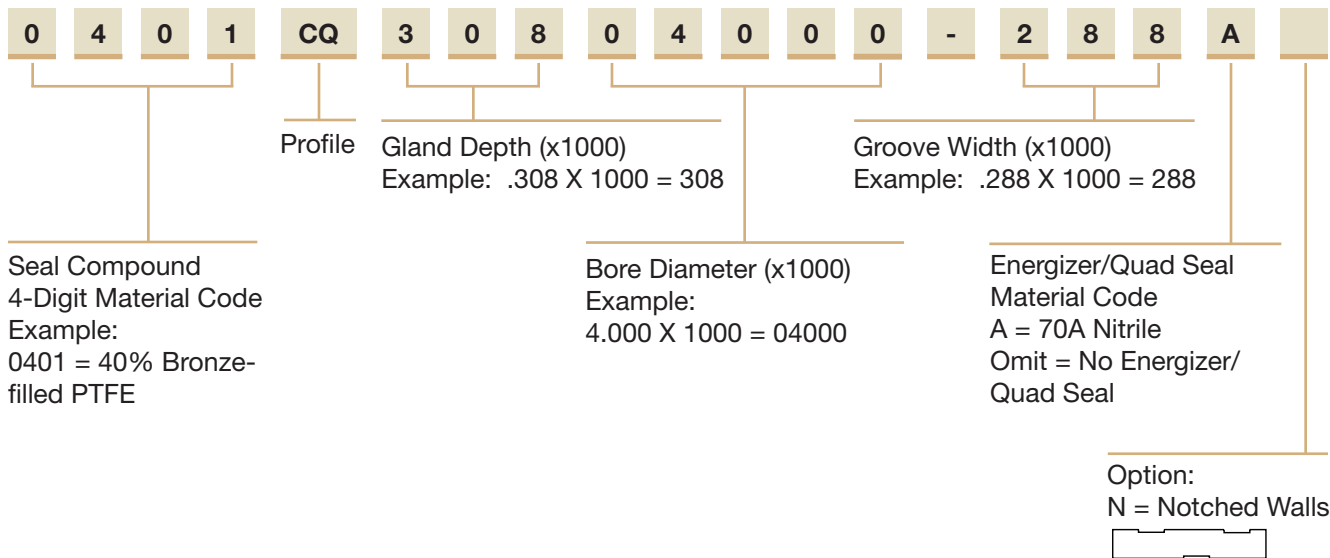

Gland Dimension – CQ Profile

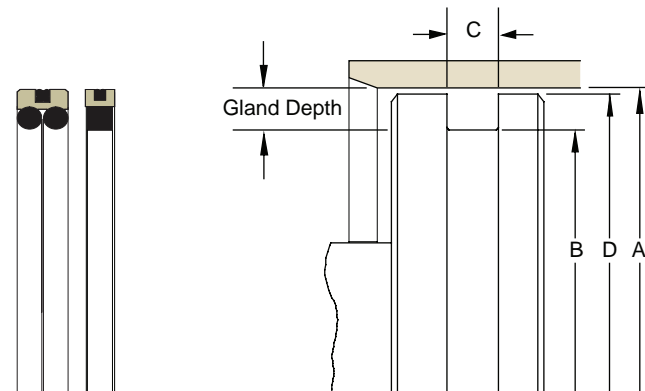

Please refer to Engineering Section 2, page 2-8 for surface finish and additional hardware considerations.



Table 7-31. CQ Profile – Piston Gland Calculation

A Bore Diameter		Gland Depth	B Groove Diameter		C Groove Width	D Piston Diameter*	
Range	Tol.		Calc.	Tol		Calc.	Tol
Square Ring Energizer							
1.500 - 4.999	+0.02/-0.00	0.308	Dia. A - .616	+0.00/-0.003	0.288	Dia. A - .001	+0.00/-0.002
5.000 - 10.000	+0.04/-0.00	0.420	Dia. A - .840	+0.00/-0.006	0.375	Dia. A - .002	+0.00/-0.004
Dual O-ring Energizer							
1.500 - 2.999	+0.02/-0.00	0.197	Dia. A - .394	+0.00/-0.003	0.248	Dia. A - .001	+0.00/-0.002
3.000 - 4.999	+0.02/-0.00	0.256	Dia. A - .512	+0.00/-0.003	0.375	Dia. A - .002	+0.00/-0.002
5.000 - 11.999	+0.04/-0.00	0.354	Dia. A - .708	+0.00/-0.006	0.484	Dia. A - .002	+0.00/-0.004
12.000 - 20.000	+0.06/-0.00	0.610	Dia. A - 1.220	+0.00/-0.008	0.642	Dia. A - .002	+0.00/-0.006

* If used with wear rings, refer to wear ring piston diameter, see Section 9.

Above table reflects recommended cross-sections for bore diameters shown. Alternate cross-sections and additional sizes may be considered. Consult www.parker.com/eps/FluidPower for hardware specifications, additional cross-sections and sizes, corresponding quad seal dash number, square ring number, and part number availability. Contact your Parker representative for assistance.

Piston Seal OE Profile

Catalog EPS 5370/USA

OE Profile, PTFE Piston Cap Seal



The Parker OE profile is a bi-directional piston seal for use in low to medium duty hydraulic applications. The OE profile is a two piece design comprised of a standard size Parker o-ring energizing a wear resistant PTFE cap. The OE profile offers long wear, low friction and because of its short assembly length requires minimal gland space on the piston. The seal is commonly used in applications such as mobile hydraulics, machine tools, injection molding machines and hydraulic presses. Parker's OE profile will retrofit non-Parker seals of similar design.

The OE profile may be ordered without the energizer by omitting the energizer code. [See part number nomenclature.](#)

Technical Data

Standard Materials*	Temperature Range	Pressure Range†	Surface Speed
Cap			
0401 40% bronze filled PTFE	-200°F to +575°F (-129°C to +302°C)	5000 psi (344 bar)	< 13 ft/s (4 m/s)
Energizer			
A 70A Nitrile	-30°F to +250°F (-34°C to +121°C)		

***Alternate Materials:** For applications that may require an alternate material, please see [Section 3](#) for alternate PTFE ([Table 3-4](#)) and energizer ([Table 3-5](#)) materials.

†Pressure Range without wear rings. If used with wear rings, see [Table 2-4, page 2-5.](#)

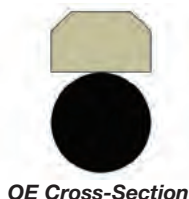

Option

Notched side walls: Adding an "N" to the end of the part number indicates that notches are to be added to the side walls of the PTFE cap. Notches can help optimize the seal's response to fluid pressure. In application, the void created by the notch allows fluid pressure to fill the cavity between the side face of the gland and the seal. Consult your local Parker seal representative for the availability and cost to add side notches to the OE profile.

N = Notched walls 

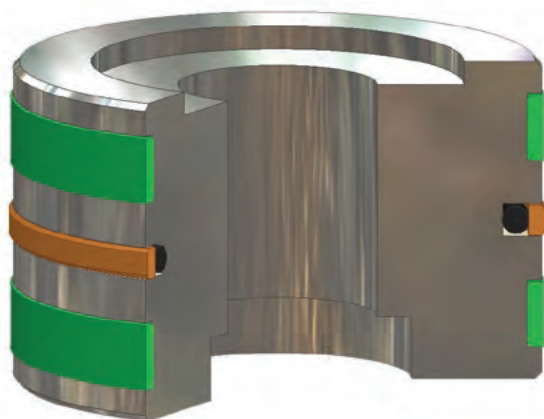

OE installed in Piston Gland

06/01/2014

Part Number Nomenclature – OE Profile

Table 7-32. OE Profile

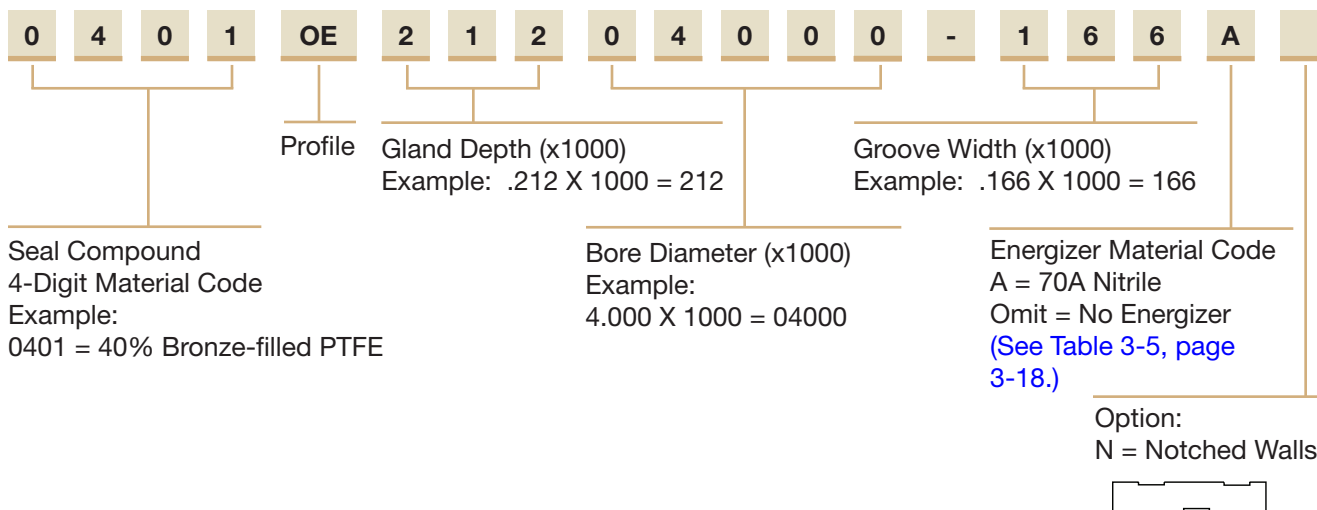

Gland Dimension – OE Profile

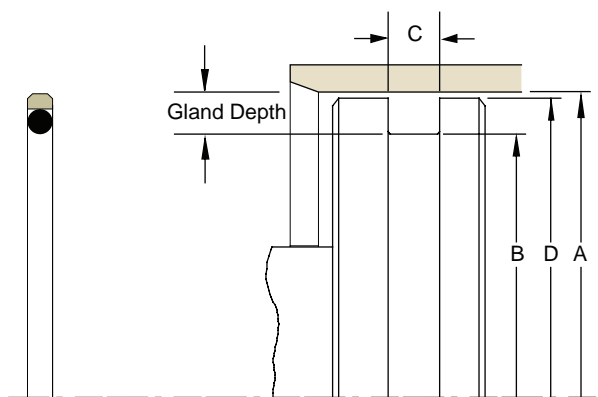

Please refer to Engineering Section 2, page 2-8 for surface finish and additional hardware considerations.



Table 7-33. OE Profile – Piston Gland Calculation

A Bore Diameter		Gland Depth	B Groove Diameter		C Groove Width	D Piston Diameter*	
Range	Tol		Calc.	Tol		Calc.	Tol.
0.500 - 1.000	+.001/-.000	0.087	Dia. A - .174	+.000/-.001	0.081	Dia. A - .001	+.000/-.002
0.750 - 1.500	+.002/-.000	0.126	Dia. A - .256	+.000/-.002	0.081	Dia. A - .001	+.000/-.002
1.000 - 2.500	+.002/-.000	0.149	Dia. A - .298	+.000/-.003	0.126	Dia. A - .001	+.000/-.002
2.000 - 5.500	+.003/-.000	0.212	Dia. A - .424	+.000/-.004	0.166	Dia. A - .001	+.000/-.003
3.500 - 10.000	+.004/-.000	0.308	Dia. A - .616	+.000/-.006	0.247	Dia. A - .002	+.000/-.003
7.000 - 16.000	+.005/-.000	0.415	Dia. A - .830	+.000/-.007	0.320	Dia. A - .002	+.000/-.004

* If used with wear rings, refer to wear ring piston diameter, see Section 9. For custom groove calculations, see Appendix C.

Above table reflects recommended cross-sections for bore diameters shown. Alternate cross-sections and additional sizes may be considered. Consult www.parker.com/eps/FluidPower for hardware specifications, additional cross-sections and sizes, corresponding o-ring dash number, and part number availability. Contact your Parker representative for assistance.

Piston Seal OG Profile

Catalog EPS 5370/USA



OG Profile, PTFE Piston Cap Seal

The Parker OG profile is a single-acting piston sealing set profile consisting of a PTFE piston sealing ring and an elastomer o-ring energizer. The asymmetrical cross-section of the slipper ring is designed for best drag oil performance during stroke in both directions. The OG profile is particularly suitable for single-acting pistons in control cylinders, in servo-controlled systems, machine tools, quick acting cylinders.

The material combination of the PTFE slipper ring and the elastomer o-ring make this product suitable for a wide range of applications, especially for aggressive media and/or high temperatures. The OG profile may be ordered without the energizer by omitting the energizer code. [See part number nomenclature.](#)

Technical Data

Standard Materials	Temperature Range	Pressure Range†	Surface Speed
Cap			
0401 40% Bronze-filled PTFE	-200°F to +575°F (-129°C to +302°C)	5000 psi (344 bar)	< 13 ft/s (4 m/s)
Energizer			
A 70A Nitrile	-30°F to +250°F (-34°C to +121°C)		

Alternate Materials: For applications that may require an alternate material, please see [Section 3](#) for alternate PTFE ([Table 3-4](#)) and energizer ([Table 3-5](#)) materials.

†**Pressure Range** without wear rings. If used with wear rings, see [Table 2-4, page 2-5.](#)

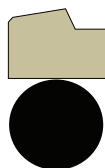

OG Cross-Section

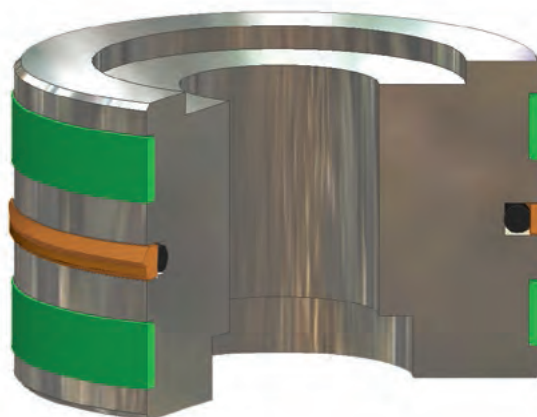

OG installed in Piston Gland

06/01/2014

Part Number Nomenclature – OG Profile

Table 7-34. OG Profile

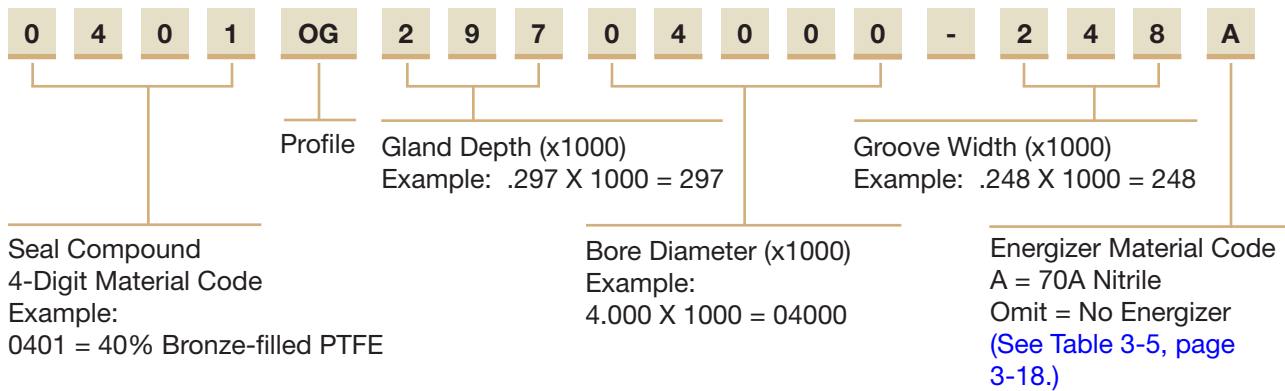

Gland Dimension – OG Profile

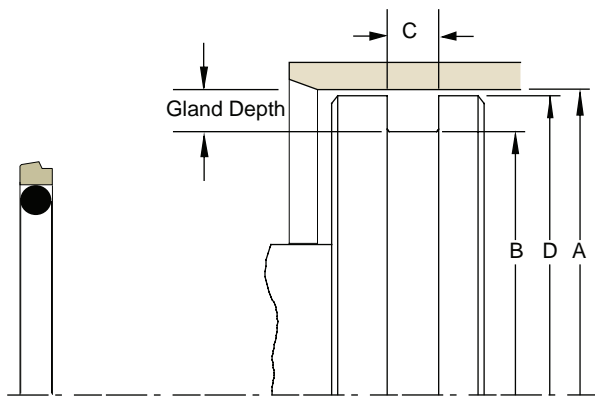

Please refer to Engineering Section 2, page 2-8 for surface finish and additional hardware considerations.



Table 7-35. OG Profile – Piston Gland Calculation

A Bore Diameter		Gland Depth	B Groove Diameter		C Groove Width	D Piston Diameter*		O-ring Series
Range	Tol		Calc.	Tol		Calc.	Tol.	
0.500 - 1.500	+0.002/-0.000	0.143	Dia. A - .286	+0.000/-0.002	0.126	Dia. A - .001	+0.000/-0.001	2-1xx
1.625 - 2.500	+0.002/-0.000	0.210	Dia. A - .420	+0.000/-0.002	0.165	Dia. A - .002	+0.000/-0.002	2-2xx
2.625 - 8.000	+0.003/-0.000	0.297	Dia. A - .594	+0.000/-0.004	0.248	Dia. A - .003	+0.000/-0.003	2-3xx
8.125 - 16.000	+0.005/-0.000	0.403	Dia. A - .806	+0.000/-0.005	0.319	Dia. A - .004	+0.000/-0.004	2-4xx

* If used with wear rings, refer to wear ring piston diameter, see Section 9. For custom groove calculations, see Appendix C.

Above table reflects recommended cross-sections for bore diameters shown. Alternate cross-sections and additional sizes may be considered. Consult www.parker.com/eps/FluidPower for hardware specifications, additional cross-sections and sizes, corresponding o-ring dash number, and part number availability. Contact your Parker representative for assistance.

Piston Seal CP Profile

Catalog EPS 5370/USA



CP Profile, PTFE Piston Cap Seal

The Parker CP profile is a cap seal with anti-extrusion, low friction and low wear features. The CP profile is a bi-directional piston seal for use in low to medium duty applications. Because of the unique design of the filled PTFE cap, the CP profile offers long wear, low friction and anti-extrusion. Only minimal gland space is needed to fit the seal on the piston due to its short assembly length.

The CP profile retrofits into a standard size o-ring groove without modification and will retrofit non-Parker seals of similar design. There are three CP profiles to match groove widths:

- CP0 — a standard o-ring groove
- CP1 — an o-ring groove designed for one back-up ring
- CP2 — an o-ring groove designed for two back-up rings

The CP profile may be ordered without the energizer by omitting the energizer code. [See part number nomenclature.](#)

Technical Data

Standard Materials	Temperature Range	Pressure Range†	Surface Speed
Cap			
0401 40% Bronze-filled PTFE	-200°F to +575°F (-129°C to +302°C)	3,500 psi (240 bar)	< 13 ft/s (4 m/s)
Energizer			
A 70A Nitrile	-30°F to +250°F (-34°C to +121°C)		



CP Cross-Section

Alternate Materials: For applications that may require an alternate material, please see [Section 3](#) for alternate PTFE ([Table 3-4](#)) and energizer ([Table 3-5](#)) materials.

†**Pressure Range** without wear rings. If used with wear rings, see [Table 2-4, page 2-5](#).

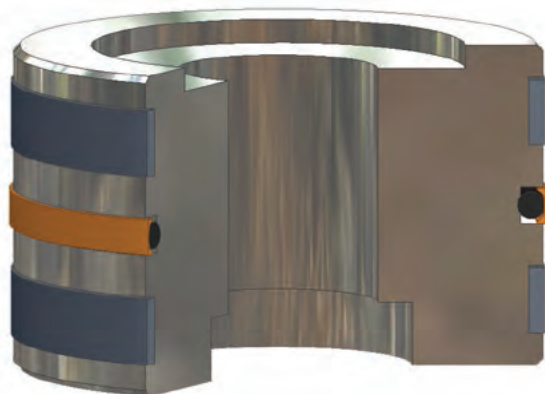

CP installed in Piston Gland

Option

Notched side walls: Adding an “N” to the end of the part number indicates that notches are to be added to the side walls of the PTFE cap. Notches can help optimize the seal’s response to fluid pressure. In application, the void created by the notch allows fluid pressure to fill the cavity between the side face of the gland and the seal. Consult your local Parker representative for the availability and cost to add side notches to the CP profile.

N = Notched walls 

06/01/2014

Part Number Nomenclature – CP Profile

Table 7-36. CP Profile

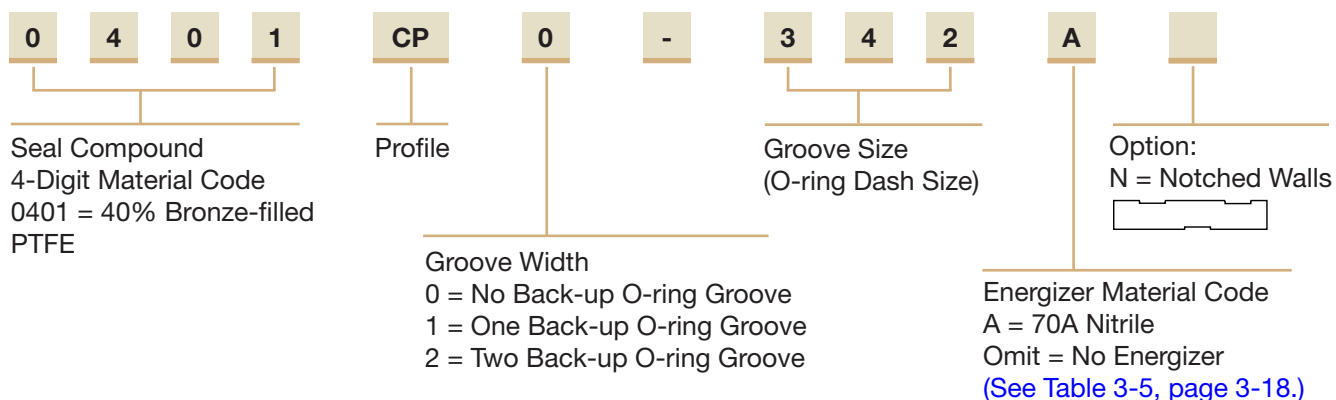

Gland Dimension – CP Profile

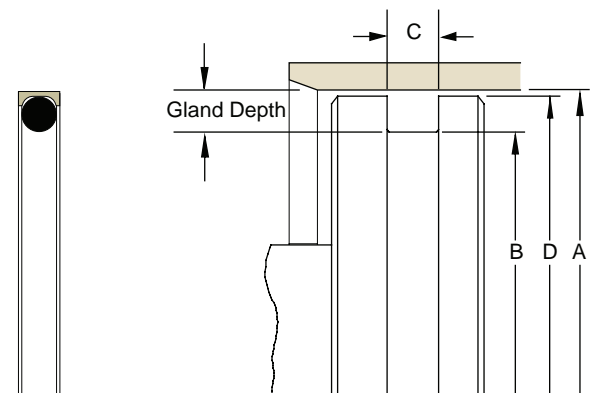

Please refer to Engineering Section 2, page 2-8 for surface finish and additional hardware considerations.



Table 7-37. CP Profile – Piston Gland Calculation

A Bore Diameter Range	O-Ring Dash #	B Groove Diameter	C CP0 Groove Width	C CP1 Groove Width	C CP2 Groove Width	D Piston Diameter*		O-Ring Series
						Calc.	Tol	
+0.002/ -0.000		+0.000/ -0.002	+0.005/ -0.000	+0.005/ -0.000	+0.005/ -0.000			
0.250 - 1.500	2-006 to 2-010	Dia. A - .110	0.093	0.138	0.205	Dia. A - .001	+0.000/-0.001	2-0xx
0.312 - 3.000	2-104 to 2-149	Dia. A - .176	0.140	0.171	0.238	Dia. A - .001	+0.000/-0.002	2-1xx
0.437 - 5.000	2-201 to 2-248	Dia. A - .242	0.187	0.208	0.275	Dia. A - .001	+0.000/-0.003	2-2xx
0.812 - 5.000	2-309 to 2-350	Dia. A - .370	0.281	0.311	0.410	Dia. A - .002	+0.000/-0.003	2-3xx
5.000 - 16.000	2-425 to 2-460	Dia. A - .474	0.375	0.408	0.538	Dia. A - .003	+0.000/-0.004	2-4xx

* If used with wear rings, refer to wear ring piston diameter, see Section 9.

Above table reflects recommended cross-sections for bore diameters shown. Alternate cross-sections and additional sizes may be considered. Consult www.parker.com/eps/FluidPower for hardware specifications, additional cross-sections and sizes, corresponding o-ring dash number, and part number availability. Contact your Parker representative for assistance.

Piston Seal OA Profile

Catalog EPS 5370/USA

OA Profile, Compact PTFE Piston Cap Seal



The Parker OA profile is a bi-directional piston seal for use in pneumatic and low- to medium-duty hydraulic applications. The OA profile is a two piece design utilizing a rectangular PTFE cap and standard size o-ring. The OA profile is an excellent choice for applications requiring a compact design. The unique properties of the modified PTFE provide added wear resistance for improved cycle life. Parker's OA profile will retrofit non-Parker seals of similar design.

The OA profile may be ordered without the energizer by omitting the energizer code. [See part number nomenclature.](#)

Technical Data

Standard Materials	Temperature Range	Pressure Range†	Surface Speed
Cap			
0102 Modified PTFE	-320°F to +450°F (-195°C to +282°C)	1,500 psi (103 bar)	< 13 ft/s (4 m/s)
Energizer			
A 70A Nitrile	-30°F to +250°F (-34°C to +121°C)		

Alternate Materials: For applications that may require an alternate material, please see [Section 3](#) for alternate PTFE and energizer materials.

†**Pressure Range** without wear rings. If used with wear rings, see [Table 2-4, page 2-5.](#)

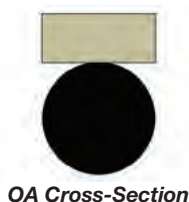

OA Cross-Section

Option

Notched side walls: Notches can be added to the side walls of the PTFE cap. This can help to optimize the seal's response to fluid pressure. Notched side walls help ensure that fluid pressure fills the cavity between the side face of the seal and the side face of the seal gland. Consult your local Parker representative for the availability and cost to add side notches to the OA profile.

N = Notched walls 

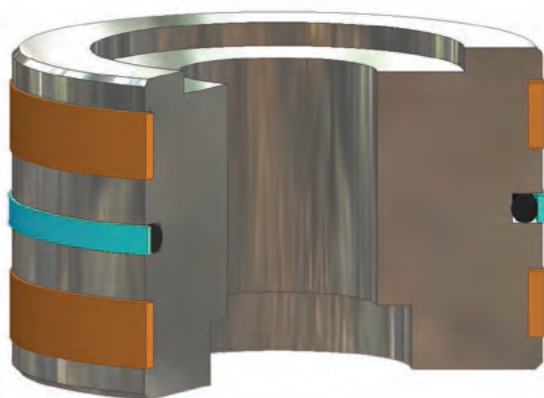

OA Installed in Piston Gland

06/01/2014

Part Number Nomenclature – OA Profile

Table 7-38. OA Profile

0	1	0	2	OA	1	8	2	0	3	0	0	0	-	1	4	9	A
Seal Compound 4-Digit Material Code Example: 0102 = Modified PTFE				Profile	Gland Depth (x1000) Example: .182 X 1000 = 182				Bore Diameter (x1000) Example: 3.000 X 1000 = 03000					Groove Width (x1000) Example: .149 X 1000 = 149			Energizer Material Code A = 70A Nitrile Omit = No Energizer (See Table 3-5, page 3-18.)
																	Option: N = Notched Walls

Gland Dimensions – OA Profile

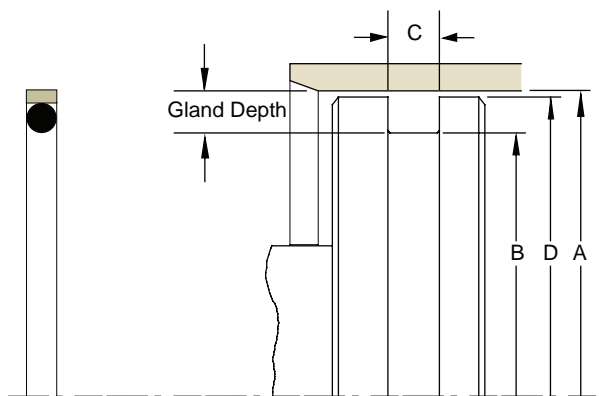

Please refer to Engineering Section 2, page 2-8 for surface finish and additional hardware considerations.



Table 7-39. OA Profile – Piston Gland Calculation

A Bore Diameter		Gland Depth	B Groove Diameter		C Groove Width +.005/-0.000	D Piston Diameter*		O-ring Dash Series
Range	Tol		Calc.	Tol		Calc.	Tol.	
0.281 - 0.375	+0.001/-0.000	0.071	Dia. A - .142	+0.000/-0.001	0.079	Dia. A - .004	+0.000/-0.001	2-0xx
0.437 - 1.500	+0.002/-0.000	0.087	Dia. A - .174	+0.000/-0.002	0.079	Dia. A - .005	+0.000/-0.001	2-0xx
0.625 - 3.000	+0.003/-0.000	0.119	Dia. A - .237	+0.000/-0.003	0.112	Dia. A - .005	+0.000/-0.002	2-1xx
1.062 - 5.000	+0.004/-0.000	0.182	Dia. A - .363	+0.000/-0.004	0.149	Dia. A - .006	+0.000/-0.002	2-2xx
2.000 - 5.000	+0.005/-0.000	0.246	Dia. A - .491	+0.000/-0.005	0.221	Dia. A - .007	+0.000/-0.002	2-3xx
5.125 - 6.500	+0.006/-0.000	0.297	Dia. A - .593	+0.000/-0.006	0.297	Dia. A - .008	+0.000/-0.002	2-4xx
6.750 - 8.500	+0.006/-0.000	0.359	Dia. A - .718	+0.000/-0.006	0.297	Dia. A - .008	+0.000/-0.002	2-4xx
9.000 - 16.000	+0.003/-0.000	0.484	Dia. A - .968	+0.000/-0.003	0.297	Dia. A - .008	+0.000/-0.002	2-4xx

* If used with wear rings, refer to wear ring piston diameter, see Section 9.

Above table reflects recommended cross-sections for bore diameters shown. Alternate cross-sections and additional sizes may be considered. Consult www.parker.com/eps/FluidPower for hardware specifications, additional cross-sections and sizes, corresponding o-ring dash number, and part number availability. Contact your Parker representative for assistance.

Piston Seal OQ Profile

Catalog EPS 5370/USA

OQ Profile, Rotary PTFE Cap Seal

The Parker OQ profile is a bi-directional piston seal for use in low to medium duty rotary or oscillating applications. The OQ profile is a two piece design comprised of a standard size o-ring energizing a wear resistant PTFE cap. The OQ profile offers long wear and low friction, without stickslip. The PTFE inner diameter is designed with a special interference with the o-ring to eliminate spinning between the o-ring and seal. Special grooves are designed into the PTFE outer diameter to provide lubrication and create a labyrinth effect for reduced leakage. Parker's OQ profile will retrofit non-Parker seals of similar design.

The OQ profile may be ordered without the energizer by omitting the energizer code. [See part number nomenclature.](#)

Technical Data

Standard Materials	Temperature Range	Pressure Range†	Surface Speed
Cap 0205 15% Fiberglass-, 5% MoS ₂ -filled PTFE	-200°F to +575°F (-129°C to +302°C)	3000 psi (206 bar)	< 3.3 ft/s (1.0 m/s)
Energizer A 70A Nitrile	-30°F to +250°F (-34°C to +121°C)		

Alternate Materials: For applications that may require an alternate material, please see [Section 3](#) for alternate PTFE ([Table 3-4](#)) and energizer ([Table 3-5](#)) materials.

†**Pressure Range** without wear rings. If used with wear rings, see [Table 2-4](#), [page 2-5](#).



OQ Cross-Section



OQ installed in Rotary Gland

Part Number Nomenclature — OQ Profile

Table 7-40. OQ Profile

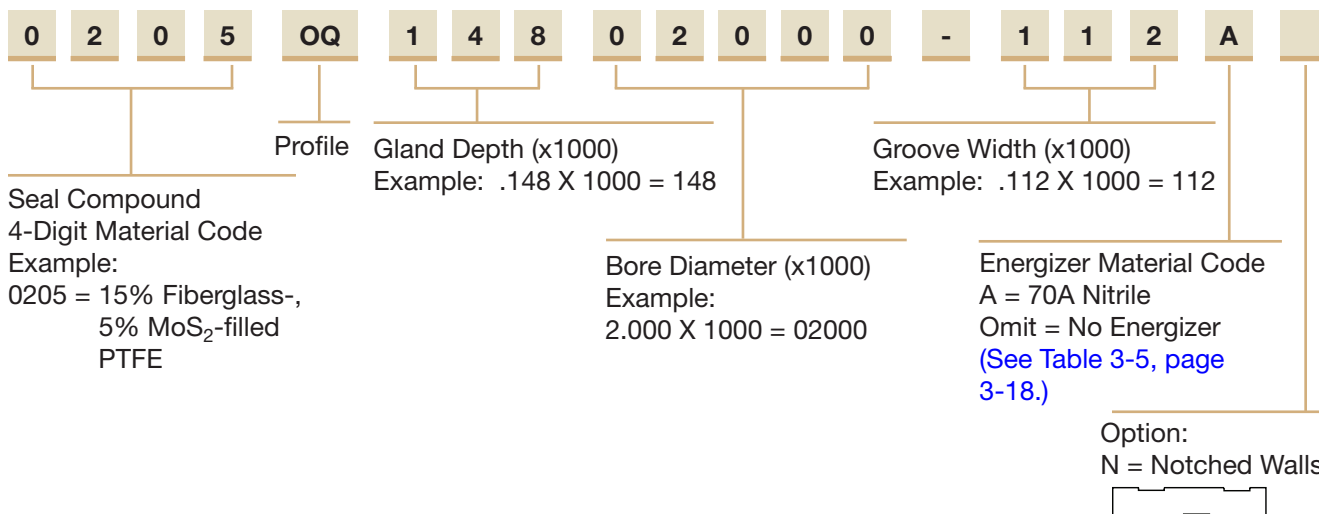

Gland Dimensions — OQ Profile

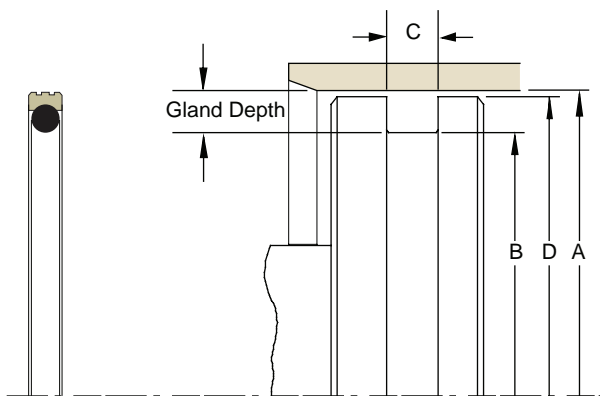

Please refer to Engineering Section 2, page 2-8 for surface finish and additional hardware considerations.



Table 7-41. OQ Profile — Piston Gland Calculation

A Bore Diameter		Gland Depth	B Groove Diameter		C Groove Width +.008/-.000	D Piston Diameter*		O-ring Dash Series
Range	Tol		Calc.	Tol		Calc.	Tol.	
0.375 - 0.437	+.001/-.000	0.097	Dia. A - .193	+.000/-.001	0.087	Dia. A - .001	+.000/-.002	2-0xx
0.438 - 1.499	+.002/-.000	0.097	Dia. A - .193	+.000/-.002	0.087	Dia. A - .001	+.000/-.002	2-0xx
1.500 - 2.999	+.003/-.000	0.148	Dia. A - .295	+.000/-.003	0.112	Dia. A - .001	+.000/-.002	2-1xx
3.000 - 5.999	+.004/-.000	0.217	Dia. A - .433	+.000/-.004	0.165	Dia. A - .001	+.000/-.003	2-2xx
6.000 - 11.999	+.005/-.000	0.305	Dia. A - .610	+.000/-.005	0.248	Dia. A - .002	+.000/-.004	2-3xx
12.000 - 20.000	+.006/-.000	0.414	Dia. A - .827	+.000/-.006	0.319	Dia. A - .002	+.000/-.005	2-4xx

* If used with wear rings, refer to wear ring piston diameter, see Section 9.

Above table reflects recommended cross-sections for bore diameters shown. Alternate cross-sections and additional sizes may be considered. Consult www.parker.com/eps/FluidPower for hardware specifications, additional cross-sections and sizes, and part number availability. Contact your Parker representative for assistance.

Wipers

Contents

Product Offering 8-3
 Decision Tree 8-4
 Wiper Profiles
 ◆ YD 8-5
 ◆ SHD 8-9
 SH959 8-13
 AH 8-15
 ◆ J 8-17
 ◆ AY 8-19
 H / 8600 8-22
 AD 8-24

Wiper Introduction

One of the primary causes of premature component failure in a fluid power system is contamination. Contaminants such as moisture, dirt, and dust can cause extensive damage to cylinder walls, rods, seals and other components. It has always been Parker's design philosophy to use aggressive wiping geometries to prevent the damage that is caused when trace amounts of dirt or water are allowed to enter a fluid power system. This philosophy goes hand in hand with reducing the down time and high costs associated with replacing rusted components, scored rods, filters and leaking seals.

Typical Hydraulic Cylinder

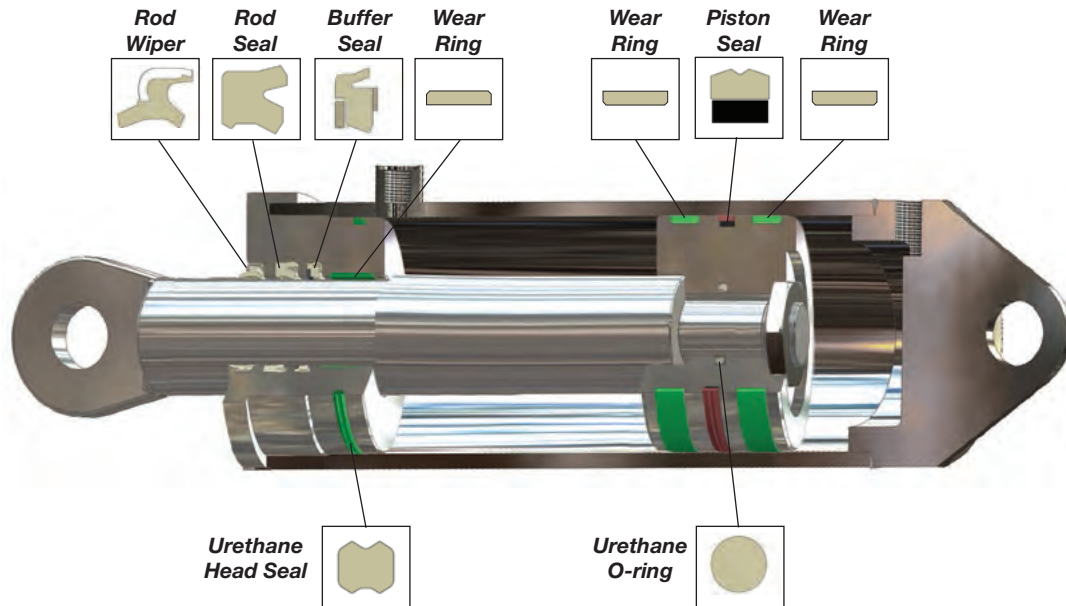

Choosing a Wiper

Some of the considerations that need to be made when choosing a wiper include:

1. Application Requirements
2. Groove Geometry
3. Lip Geometry
4. Redundant Sealing Lips
5. Environment
6. Rod Seal Interaction

Also see the Wiper Decision Tree found on [page 8-4](#).

1. **Application Requirements:** Whether hydraulic or pneumatic, high temperature, or low friction, Parker's broad range of materials and wiper profiles allow you to choose the right wiper for every application.
2. **Groove Geometry:** When choosing a wiper, the groove geometry, machining costs, wiper costs and the costs of replacing the wiper while in the field must be considered. The majority of mobile equipment manufacturers use press-fit canned wipers. While canned wipers are more costly, the gland machining costs are less and the wiper lips are more aggressive for this harsh environment.
3. **Lip Geometry:** Parker wipers are designed to give the best possible exclusion performance by featuring perpendicular, or "straight-cut" lip geometries. The footprint of a sharp, straight-cut wiper causes a high concentration of force which maximizes fluid film breakage while allowing contaminants to be pushed away from the wiping edge. (See Figure 8-1.) The footprint of a radiused lip, however, often results in a poor concentration of force. Although they are less costly, radiused lip geometries can trap contamination against the rod, lifting the wiper up and opening a gateway for further

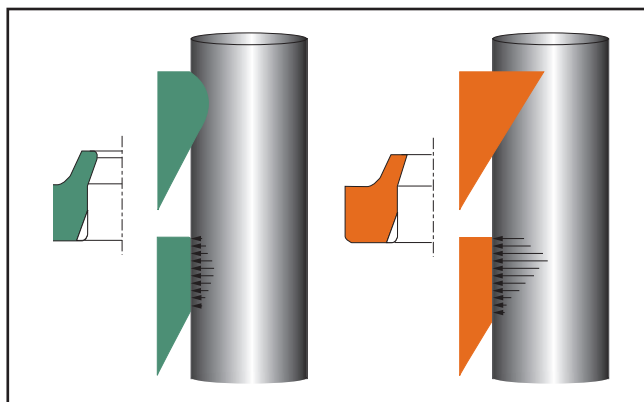

Figure 8-1. Radius vs. Straight Cut Lip Geometry

contamination. For ultimate performance, Parker offers profiles with a knife trimmed wiping lip. These profiles include the YD and J profiles.















4. **Redundant Sealing Lips:** One of the most effective ways to improve a system's sealing performance is to incorporate the use of multiple or redundant sealing lips. This can be accomplished by using Parker's AY, AH, H or 8600, double lip profiles. Because these wipers have a redundant sealing lip, there is no way for them to relieve a pressure trap out of the system. It is critical, therefore, to pair redundant lip wipers with the correct rod seals, such as the BT and B3 u-cup profiles. These rod seal profiles enable fluid pressure relief back into the system.
5. **Environment:** In certain applications where cylinders are in a vertical or rod-up orientation, it's possible for moisture or other contaminants to collect in the wiper gland. These situations can be found in everything from forklifts and agricultural cylinders to heavy duty construction equipment that is exposed to all-weather conditions. For this reason, Parker offers several wiper profiles that feature O.D. exclusion technology on both the dynamic and static surfaces to keep contamination out. For snap-in applications, the Parker YD profile offers an additional lip contact to exclude contamination at the O.D. For more aggressive sealing at the O.D., Parker offers the AH and J style metal encased wipers which utilize a metal to metal interference fit for high performance in harsh environments.
6. **Rod Seal Interaction:** It is important to properly pair rod seals and wiper combinations to minimize leakage. When the rod extends past the rod seal, there is a thin film of oil that remains trapped in microscopic surface imperfections. The thickness of this film depends on the aggressiveness of the rod seal, rod surface finish and rod speed. If the rod seal chosen is less aggressive than the wiper, the wiper can wipe away the oil film during retract, resulting in system leakage.

Examples of poor wiper/rod seal combinations include using a soft rubber u-cup with an aggressive urethane wiper, or a rod seal with net molded lips paired with a knife trimmed wiper. In both cases a less aggressive rod seal is improperly paired with a more aggressive wiper.















Wiper Product Offering

Profiles

Table 8-1: Product Profiles

Series	Description	Application (Duty)				Page
		Light	Medium	Heavy	Pneu	
YD 	Premium Snap-In Wiper with O.D. Exclusion Technology					8-5
SHD 	Industrial Snap-In Wiper					8-9
SH959 	AN-Style Snap-In Wiper					8-13
AH 	Premium Double-Lip Canned Wiper					8-15

Preferred Wiper profile

Series	Description	Application (Duty)				Page
		Light	Medium	Heavy	Pneu	
J 	Performance Canned Wiper					8-17
AY 	Premium Double-Lip Wiper					8-19
H / 8600 	Performance Double-Lip Wiper					8-22
AD 	PTFE Wiper Seal					8-24

Wiper Decision Tree

Catalog EPS 5370/USA

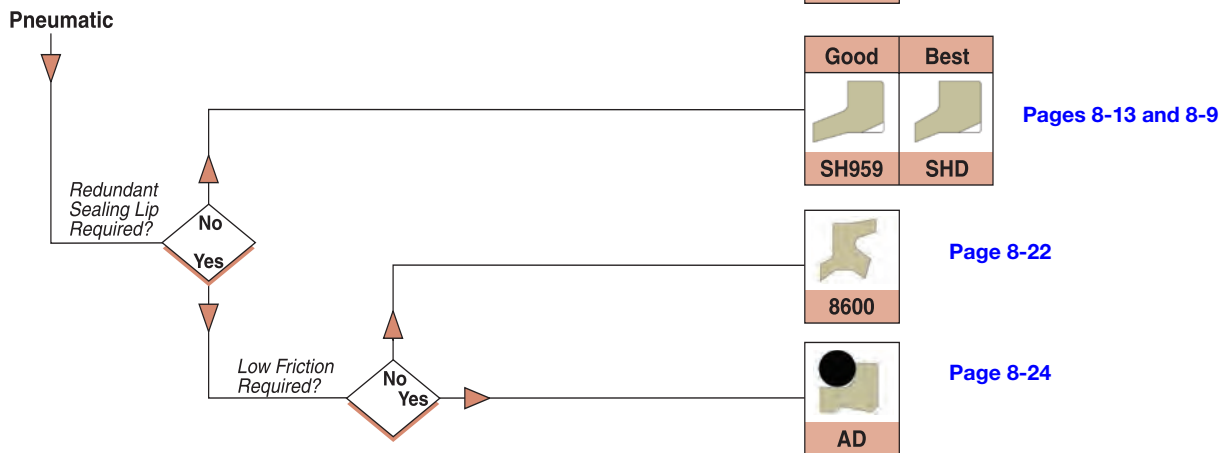
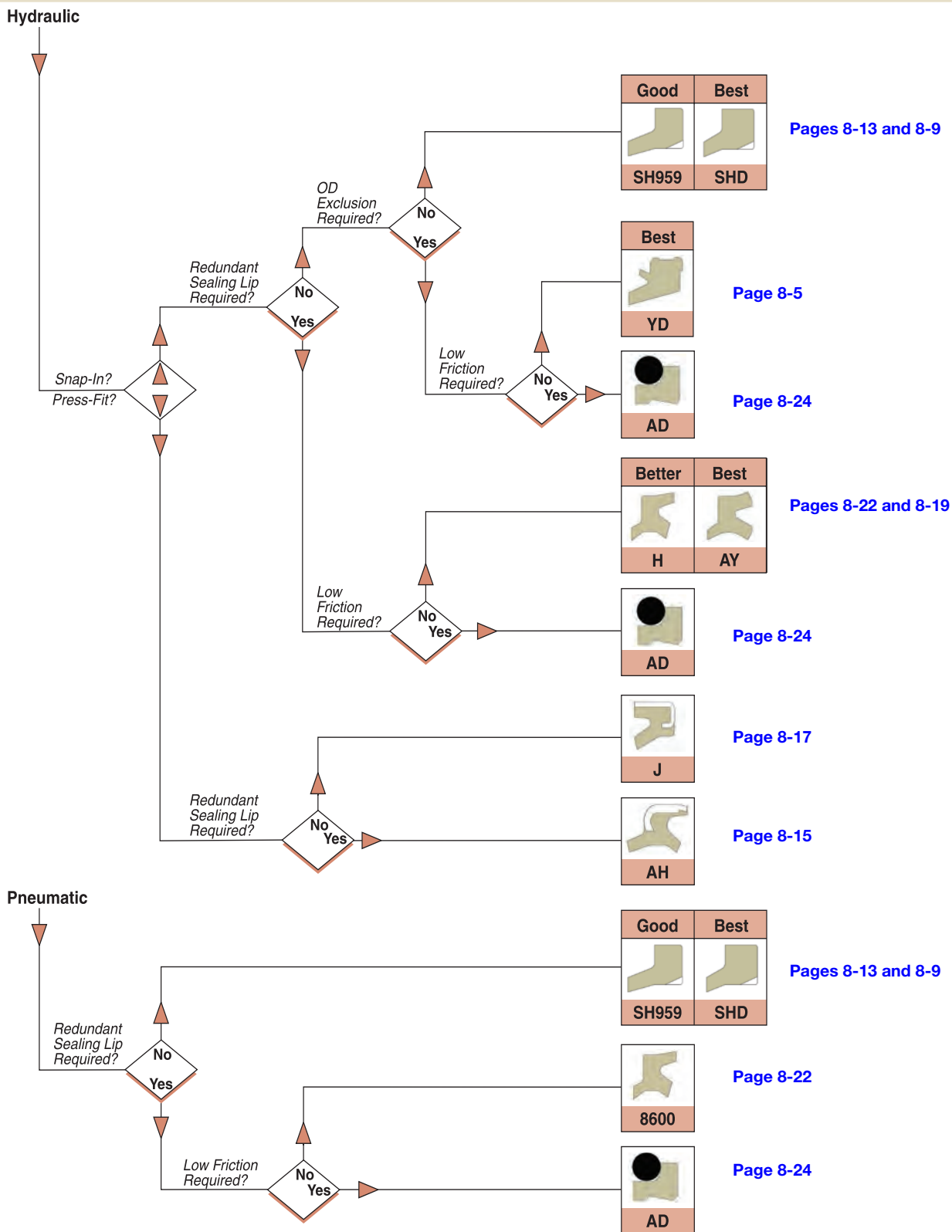

Note: Decision Tree is for profile geometry only. Please consult [pages 8-5 through 8-40](#) for proper material selection.

06/01/2014

Wiper YD Profile

◆ Preferred Profile

Catalog EPS 5370/USA



YD Profile, Premium Snap-in Wiper with O.D. Exclusion Technology

The YD profile wiper is the premier design among high performance, snap-in excluders. Featuring a secondary O.D. lip which seals against the shoulder region of the gland, the YD profile wiper prevents water and other contaminants from entering around the static side of the wiper. For ultimate performance, the YD profile also incorporates an aggressive, knife-trimmed wiping lip to ensure maximum exclusion along the rod. A true zero-radius lip provides the most effective wiping action available.

Technical Data

Standard Materials	Temperature Range	Pressure Range†	Surface Speed
P4300A90	-65°F to +275°F (-54°C to +135°C)	5,000 psi (344 bar)	< 1.6 ft/s (0.5 m/s)
P4301A90	-65°F to +275°F (-54°C to +135°C)	5000 psi (344 bar)	< 1.6 ft/s (0.5 m/s)

Alternate Materials: For applications that may require an alternate material, please go to www.parker.com/eps/FluidPower to check current tooling and part number availability, or contact your local Parker representative.



YD Cross-Section

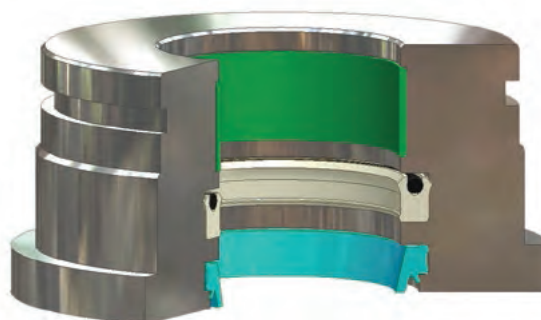

YD installed in Rod Gland



Part Number Nomenclature – YD Profile

Table 8-2. YD Profile

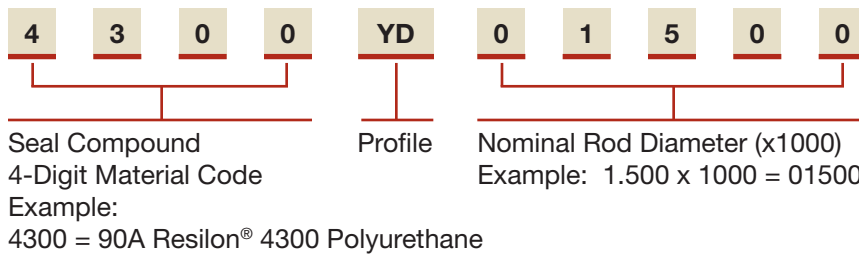

Gland Dimensions – YD Profile

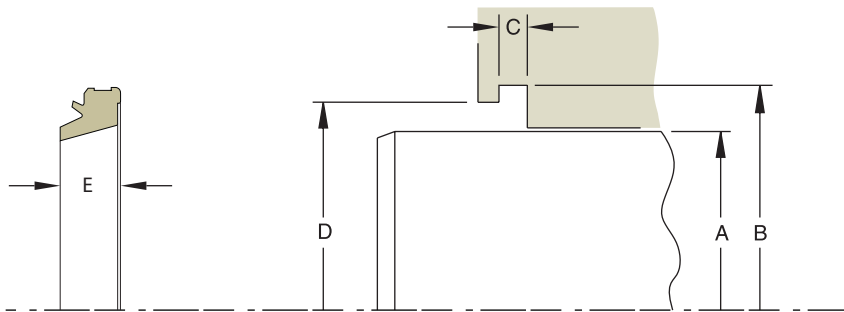

Please refer to Engineering [Section 2, page 2-8](#) for surface finish and additional hardware considerations.

Table 8-3. YD Profile – Wiper Gland Calculation

A Rod Diameter		B Groove Diameter		C Groove Width	D Shoulder Diameter		E Max Wiper Axial Width
Range	Tol.	Calculation	Tol.	+0.004/ -.000	Calculation	Tol.	
0.250 – 0.687	+0.000/-0.003	Dia. A + .247	+0.006/-0.000	0.124	Dia. A + .160	+0.005/-0.000	0.215
0.750 – 1.875	+0.000/-0.003	Dia. A + .372	+0.006/-0.000	0.187	Dia. A + .245	+0.005/-0.000	0.315
2.000 – 4.375	+0.000/-0.003	Dia. A + .497	+0.006/-0.000	0.249	Dia. A + .327	+0.005/-0.000	0.415
4.500 – 6.000	+0.000/-0.003	Dia. A + .747	+0.006/-0.000	0.374	Dia. A + .493	+0.005/-0.000	0.620
6.500 – 9.000	+0.000/-0.004	Dia. A + .747	+0.006/-0.000	0.374	Dia. A + .493	+0.005/-0.000	0.620
9.000 – 10.000	+0.000/-0.005	Dia. A + .997	+0.006/-0.000	0.499	Dia. A + .659	+0.005/-0.000	0.820

For custom groove calculations, see [Appendix C](#).

Above table reflects recommended cross-sections for rod diameters shown. Alternate cross-sections and additional sizes may be considered. Consult www.parker.com/eps/FluidPower for hardware specifications, additional cross-sections and sizes, and part number availability. Contact your Parker representative for assistance.

Gland Dimensions — YD Profile
Table 8-4. YD Profile — Wiper Gland Dimensions, ♦Parker Standard Sizes

Hardware Dimensions						Part Number
A Rod Diameter	B Groove Diameter	C Groove Width	D Shoulder Diameter	E Max Wiper Axial Width		
Tolerance	+ .006/- .000	+ .004/- .000	+ .005/- .000			
0.250	+ .000/- .002	0.497	0.124	0.410	0.215	4300YD00250
0.312	+ .000/- .002	0.560	0.124	0.475	0.215	4300YD00312
0.375	+ .000/- .002	0.622	0.124	0.535	0.215	4300YD00375
0.437	+ .000/- .002	0.685	0.124	0.600	0.215	4300YD00437
0.500	+ .000/- .002	0.747	0.124	0.660	0.215	4300YD00500
0.625	+ .000/- .002	0.872	0.124	0.785	0.215	4300YD00625
0.750	+ .000/- .002	1.122	0.187	0.995	0.315	4300YD00750
0.875	+ .000/- .002	1.247	0.187	1.120	0.315	4300YD00875
1.000	+ .000/- .002	1.372	0.187	1.245	0.315	4300YD01000
1.125	+ .000/- .002	1.497	0.187	1.370	0.315	4300YD01125
1.250	+ .000/- .002	1.622	0.187	1.495	0.315	4300YD01250
1.375	+ .000/- .002	1.747	0.187	1.620	0.315	4300YD01375
1.500	+ .000/- .002	1.872	0.187	1.745	0.315	4300YD01500
1.625	+ .000/- .002	1.997	0.187	1.870	0.315	4300YD01625
1.750	+ .000/- .002	2.122	0.187	1.995	0.315	4300YD01750
1.875	+ .000/- .002	2.247	0.187	2.120	0.315	4300YD01875
2.000	+ .000/- .002	2.497	0.249	2.327	0.415	4300YD02000
2.125	+ .000/- .003	2.622	0.249	2.452	0.415	4300YD02125
2.250	+ .000/- .003	2.747	0.249	2.577	0.415	4300YD02250
2.375	+ .000/- .003	2.872	0.249	2.702	0.415	4300YD02375
2.500	+ .000/- .003	2.997	0.249	2.827	0.415	4300YD02500
2.625	+ .000/- .003	3.122	0.249	2.952	0.415	4300YD02625
2.750	+ .000/- .003	3.247	0.249	3.077	0.415	4300YD02750
3.000	+ .000/- .003	3.497	0.249	3.327	0.415	4300YD03000
3.250	+ .000/- .003	3.747	0.249	3.577	0.415	4300YD03250
3.500	+ .000/- .003	3.997	0.249	3.827	0.415	4300YD03500
3.750	+ .000/- .003	4.247	0.249	4.077	0.415	4300YD03750
4.000	+ .000/- .003	4.497	0.249	4.327	0.415	4300YD04000
4.250	+ .000/- .003	4.747	0.249	4.577	0.415	4300YD04250
4.500	+ .000/- .003	5.247	0.374	4.993	0.620	4300YD04500
4.750	+ .000/- .003	5.497	0.374	5.243	0.620	4300YD04750
5.000	+ .000/- .003	5.747	0.374	5.493	0.620	4300YD05000
5.500	+ .000/- .003	6.247	0.374	5.993	0.620	4300YD05500
6.000	+ .000/- .003	6.747	0.374	6.493	0.620	4300YD06000

For custom groove calculations, see [Appendix C](#).

Above table reflects recommended cross-sections for rod diameters shown. Alternate cross-sections and additional sizes may be considered. Consult www.parker.com/eps/FluidPower for hardware specifications, additional cross-sections and sizes, and part number availability. Contact your Parker representative for assistance.

Continued on the following page

Gland Dimensions – YD Profile

Table 8-4. YD Profile – Wiper Gland Dimensions, ♦Parker Standard Sizes (cont'd)

Hardware Dimensions						Part Number
A Rod Diameter	B Groove Diameter	C Groove Width	D Shoulder Diameter	E Max Wiper Axial Width	Tolerance	
		+0.006/-0.000	+0.004/-0.000	+0.005/-0.000		
6.500	+0.000/-0.004	7.247	0.374	6.993	0.620	4300YD06500
6.750	+0.000/-0.004	7.497	0.374	7.243	0.620	4300YD06750
7.000	+0.000/-0.004	7.747	0.374	7.493	0.620	4300YD07000
7.500	+0.000/-0.004	8.247	0.374	7.993	0.620	4300YD07500
8.000	+0.000/-0.004	8.747	0.374	8.493	0.620	4300YD08000
8.500	+0.000/-0.004	9.247	0.374	8.993	0.620	4300YD08500
9.000	+0.000/-0.005	9.747	0.374	9.493	0.620	4300YD09000
10.000	+0.000/-0.005	10.997	0.499	10.659	0.820	4300YD10000
10.750	+0.000/-0.005	11.747	0.499	11.409	0.820	4300YD10625
11.000	+0.000/-0.005	11.997	0.499	11.659	0.820	4300YD11000
12.000	+0.000/-0.005	12.997	0.499	12.659	0.820	4300YD12000
12.500	+0.000/-0.005	13.497	0.499	13.159	0.820	4300YD12500
14.000	+0.000/-0.005	14.997	0.499	14.659	0.820	4300YD14000
14.750	+0.000/-0.005	15.747	0.499	15.409	0.820	4300YD14750
15.000	+0.000/-0.005	15.997	0.499	15.659	0.820	4300YD15000
16.000	+0.000/-0.005	16.997	0.499	16.659	0.820	4300YD16000
20.000	+0.000/-0.005	20.997	0.499	20.659	0.820	4300YD20000
30.000	+0.000/-0.005	30.997	0.499	30.659	0.820	4300YD30000

For custom groove calculations, see [Appendix C](#).

Above table reflects recommended cross-sections for rod diameters shown. Alternate cross-sections and additional sizes may be considered. Consult www.parker.com/eps/FluidPower for hardware specifications, additional cross-sections and sizes, and part number availability. Contact your Parker representative for assistance.

Wiper SHD Profile

◆ Preferred Profile

Catalog EPS 5370/USA

SHD Profile, Industrial Snap-In Wiper

Parker SHD profile wipers are an outstanding choice for light and medium duty hydraulic and pneumatic applications. The slotted heel design prevents pressure traps from forming between the rod seal and wiper. Broad tooling availability, up to 30", makes the SHD a good choice for large rod diameters. The snap-in design is oversized for a snug fit and excellent stability. This makes the SHD a great all-round wiper in an economical package.



Technical Data

Standard Materials	Temperature Range	Surface Speed
P4615A90	-65°F to +200°F (-54°C to +93°C)	<1.6 f/s (0.5 m/s)
P5065A88	-70°F to +200°F (-57°C to +93°C)	<1.6 f/s (0.5 m/s)

Alternate Materials: For applications that may require an alternate material, please go to www.parker.com/eps/FluidPower to check current tooling and part number availability, or contact your local Parker representative.



SHD Cross-Section

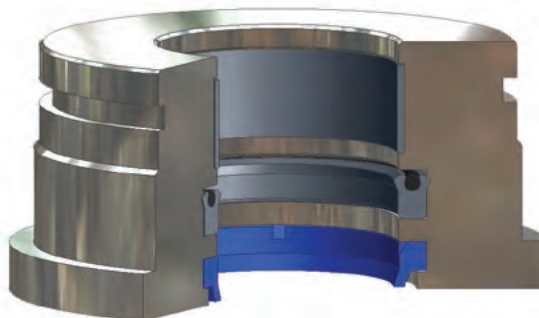

SHD installed in Rod Gland



Part Number Nomenclature – SHD Profile

Table 8-5. SHD Profile

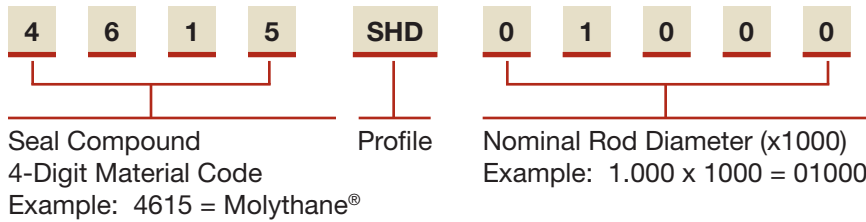

Gland Dimensions – SHD Profile

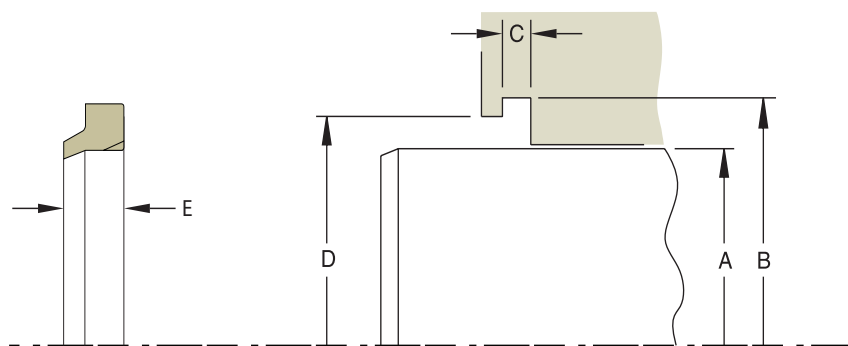

Please refer to Engineering [Section 2](#), [page 2-8](#) for surface finish and additional hardware considerations.

Table 8-6. SHD Profile – Wiper Gland Calculation

A Rod Diameter		B Groove Diameter		C Groove Width	D Shoulder Diameter		E Max Wiper Axial Width
Range	Tol.	Calculation	Tol.	+0.004/ -.000	Calculation	Tol.	
0.250 – 0.687	+0.000/-0.003	Dia. A + .247	+0.006/-0.000	0.124	Dia. A + .160	+0.005/-0.000	0.215
0.750 – 1.875	+0.000/-0.003	Dia. A + .372	+0.006/-0.000	0.187	Dia. A + .245	+0.005/-0.000	0.315
2.000 – 4.375	+0.000/-0.003	Dia. A + .497	+0.006/-0.000	0.249	Dia. A + .327	+0.005/-0.000	0.415
4.500 – 6.000	+0.000/-0.003	Dia. A + .747	+0.006/-0.000	0.374	Dia. A + .493	+0.005/-0.000	0.620
6.500 – 9.000	+0.000/-0.004	Dia. A + .747	+0.006/-0.000	0.374	Dia. A + .493	+0.005/-0.000	0.620
9.000 – 10.000	+0.000/-0.005	Dia. A + .997	+0.006/-0.000	0.499	Dia. A + .659	+0.005/-0.000	0.820

For custom groove calculations, see [Appendix C](#).

Above table reflects recommended cross-sections for rod diameters shown. Alternate cross-sections and additional sizes may be considered. Consult www.parker.com/eps/FluidPower for hardware specifications, additional cross-sections and sizes, and part number availability. Contact your Parker representative for assistance.

Gland Dimensions — SHD Profile

Table 8-7. SHD Profile — Wiper Gland Dimensions, ♦Parker Standard Sizes

A Rod Diameter		Hardware Dimensions				E Max Wiper Axial Width	Part Number (Replace xxxx with Material Code 4615 or 5065)
Tolerance	B Groove Diameter	C Groove Width	D Shoulder Diameter				
0.250	+0.006/-0.000	+0.004/-0.000	+0.005/-0.000		0.215	xxxxSHD00250	
0.312	0.497	0.124	0.410		0.215	xxxxSHD00250	
0.312	0.560	0.124	0.475		0.215	xxxxSHD00312	
0.375	0.622	0.124	0.535		0.215	xxxxSHD00375	
0.437	0.685	0.124	0.600		0.215	xxxxSHD00437	
0.500	0.747	0.124	0.660		0.215	xxxxSHD00500	
0.625	0.872	0.124	0.785		0.215	xxxxSHD00625	
0.750	1.122	0.187	0.995		0.315	xxxxSHD00750	
0.875	1.247	0.187	1.120		0.315	xxxxSHD00875	
1.000	1.372	0.187	1.245		0.315	xxxxSHD01000	
1.125	1.497	0.187	1.370		0.315	xxxxSHD01125	
1.250	1.622	0.187	1.495		0.315	xxxxSHD01250	
1.375	1.747	0.187	1.620		0.315	xxxxSHD01375	
1.500	1.872	0.187	1.745		0.315	xxxxSHD01500	
1.625	1.997	0.187	1.870		0.315	xxxxSHD01625	
1.750	2.122	0.187	1.995		0.315	xxxxSHD01750	
1.875	2.247	0.187	2.120		0.315	xxxxSHD01875	
2.000	2.497	0.249	2.327		0.415	xxxxSHD02000	
2.125	2.622	0.249	2.452		0.415	xxxxSHD02125	
2.250	2.747	0.249	2.577		0.415	xxxxSHD02250	
2.375	2.872	0.249	2.702		0.415	xxxxSHD02375	
2.500	2.997	0.249	2.827		0.415	xxxxSHD02500	
2.625	3.122	0.249	2.952		0.415	xxxxSHD02625	
2.750	3.247	0.249	3.077		0.415	xxxxSHD02750	
3.000	3.497	0.249	3.327		0.415	xxxxSHD03000	
3.250	3.747	0.249	3.577		0.415	xxxxSHD03250	
3.500	3.997	0.249	3.827		0.415	xxxxSHD03500	
3.750	4.247	0.249	4.077		0.415	xxxxSHD03750	
4.000	4.497	0.249	4.327		0.415	xxxxSHD04000	
4.250	4.747	0.249	4.577		0.415	xxxxSHD04250	
4.500	5.247	0.374	4.993		0.620	xxxxSHD04500	
4.750	5.497	0.374	5.243		0.620	xxxxSHD04750	
5.000	5.747	0.374	5.493		0.620	xxxxSHD05000	
5.500	6.247	0.374	5.993		0.620	xxxxSHD05500	
6.000	6.747	0.374	6.493		0.620	xxxxSHD06000	

For custom groove calculations, see [Appendix C](#).

Above table reflects recommended cross-sections for rod diameters shown. Alternate cross-sections and additional sizes may be considered. Consult www.parker.com/eps/FluidPower for hardware specifications, additional cross-sections and sizes, and part number availability. Contact your Parker representative for assistance.

Continued on the following page

06/01/2014

Gland Dimensions – SHD Profile**Table 8-7. SHD Profile – Wiper Gland Dimensions, ♦Parker Standard Sizes (cont'd)**

Hardware Dimensions						Part Number (Replace xxxx with Material Code 4615 or 5065)
A Rod Diameter	B Groove Diameter	C Groove Width	D Shoulder Diameter	E Max Wiper Axial Width	Tolerance	
		+.006/-.000	+.004/-.000	+.005/-.000		
6.500		7.247	0.374	6.993	+.000/-.004	xxxxSHD06500
6.750		7.497	0.374	7.243	+.000/-.004	xxxxSHD06750
7.000		7.747	0.374	7.493	+.000/-.004	xxxxSHD07000
7.500		8.247	0.374	7.993	+.000/-.004	xxxxSHD07500
8.000		8.747	0.374	8.493	+.000/-.004	xxxxSHD08000
8.500		9.247	0.374	8.993	+.000/-.004	xxxxSHD08500
9.000		9.747	0.374	9.493	+.000/-.005	xxxxSHD09000
10.000		10.997	0.499	10.659	+.000/-.005	xxxxSHD10000
10.625		11.622	0.499	11.409	+.000/-.005	xxxxSHD10625
11.000		11.997	0.499	11.659	+.000/-.005	xxxxSHD11000
12.000		12.997	0.499	12.659	+.000/-.005	xxxxSHD12000
12.500		13.497	0.499	13.159	+.000/-.005	xxxxSHD12500
14.000		14.997	0.499	14.659	+.000/-.005	xxxxSHD14000
14.750		15.747	0.499	15.409	+.000/-.005	xxxxSHD14750
15.000		15.997	0.499	15.659	+.000/-.005	xxxxSHD15000
16.000		16.997	0.499	16.659	+.000/-.005	xxxxSHD16000
20.000		20.997	0.499	20.659	+.000/-.005	xxxxSHD20000
30.000		30.997	0.499	30.659	+.000/-.005	xxxxSHD30000

For custom groove calculations, see [Appendix C](#).

Above table reflects recommended cross-sections for rod diameters shown. Alternate cross-sections and additional sizes may be considered. Consult www.parker.com/eps/FluidPower for hardware specifications, additional cross-sections and sizes, and part number availability. Contact your Parker representative for assistance.

Wiper SH959 Profile

Catalog EPS 5370/USA

SH959 Profile, AN-Style Snap-In Wiper

Parker SH959 profile wipers are AN style excluders designed to ensure proper fit with all MS-28776 (MS-33675) dash size grooves. The slotted heel design prevents pressure traps from forming between the rod seal and wiper. This profile of wiper requires very little radial or axial space. This is why they are ideal in light to medium duty hydraulic and pneumatic applications where such space constraints are present.



SH959 Cross-Section

Technical Data

Standard Materials	Temperature Range	Surface Speed
P4615A90	-65°F to +200°F (-54°C to +93°C)	<1.6 ft/s (0.5 m/s)
P5065A88	-70°F to +200°F (-57°C to +93°C)	<1.6 ft/s (0.5 m/s)
N4263A90	-20°F to +275°F (-29°C to +135°C)	<3.3 ft/s (1.0 m/s)
V4208A90	-5°F to +400°F (-21°C to +204°C)	<3.3 ft/s (1.0 m/s)
E4207A90	-65°F to +300°F (-54°C to +149°C)	<3.3 ft/s (1.0 m/s)

Alternate Materials: For applications that may require an alternate material, please go to www.parker.com/eps/FluidPower to check current tooling and part number availability, or contact your local Parker representative.

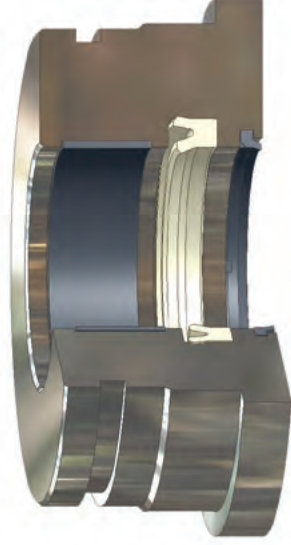

SH959 installed in Rod Gland

Part Number Nomenclature – SH959 Profile

Table 8-8. SH959 Profile

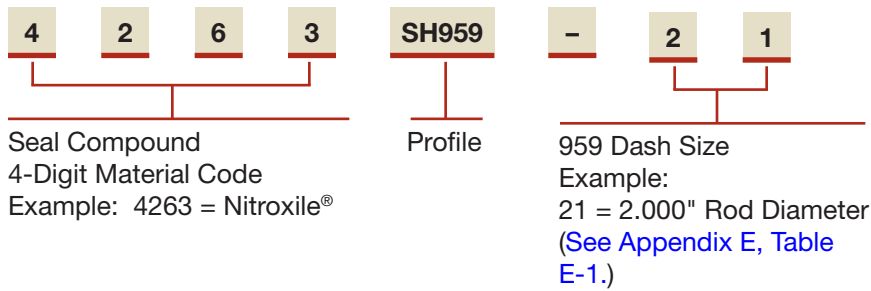

Gland Dimensions – SH959 Profile – See Appendix E

SH959 Profile wipers are designed to fit MS-28776 (MS-33675) grooves. Gland dimensions are provided in Appendix E.

Wiper AH Profile

Catalog EPS 5370/USA



AH Profile, Premium Double-Lip Canned Wiper

Parker's AH profile wiper is the ultimate metal-clad excluder for heavy duty hydraulic applications. Press-fit installation prevents O.D. contamination while the additional sealing lip works in conjunction with Parker rod seals to provide redundant sealing for leakage reduction. An aggressive wiping lip, facing the environment, ensures the utmost performance in contaminant exclusion along the rod.

IMPORTANT: When using the AH wiper in conjunction with other rod seals, it is important to select a rod seal profile that enables pressure relief of fluid into the system, otherwise a pressure trap may form between the wiper and rod seal. Suggested rod profiles are BT, BS, and B3 u-cups.

Technical Data

Standard Materials
P4300A90

Temperature Range
-65°F to +275°F
(-54°C to +135°C)

Surface Speed
<1.6 ft/s
(0.5 m/s)

Alternate Materials: For applications that may require an alternate material, please go to www.parker.com/eps/FluidPower to check current tooling and part number availability, or contact your local Parker representative.



AH Cross-Section

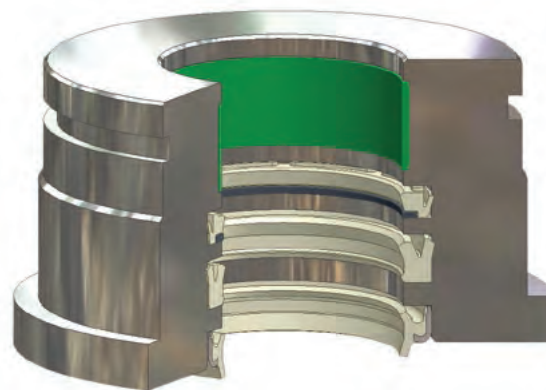

AH installed in Rod Gland

Part Number Nomenclature – AH Profile

Table 8-9. AH Profile

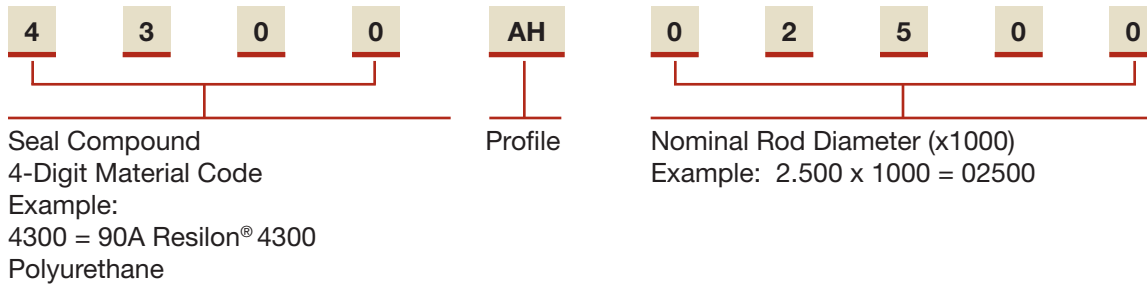

Gland Dimensions – AH Profile

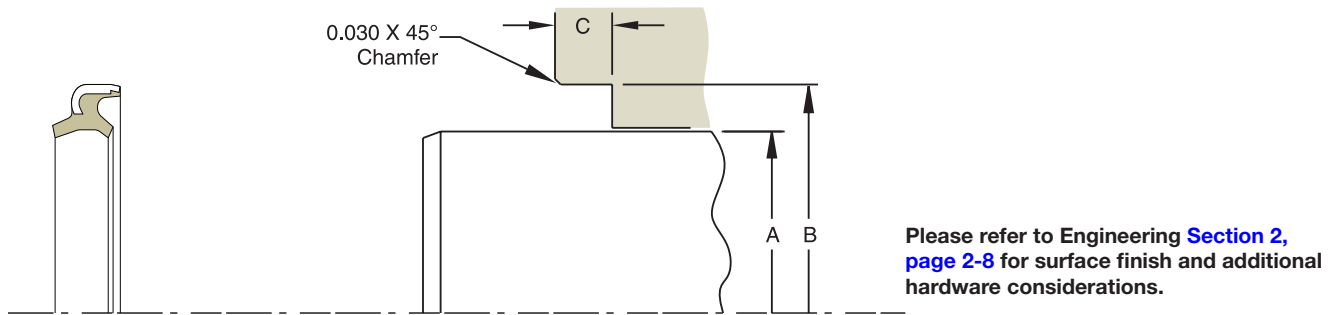

Gland Dimensions – AH Profile

Table 8-10. AH Profile – Wiper Gland Calculation

A Rod Diameter		B Groove Diameter	C Groove Width	
Range	Tol.	+ .001/- .001		Tol.
0.500 – 0.624	+ .000/- .002	Dia. A + .500	0.250	+ .015/- .000
0.625 – 2.000	+ .000/- .002	Dia. A + .500	0.312	+ .015/- .000
2.125 – 3.000	+ .000/- .003	Dia. A + .500	0.312	+ .015/- .000
3.250 – 5.250	+ .000/- .003	Dia. A + .625	0.312	+ .015/- .000
5.500 – 8.000	+ .000/- .004	Dia. A + .625	0.375	+ .015/- .015

Above table reflects recommended cross-sections for rod diameters shown. Alternate cross-sections and additional sizes may be considered. Consult www.parker.com/eps/FluidPower for hardware specifications, additional cross-sections and sizes, and part number availability. Contact your Parker representative for assistance.

Wiper J Profile

◆ Preferred Profile

Catalog EPS 5370/USA



J Profile, Performance Canned Wiper

The press-fit installation of Parker's J profile wiper guards against O.D. contamination and results in simple counter-bore groove machining. The wiping lip on the J profile wiper is very aggressive, eliminating the ingress of dust, mud and moisture from harsh work areas. J profile wipers are ideal for medium and heavy duty hydraulic cylinders in the most demanding applications.

Technical Data

Standard Materials	Temperature Range	Surface Speed
P4700A90	-65° to +200°F (-54°C to +93°C)	<1.6 ft/s (0.5 m/s)
Additional Materials		
P4300A90	-65°F to +275°F (-54°C to +135°C)	<1.6 ft/s (0.5 m/s)
P4615A90	-65°F to +200°F (-54°C to +93°C)	<1.6 ft/s (0.5 m/s)

Alternate Materials: For applications that may require an alternate material, please go to www.parker.com/eps/FluidPower to check current tooling and part number availability, or contact your local Parker representative.



J Cross-Section

Part Number Nomenclature — J Profile

Table 8-11. J Profile

4	7	0	0	J	0	3	0	0	0
└──────────┘				└──┘	└──────────┘				
Seal Compound 4-Digit Material Code Example: 4700 = Polyurethane				Profile	Nominal Rod Diameter (x1000) Example: 3.00 x 1000 = 03000 (5 digits. Add leading zeros if needed)				

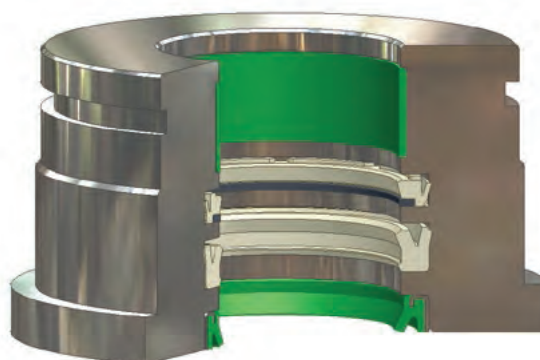

J installed in Rod Gland

06/01/2014

Gland Dimensions — J Profile

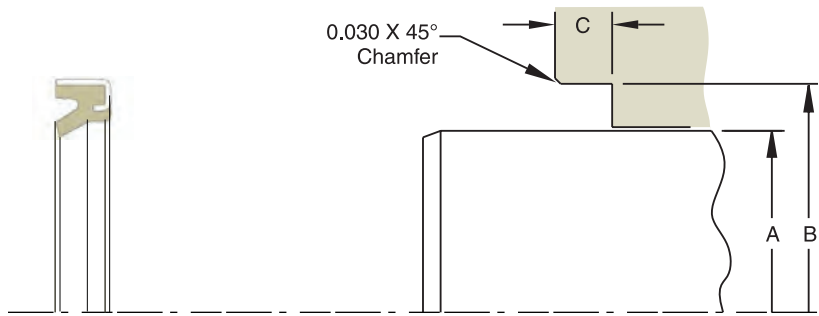

Please refer to Engineering [Section 2](#), [page 2-8](#) for surface finish and additional hardware considerations.

Table 8-12. J Profile — Wiper Gland Calculation

A Rod Diameter		B Groove Diameter	C Groove Width	
Range	Tol.	+0.001/-0.001		Tol.
0.500 – 0.624	+0.000/-0.002	Dia. A + .500	0.250	+0.015/-0.000
0.625 – 2.000	+0.000/-0.002	Dia. A + .500	0.312	+0.015/-0.000
2.125- 3.000	+0.000/-0.003	Dia. A + .500	0.312	+0.015/-0.000
3.250 – 5.250	+0.000/-0.003	Dia. A + .625	0.312	+0.015/-0.000
5.500 – 8.000	+0.000/-0.004	Dia. A + .625	0.375	+0.015/-0.015

Above table reflects recommended cross-sections for rod diameters shown. Alternate cross-sections and additional sizes may be considered. Consult www.parker.com/eps/FluidPower for hardware specifications, additional cross-sections and sizes, and part number availability. Contact your Parker representative for assistance.

Gland Dimensions — J Profile

Table 8-13. J Profile — Wiper Gland Dimensions, ♦Parker Standard Sizes

Hardware Dimensions				Part Number
A Rod Dia.	B Groove Dia.	C Groove Width	Tol.	
0.750	+0.000/-0.002	1.250	+0.001/-0.001	4700J00750
0.875	+0.000/-0.002	1.375	+0.015/-0.000	4700J00875
1.000	+0.000/-0.002	1.500	+0.015/-0.000	4700J01000
1.125	+0.000/-0.002	1.625	+0.015/-0.000	4700J01125
1.250	+0.000/-0.002	1.750	+0.015/-0.000	4700J01250
1.375	+0.000/-0.002	1.875	+0.015/-0.000	4700J01375
1.500	+0.000/-0.002	2.000	+0.015/-0.000	4700J01500
1.750	+0.000/-0.002	2.250	+0.015/-0.000	4700J01750
2.000	+0.000/-0.002	2.500	+0.015/-0.000	4700J02000
2.125	+0.000/-0.003	2.625	+0.015/-0.000	4700J02125
2.250	+0.000/-0.003	2.750	+0.015/-0.000	4700J02250
2.375	+0.000/-0.003	2.875	+0.015/-0.000	4700J02375
2.500	+0.000/-0.003	3.000	+0.015/-0.000	4700J02500
2.625	+0.000/-0.003	3.125	+0.015/-0.000	4700J02625
2.750	+0.000/-0.003	3.250	+0.015/-0.000	4700J02750

Hardware Dimensions				Part Number
A Rod Dia.	B Groove Dia.	C Groove Width	Tol.	
3.000	+0.000/-0.003	3.500	+0.015/-0.000	4700J03000
3.250	+0.000/-0.003	3.875	+0.015/-0.000	4700J03250
3.500	+0.000/-0.003	4.125	+0.015/-0.000	4700J03500
3.750	+0.000/-0.003	4.375	+0.015/-0.000	4700J03750
4.000	+0.000/-0.003	4.625	+0.015/-0.000	4700J04000
4.250	+0.000/-0.003	4.875	+0.015/-0.000	4700J04250
4.500	+0.000/-0.003	5.125	+0.015/-0.000	4700J04500
5.000	+0.000/-0.003	5.625	+0.015/-0.000	4700J05000
5.500	+0.000/-0.003	6.125	+0.015/-0.000	4700J05500

Above table reflects recommended cross-sections for rod diameters shown. Alternate cross-sections and additional sizes may be considered. Consult www.parker.com/eps/FluidPower for hardware specifications, additional cross-sections and sizes, and part number availability. Contact your Parker representative for assistance.

Wiper AY Profile

◆ Preferred Profile

Catalog EPS 5370/USA



AY Profile, Premium Double-Lip Wiper

The AY profile can be used as a heavy to light duty wiper. When used in high pressure applications with the proper Parker rod seals, the AY profile complements the sealing system by providing an additional beveled sealing lip, yielding excellent film-breaking and the driest rod sealing available. These dual acting features also enable it to be used by itself in low pressure applications as both the rod seal and the wiper. Knife-trimmed sealing lips ensure the best possible film breaking.

IMPORTANT: When using the AY wiper in conjunction with other rod seals, it is important to select a rod seal profile that enables pressure relief of fluid into the system, otherwise a pressure trap may form between the wiper and rod seal. Suggested rod profiles are **BT**, **BS**, and **B3** u-cups.



AY Cross-Section

Technical Data

Standard Materials	Temperature Range	Surface Speed
P4300A90	-65°F to +275°F (-54°C to +135°C)	<1.6 ft/s (0.5 m/s)
Additional Materials		
P4301A90	-35°F to +225°F (-37°C to +107°C)	<1.6 ft/s (0.5 m/s)
P4700A90	-65° to +200°F (-54°C to +93°C)	<1.6 ft/s (0.5 m/s)

Alternate Materials: For applications that may require an alternate material, please contact your local Parker representative.

Part Number Nomenclature – AY Profile

Table 8-14. AY Profile

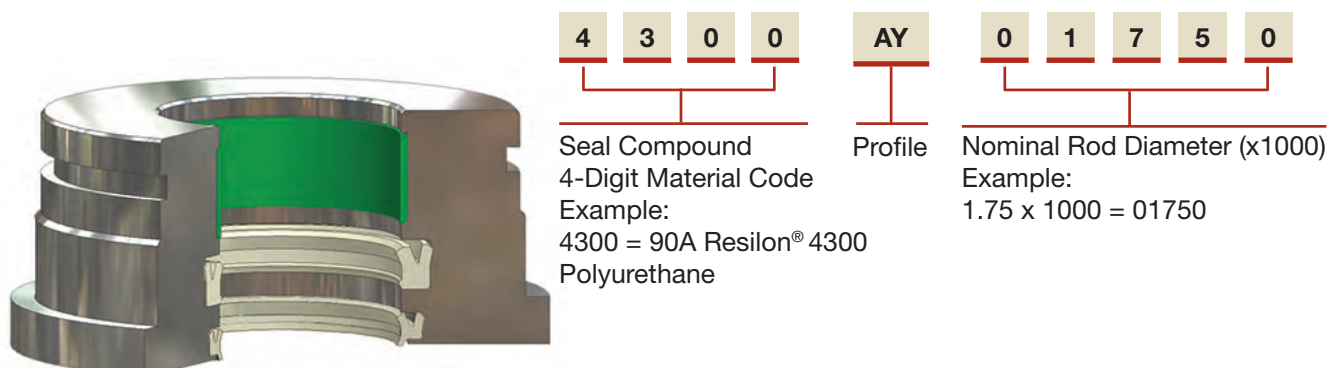

AY installed in Rod Gland

06/01/2014

Gland Dimensions – AY Profile

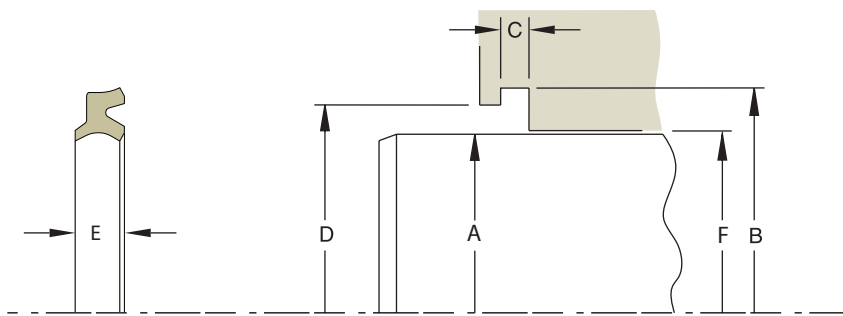

Please refer to Engineering [Section 2, page 2-8](#) for surface finish and additional hardware considerations.

Table 8-15. AY Profile – Wiper Gland Calculation

A Rod Diameter		B Groove Diameter	C Groove Width	D Shoulder Diameter	E Max Wiper Axial Width	F Throat Diameter*
Range	Tol.	+0.003/-0.000	+0.005/-0.000	+0.003/-0.000		+0.003/-0.000
0.250 – 0.750	+0.000/-0.002	Dia. A + .302	0.203	Dia. A + .120	0.245	Dia. A + .001
0.812 – 2.125	+0.000/-0.003	Dia. A + .365	0.218	Dia. A + .135	0.275	Dia. A + .001
2.187 – 6.000	+0.000/-0.003	Dia. A + .495	0.281	Dia. A + .135	0.351	Dia. A + .001
6.250 – 8.500	+0.000/-0.004	Dia. A + .495	0.281	Dia. A + .135	0.351	Dia. A + .001
8.750 – 10.000	+0.000/-0.005	Dia. A + .495	0.281	Dia. A + .135	0.351	Dia. A + .001

* If used with wear rings, refer to wear ring throat diameter, see [Section 9](#). For custom groove calculations, see [Appendix C](#).

Above table reflects recommended cross-sections for rod diameters shown. Alternate cross-sections and additional sizes may be considered. Consult www.parker.com/eps/FluidPower for hardware specifications, additional cross-sections and sizes, and part number availability. Contact your Parker representative for assistance.

8

Gland Dimensions – AY Profile

Table 8-16. AY Profile – Wiper Gland Dimensions, Parker Standard Sizes

A Rod Diameter	B Groove Diameter	C Groove Width	D Shoulder Diameter	E Max. Wiper Axial Width	F Throat Diameter*	Part Number				
Tol.	Tol.	+0.005/-0.000	Tol.		Tol.					
0.250	+0.000/-0.002	0.552	+0.002/-0.000	0.203	0.370	+0.002/-0.000	0.245	0.251	+0.002/-0.000	4300AY00250
0.312	+0.000/-0.002	0.615	+0.002/-0.000	0.203	0.432	+0.002/-0.000	0.245	0.313	+0.002/-0.000	4300AY00312
0.375	+0.000/-0.002	0.677	+0.002/-0.000	0.203	0.495	+0.002/-0.000	0.245	0.376	+0.002/-0.000	4300AY00375
0.437	+0.000/-0.002	0.740	+0.002/-0.000	0.203	0.557	+0.002/-0.000	0.245	0.438	+0.002/-0.000	4300AY00437
0.500	+0.000/-0.002	0.802	+0.002/-0.000	0.203	0.620	+0.002/-0.000	0.245	0.501	+0.002/-0.000	4300AY00500
0.562	+0.000/-0.002	0.865	+0.002/-0.000	0.203	0.682	+0.002/-0.000	0.245	0.563	+0.002/-0.000	4300AY00562
0.750	+0.000/-0.002	1.052	+0.002/-0.000	0.203	0.870	+0.002/-0.000	0.245	0.751	+0.002/-0.000	4300AY00750
0.812	+0.000/-0.002	1.177	+0.002/-0.000	0.218	0.947	+0.002/-0.000	0.275	0.813	+0.002/-0.000	4300AY00812
0.875	+0.000/-0.002	1.240	+0.002/-0.000	0.218	1.010	+0.002/-0.000	0.275	0.876	+0.002/-0.000	4300AY00875

* If used with wear rings, refer to wear ring throat diameter, see [Section 9](#). For custom groove calculations, see [Appendix C](#).

Above table reflects recommended cross-sections for rod diameters shown. Alternate cross-sections and additional sizes may be considered. Consult www.parker.com/eps/FluidPower for hardware specifications, additional cross-sections and sizes, and part number availability. Contact your Parker representative for assistance.

Continued on the following page

06/01/2014

Gland Dimensions — AY Profile

Table 8-16. AY Profile — Wiper Gland Dimensions, ♦Parker Standard Sizes (cont'd)

A Rod Diameter	B Groove Diameter	C Groove Width	D Shoulder Diameter	E Max. Wiper Axial Width	F Throat Diameter*	Part Number				
							Tol.	Tol.	Tol.	Tol.
1.000	+0.000/-0.002	1.365	+0.002/-0.000	0.218	1.135	+0.002/-0.000	0.275	1.001	+0.002/-0.000	4300AY01000
1.125	+0.000/-0.002	1.490	+0.002/-0.000	0.218	1.260	+0.002/-0.000	0.275	1.126	+0.002/-0.000	4300AY01125
1.250	+0.000/-0.002	1.615	+0.002/-0.000	0.218	1.385	+0.002/-0.000	0.275	1.251	+0.002/-0.000	4300AY01250
1.375	+0.000/-0.002	1.740	+0.002/-0.000	0.218	1.510	+0.002/-0.000	0.275	1.376	+0.002/-0.000	4300AY01375
1.500	+0.000/-0.002	1.865	+0.002/-0.000	0.218	1.635	+0.002/-0.000	0.275	1.501	+0.002/-0.000	4300AY01500
1.625	+0.000/-0.002	1.990	+0.002/-0.000	0.218	1.760	+0.002/-0.000	0.275	1.626	+0.002/-0.000	4300AY01625
1.750	+0.000/-0.002	2.115	+0.002/-0.000	0.218	1.885	+0.002/-0.000	0.275	1.751	+0.002/-0.000	4300AY01750
1.812	+0.000/-0.002	2.177	+0.002/-0.000	0.218	1.947	+0.002/-0.000	0.275	1.813	+0.002/-0.000	4300AY01812
1.875	+0.000/-0.002	2.240	+0.002/-0.000	0.218	2.010	+0.002/-0.000	0.275	1.876	+0.002/-0.000	4300AY01875
2.000	+0.000/-0.002	2.365	+0.002/-0.000	0.218	2.135	+0.002/-0.000	0.275	2.001	+0.002/-0.000	4300AY02000
2.125	+0.000/-0.003	2.490	+0.003/-0.000	0.218	2.260	+0.003/-0.000	0.275	2.126	+0.003/-0.000	4300AY02125
2.250	+0.000/-0.003	2.745	+0.003/-0.000	0.281	2.385	+0.003/-0.000	0.351	2.251	+0.003/-0.000	4300AY02250
2.375	+0.000/-0.003	2.870	+0.003/-0.000	0.281	2.510	+0.003/-0.000	0.351	2.376	+0.003/-0.000	4300AY02375
2.500	+0.000/-0.003	2.995	+0.003/-0.000	0.281	2.635	+0.003/-0.000	0.351	2.501	+0.003/-0.000	4300AY02500
2.750	+0.000/-0.003	3.245	+0.003/-0.000	0.281	2.885	+0.003/-0.000	0.351	2.751	+0.003/-0.000	4300AY02750
3.000	+0.000/-0.003	3.495	+0.003/-0.000	0.281	3.135	+0.003/-0.000	0.351	3.001	+0.003/-0.000	4300AY03000
3.125	+0.000/-0.003	3.620	+0.003/-0.000	0.281	3.260	+0.003/-0.000	0.351	3.126	+0.003/-0.000	4300AY03125
3.500	+0.000/-0.003	3.995	+0.003/-0.000	0.281	3.635	+0.003/-0.000	0.351	3.501	+0.003/-0.000	4300AY03500
3.750	+0.000/-0.003	4.245	+0.003/-0.000	0.281	3.885	+0.003/-0.000	0.351	3.751	+0.003/-0.000	4300AY03750
4.000	+0.000/-0.003	4.495	+0.003/-0.000	0.281	4.135	+0.003/-0.000	0.351	4.001	+0.003/-0.000	4300AY04000
4.250	+0.000/-0.003	4.745	+0.003/-0.000	0.281	4.385	+0.003/-0.000	0.351	4.251	+0.003/-0.000	4300AY04250
4.500	+0.000/-0.003	4.995	+0.003/-0.000	0.281	4.635	+0.003/-0.000	0.351	4.501	+0.003/-0.000	4300AY04500
4.750	+0.000/-0.003	5.245	+0.003/-0.000	0.281	4.885	+0.003/-0.000	0.351	4.751	+0.003/-0.000	4300AY04750
5.000	+0.000/-0.003	5.495	+0.003/-0.000	0.281	5.135	+0.003/-0.000	0.351	5.001	+0.003/-0.000	4300AY05000
5.500	+0.000/-0.003	5.995	+0.003/-0.000	0.281	5.635	+0.003/-0.000	0.351	5.501	+0.003/-0.000	4300AY05500
5.750	+0.000/-0.003	6.245	+0.003/-0.000	0.281	5.885	+0.003/-0.000	0.351	5.751	+0.003/-0.000	4300AY05750
6.000	+0.000/-0.003	6.495	+0.003/-0.000	0.281	6.135	+0.003/-0.000	0.351	6.001	+0.003/-0.000	4300AY06000
6.250	+0.000/-0.004	6.745	+0.003/-0.000	0.281	6.385	+0.003/-0.000	0.351	6.251	+0.003/-0.000	4300AY06250
6.500	+0.000/-0.004	6.995	+0.003/-0.000	0.281	6.635	+0.003/-0.000	0.351	6.501	+0.003/-0.000	4300AY06500
7.000	+0.000/-0.004	7.495	+0.003/-0.000	0.281	7.135	+0.003/-0.000	0.351	7.001	+0.003/-0.000	4300AY07000
7.500	+0.000/-0.004	7.995	+0.003/-0.000	0.281	7.635	+0.003/-0.000	0.351	7.501	+0.003/-0.000	4300AY07500
8.000	+0.000/-0.004	8.495	+0.003/-0.000	0.281	8.135	+0.003/-0.000	0.351	8.001	+0.003/-0.000	4300AY08000
8.500	+0.000/-0.004	8.995	+0.003/-0.000	0.281	8.635	+0.003/-0.000	0.351	8.501	+0.003/-0.000	4300AY08500
9.000	+0.000/-0.005	9.495	+0.003/-0.000	0.281	9.135	+0.003/-0.000	0.351	9.001	+0.003/-0.000	4300AY09000
9.500	+0.000/-0.005	9.995	+0.003/-0.000	0.281	9.635	+0.003/-0.000	0.351	9.501	+0.003/-0.000	4300AY09500
10.000	+0.000/-0.005	10.495	+0.003/-0.000	0.281	10.135	+0.003/-0.000	0.351	10.001	+0.003/-0.000	4300AY10000

* If used with wear rings, refer to wear ring throat diameter, see [Section 9](#). For custom groove calculations, see [Appendix C](#).

Above table reflects recommended cross-sections for rod diameters shown. Alternate cross-sections and additional sizes may be considered. Consult www.parker.com/eps/FluidPower for hardware specifications, additional cross-sections and sizes, and part number availability. Contact your Parker representative for assistance.

Wiper H and 8600 Profiles

Catalog EPS 5370/USA



H and 8600 Profiles, Performance Double-Lip Wiper

Parker's H and 8600 profile wipers are double-lip excluders sharing identical geometries for combining the actions of rod sealing and wiping. H wipers, available in plastic compounds, are intended for medium pressure hydraulic applications as a redundant rod seal or for low pressure systems as the sole rod seal and wiper. The 8600 profile wiper, available in rubber compounds, is typically used for pneumatic cylinders where lower friction is required. As with the H profile, the 8600 profile can be used with another rod seal or by itself as a dual-acting sealing/wiping unit.

IMPORTANT: When using H and 8600 Profile wipers with other rod seals, it is important to select a rod seal profile that enables pressure relief of fluid into the system, otherwise a pressure trap may form between the wiper and rod seal. Suggested rod profiles are **BT**, **BS**, **B3**, **8400**, **8500** and **E5** u-cups.

Technical Data

Standard Materials	Temperature Range	Surface Speed
P4615A90 (H)	-65°F to +200°F (-54°C to +93°C)	<1.6 ft/s (0.5 m/s)
P5065A88 (H)	-70°F to +200°F (-57°C to +93°C)	<1.6 ft/s (0.5 m/s)
N4181A80 (8600)	-40°F to +250°F (-40°C to +121°C)	<3.3 ft/s (1.0 m/s)



H / 8600 Cross-Section

Alternate Materials: For applications that may require an alternate material, please contact your local Parker Seal representative.

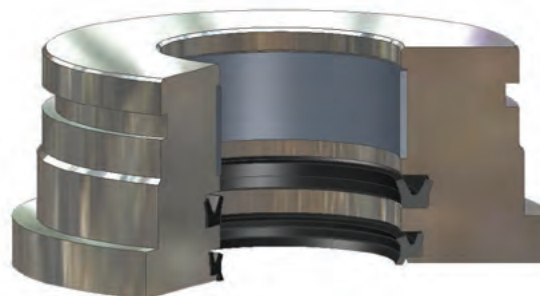

H and 8600 installed in Rod Gland

Part Number Nomenclature — H and 8600 Profiles

Table 8-17. H and 8600 Profiles

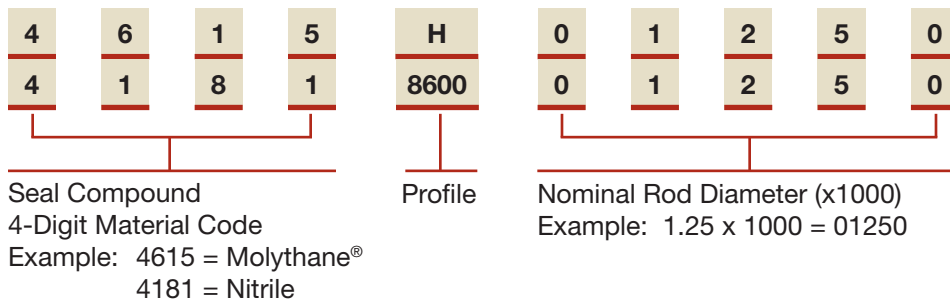

Gland Dimensions — H and 8600 Profiles

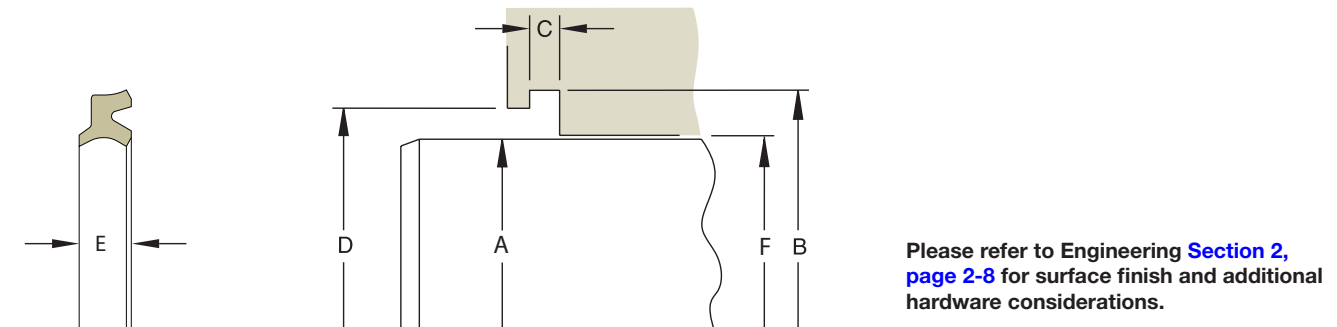

Table 8-18. H and 8600 Profiles — Wiper Gland Calculation

A Rod Diameter		B Groove Diameter	C Groove Width	D Shoulder Diameter	E Max Wiper Axial Width	F Throat Diameter*
Range	Tol.	+0.003/-0.000	+0.005/-0.000	+0.003/-0.000		+0.003/-0.000
0.250 – 0.750	+0.000/-0.002	Dia. A + .302	0.203	Dia. A + .120	0.245	Dia. A + .001
0.812 – 2.125	+0.000/-0.003	Dia. A + .365	0.218	Dia. A + .135	0.275	Dia. A + .001
2.187 – 6.000	+0.000/-0.003	Dia. A + .495	0.281	Dia. A + .135	0.351	Dia. A + .001
6.250 – 8.500	+0.000/-0.004	Dia. A + .495	0.281	Dia. A + .135	0.351	Dia. A + .001
8.750 – 10.000	+0.000/-0.005	Dia. A + .495	0.281	Dia. A + .135	0.351	Dia. A + .001

* If used with wear rings, refer to wear ring throat diameter, see Section 9. For custom groove calculations, see Appendix C.

Above table reflects recommended cross-sections for rod diameters shown. Alternate cross-sections and additional sizes may be considered. Consult www.parker.com/eps/FluidPower for hardware specifications, additional cross-sections and sizes, and part number availability. Contact your Parker representative for assistance.



Wiper AD Profile

Catalog EPS 5370/USA



AD Profile, PTFE Wiper Seal

The Parker AD profile is a double acting wiper for use in low to medium duty hydraulic cylinders. It is a two-piece design comprised of a filled PTFE cap that is energized by a standard size o-ring. The wiping and sealing design of the AD profile assists the primary rod seal in preventing leakage by helping seal fluid in the cylinder when the rod extends. When the cylinder rod retracts, the outside sealing edge prevents contamination from entering the system. Parker's AD profile will retrofit non-Parker wipers of similar design.

The AD profile may be ordered without the energizer. [See part number nomenclature.](#)

Technical Data

Standard Materials

Standard Materials	Temperature Range	Surface Speed
Cap 0401 40% bronze-filled PTFE	-200°F to +575°F -129°C to +302°C	< 5 ft/s (1.5 m/s)
Energizer A 70A Nitrile	-30°F to +250°F (-34°C to +121°C)	

Alternate Materials: For applications that may require an alternate material, please see [Section 3](#) for alternate PTFE ([Table 3-4](#)) and energizer ([Table 3-5](#)) materials.

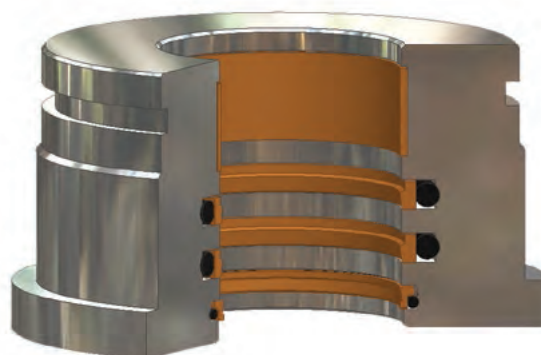
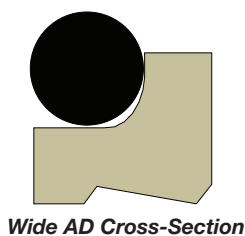

AD installed in Rod Gland

Part Number Nomenclature – AD Profile

Table 8-19. AD Profile

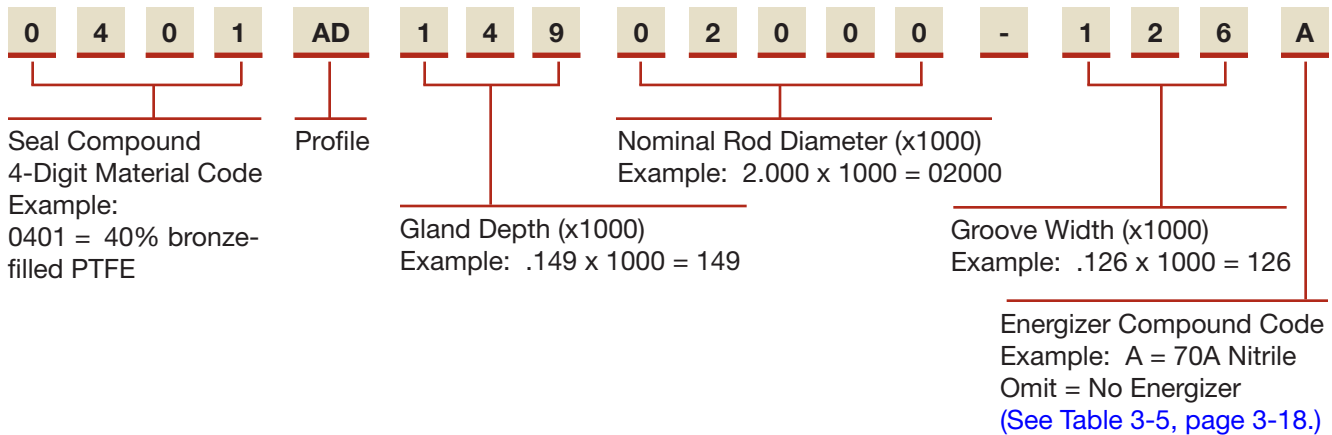

Gland Dimensions – AD Profile

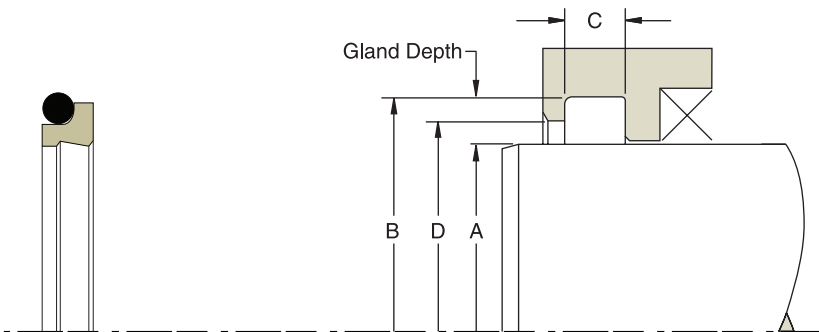

Please refer to Engineering [Section 2](#),
[page 2-8](#) for surface finish and additional
hardware considerations.

Table 8-20. AD Profile – Wiper Gland Calculation (Standard)

A Rod Diameter		Gland Depth	B Groove Diameter		C Groove Width	D Shoulder Diameter		
Range	Tol.		Calculation	Tol.		Shoulder	Tol.	
0.250	1.000	0.095	Dia. A + .190	+0.002/-0.000	0.146	Dia. A + .060	+0.004/-0.000	
0.500	6.000		Dia. A + .270	+0.003/-0.000		0.196	Dia. A + .060	+0.006/-0.000
6.000	10.000		Dia. A + .344	+0.004/-0.000		0.236	Dia. A + .060	+0.008/-0.000
10.000	17.000		Dia. A + .480	+0.005/-0.000		0.332	Dia. A + .080	+0.010/-0.000

* If used with wear rings, refer to wear ring throat diameter, see [Section 9](#). For custom groove calculations, see [Appendix C](#).

Table 8-21. AD Profile – Wiper Gland Calculation (Wide)

A Rod Diameter		Gland Depth	B Groove Diameter		C Groove Width	D Shoulder Diameter		
Range	Tol.		Calculation	Tol.		Shoulder	Tol.	
1.500	2.625	0.173	Dia. A + .248	+0.002/-0.000	0.248	Dia. A + .060	+0.004/-0.000	
2.750	5.375		Dia. A + .480	+0.003/-0.000		0.319	Dia. A + .080	+0.006/-0.000
5.500	15.500		Dia. A + .630	+0.004/-0.000		0.374	Dia. A + .100	+0.008/-0.000
16.000	20.000		Dia. A + .944	+0.005/-0.000		0.551	Dia. A + .100	+0.010/-0.000

* If used with wear rings, refer to wear ring throat diameter, see [Section 9](#). For custom groove calculations, see [Appendix C](#).



Wear Rings / Bearings

Contents

Product Offering 9-3
 Engineering 9-4
 Materials 9-6
 Wear Rings / Bearings Profiles
 ♦ WPT 9-8
 ♦ WRT 9-12
 PDT 9-16
 PDW 9-20

Wear Rings / Bearings

Parker offers a complete line of wear ring and bearing products to fit any application. Expertise in both engineered hard plastics and in PTFE makes Parker the global leader for reciprocating bearing materials. By incorporating premium material blends with precision machining tolerances (down to ± 0.001 "), Parker meets the full spectrum of needs, from heavy-duty hydraulic cylinders operating under the highest temperatures and pressures to pneumatic applications requiring low friction, long life and self-lubrication. Parker wear rings are the best way to combine high performance with value.

Typical Hydraulic Cylinder

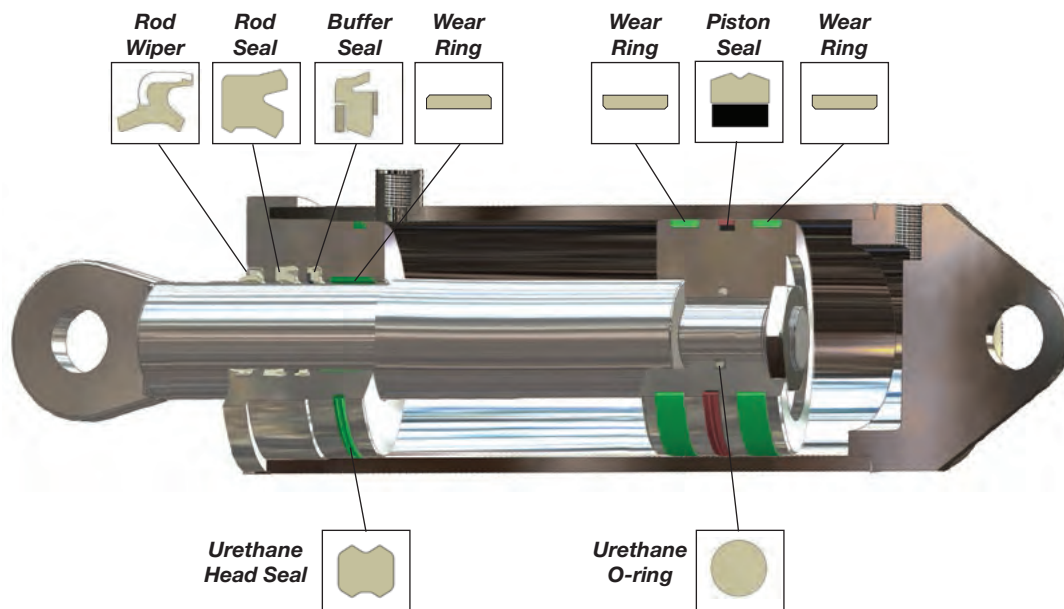

Quality Assurance

All Parker wear ring product lines are manufactured at ISO 9000 registered operations. As such, wear ring production is governed by rigorous quality standards and procedures through a highly trained and qualified workforce. With the assistance of precise, accurate measurement systems and detailed workmanship criteria, Parker delivers first class quality and consistency in every shipment.

Manufacturing Excellence

Parker wear rings utilize a precision manufacturing process that achieves precise flatness on the bearing surfaces, whereas conventional net-molded bearings can form “dog bone” cross-sections. The result is optimal bearing contact area and compressive strength. The cross-sections shown in Figure 9-1 illustrate the differences between these manufacturing methods.

Additionally, available sizing is not limited to existing tooling. *Our processes allow for virtually any width to be produced without assessing a setup charge.*

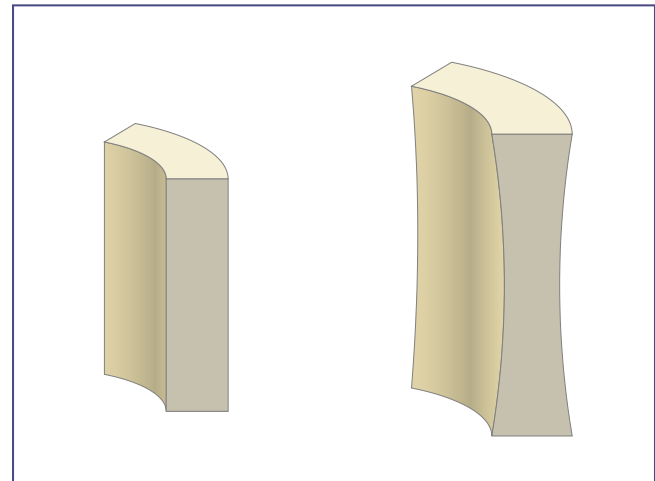

Figure 9-1. Illustrated cross section of Parker wear rings produced by precision manufacturing (left) vs. conventional net molding (right).

Features, Advantages and Benefits

Table 9-1.

Feature	Advantage	Benefit
Dynamic bearing surface contact	Eliminates metal-to-metal contact between components	Prevents rod, piston and seal damage due to scoring and reduces warranty costs
Precision manufactured cross-section	Enables tighter hardware clearances than conventional wear rings	Increases seal life by reducing extrusion gaps associated with conventional wear rings
Low-friction, premium materials	Reduces frictional heat build-up	Lowers operating temperature and increases seal life
Precise flatness on bearing surface	Maximizes bearing contact area and compressive strength, eliminating the “dog bone” effect of conventional net molded wear rings	Prolongs cylinder life through uniform sideload resistance
Advanced, high performance, polymeric materials	Metal particulates and other contaminants can be imbedded in the wear ring material	Protects seals from contamination

06/01/2014











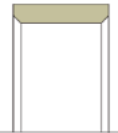

Wear Rings / Bearings Product Offering

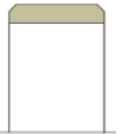
Product Line

No matter what the application demands, Parker's diverse bearing product line ensures that performance requirements are met with maximized value. When pressure and temperature reach their extremes, WPT and WRT profiles help reduce the seal extrusion gap, assuring the utmost seal performance and leakage control. When frictional forces must be kept to a minimum in pneumatic applications, PTFE bearing profiles PDT and PDW provide precision fitting and minimal frictional losses.

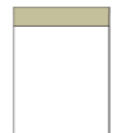
Profiles

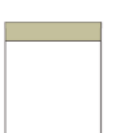
Table 9-2: Product Profiles

Series	Description	Application (Duty)				Page
		Light	Medium	Heavy	Pneumatic	
WPT 	Tight-Tolerance Piston Wear Rings					9-8
WRT 	Tight-Tolerance Rod Wear Rings					9-12
PDT 	PTFE Wear Strip for Rod and Piston					9-16
PDW 	PTFE Machined Wear Rings for Rod and Piston					9-20

Wear Rings / Bearings Engineering

Catalog EPS 5370/USA

FAQs

There are many factors to consider when designing a system. Following are the frequently asked questions regarding bearing design and choosing the right wear ring.

What is the performance difference between standard-tolerance and tight-tolerance wear rings?

Standard-tolerance wear rings have a radial wall tolerance that is held to $\pm 0.0025"$, while tight-tolerance wear rings are held to $\pm 0.001"$ (under 6"). Tight-tolerance wear rings allow for a more precise fit of components, resulting in less dimensional "play." This allows the extrusion gap to be smaller for tight-tolerance wear rings, thus increasing the seal's pressure rating beyond that of standard-tolerance wear rings. This becomes very important at high temperatures, where pressure ratings of materials can further be reduced. Although it is critical to consider every aspect of each application, a general guideline for product selection can be found in [Table 9-2 on page 9-3](#).

Wear ring grooves call for larger extrusion gaps. How does this affect the seals' pressure rating?

Since wear rings are used to eliminate metal-to-metal contact between moving parts, there must be a larger gap between them, thus causing a wider extrusion gap. As a result, the seal's pressure ratings will decrease. Pre-established gland dimensions outlined in this catalog always result in a minimum 0.005" clearance for metal components. As such, standard-tolerance wear rings can reduce a seal's pressure capability by up to 50%. Using tight-tolerance wear rings enables the extrusion gaps to be held closer, and the seal's pressure ratings are only reduced by up to 30%. In either case, it is important to select proper seal and back-up materials to accommodate the increased extrusion gaps. Alternatively, Parker Integrated Pistons™ boost performance by providing all of the benefits of wear rings without any increase in extrusion gap whatsoever.

For applications where the seals will be stressed toward their maximum capabilities, gland dimensions can be developed using the equations that accompany each profile. Use these equations to apply desired machining tolerances and clearances. It is critical when determining metal-to-metal clearances to consider the material's compressive properties, which can be found on [page 9-7](#). It is equally important to evaluate how the applied tolerances will affect the seals' extrusion gap. Please contact Parker or your authorized distributor for assistance in developing alternate gland dimensions.

How is a proper bearing width selected?

When selecting a bearing width, it is crucial to evaluate the side loads that the bearings will have to withstand. Figure 9-2 shows the total pressure area, A_p , that a radial force from a side load will affect. Area, A_p is calculated as follows:

$$A_p = \text{Ø}D \times W$$

where D is the bearing O.D. for pistons or the bearing I.D. for rods, and W is the bearing width.

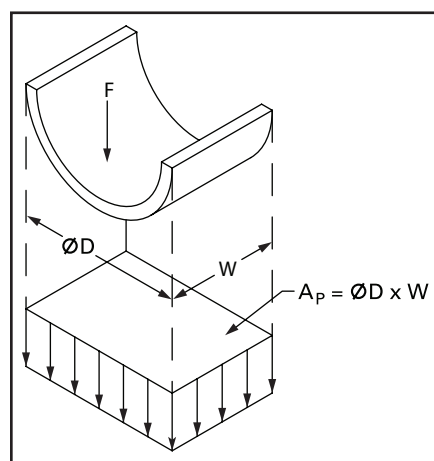

Figure 9-2: Total affected pressure area, A_p

It is important to note that the pressure distribution will not be equally dispersed across this area. Instead, the pressure profile takes the form shown in Figure 9-3. The assumed load-bearing area, A_L , can be calculated as follows:

$$A_L = \frac{A_p}{5} = \frac{\text{Ø}D \times W}{5}$$

To calculate the allowable radial force, F , simply multiply the load-bearing area, A_L , by the permissible compressive load (compressive strength) of the material, q , and divide by the desired factor of safety, FS .

To calculate the proper bearing width, W , based on a known radial force:

$$W = \frac{5 \times F}{\text{Ø}D \times q} \times FS$$

Once W is calculated, round up to the next nominal width (1/8" increments).

To calculate the allowable radial force, F , based on a known bearing width:

$$F = \frac{A_L \times q}{FS} = \frac{\text{Ø}D \times W \times q}{5 \times FS}$$

Compressive Strength, q , can be found in the material properties tables on [page 9-7](#). This value is based upon known material deflection at 73°F and at a specified load. Parker recommends a factor of safety, FS , of at least 3 to account for changes in physical properties due to increases in system

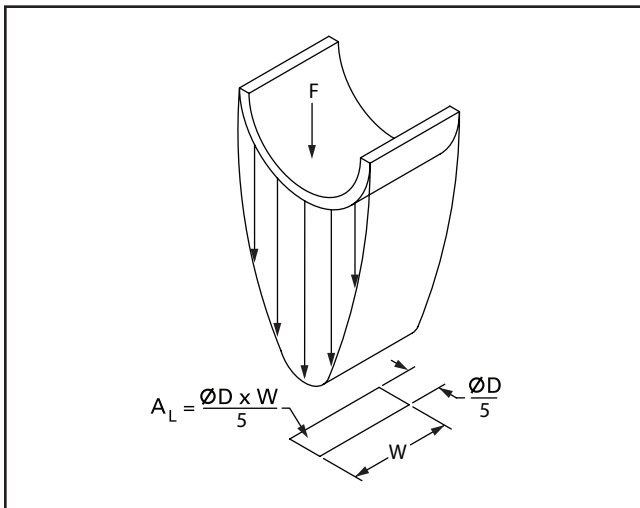

Figure 9-3: Load distribution of radial force, F , and effective load area, A_L

temperature. If additional assistance is required, please contact Parker or your authorized distributor.

What about fluid compatibility and wear rings?

MolyGard® and WearGard™ compounds are compatible with petroleum-based hydraulic fluids, transmission fluids, phosphate esters, and many other fluids. PTFE compounds 0401, 0307, and others have outstanding chemical compatibility with a wide range of fluids. Please contact Parker for specific inquiries.

How does moisture affect wear rings?

Due to nylon's inherent swelling in water, it is recommended that WearGard and MolyGard not be used in applications where water or moisture is present. Filled PTFE compounds or other alternative materials such as polyacetal and composite resins are recommended in such scenarios and are available from Parker.

Where should the wear ring be installed relative to the seals?

Wear rings should always be installed on the lubrication (wet) side of the seal for best performance. For rod glands, the wear ring should be on the pressure side of the rod seal. For pistons, if only one bearing is to be used, it should be on the side of the piston opposite the rod. This arrangement keeps the piston wear ring further away from the rod wear ring. This becomes critical when the rod is at full extension and provides better leveraging of the two bearing surfaces.

Which end cut should be used?

There are three types of end cuts available: butt cut, angle cut (skive cut) and step cut. The butt cut is the most common and most economical cut. Angle cuts and step cuts provide added performance by ensuring bearing area overlap at the wear ring's gap. In certain applications, step cut wear rings can be used as buffer seals, protecting the seal from pressure spikes. Figure 9-4 illustrates these options.

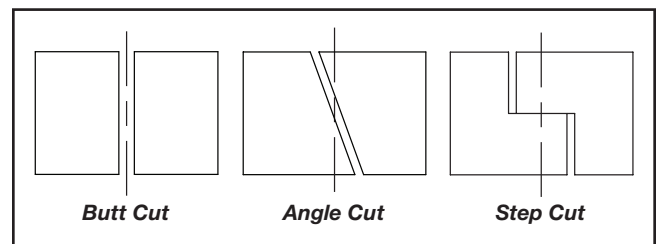
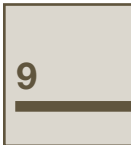

Figure 9-4: End cuts



Wear Rings / Bearings Materials

Catalog EPS 5370/USA



Parker Wear Ring / Bearing Materials

Parker's material offering for wear ring and bearing materials is anchored by over 50 years of manufacturing and material science expertise. We have specifically engineered our W4733 WearGard™ for strength to meet or exceed the characteristics of many metals which have traditionally been used in wear rings.

While many compounds are available, the most commonly used bearing materials are WearGard and filled PTFE.

Parker also offers other engineered bearing materials for specialized applications demanding higher temperatures and sideloads. Parker's W4738 UltraComp™ CGT (PEEK) provides high temperature bearing performance up to 500°F. Composite, fabric-reinforced resins are also available to accommodate sideloads far more severe than glass-loaded nylon compounds can withstand. Composite resins also resist moisture swell in water-glycol emulsions and other water-based fluids. Polyacetal, nylons, molybdenum disulfide, and many different PTFE filler combinations are also available for specialized applications. Please contact Parker or your authorized distributor for assistance in selecting alternative bearing materials.

Table 9-3. Physical and Mechanical Properties of Engineered Plastics

Property	Unit	W4733	W4738	Test Method
		WearGard™ 35% Glass-Reinforced Nylon	UltraCOMP™ CGT (PEEK®) Carbon-, Graphite-, PTFE-filled	
Compressive Strength, <i>q</i>	psi	21500	21700	ASTM D695, 73°F
Tensile Strength	psi	18300	20400	ASTM D638, 73°F
Tensile Modulus	Kpsi	899	—	ASTM D638, 73°F
Shear Strength	psi	9820	—	ASTM D732, 73°F
Flexural Strength	psi	25500	33400	ASTM D790, 73°F
Flexural Modulus	Kpsi	1100	1175	ASTM D790, 73°F
Notched IZOD Impact Strength	Ft-Lbs/in	1.15	1.69	ASTM D256, 73°F
Deformation Under Load	%	0.40	—	ASTM D621, 24 hrs @ 4000 psi, 73°F
Water Absorption	%	0.50 to 0.70	0.06	24 hour immersion, ASTM D570, 73°F
Temperature Range	°F	-65 to +275	-65 to +500	—
Rockwell Hardness	M Scale	87	100	ASTM D785
	R Scale	117	—	ASTM D785

Table 9-4. Physical and Mechanical Properties of PTFE Compounds

Property	Unit	0401	0307	Test Method
		40% Bronze- Filled PTFE	23% Carbon-, 2% Graphite- Filled PTFE	
Compressive Strength, <i>q</i>	psi	9400	3600	ASTM D695, 73°F
Tensile Strength	psi	3200	2250	ASTM D1457-81A
Elongation	%	250	100	ASTM D4894
Deformation Under Load	%	4.4	2.5	ASTM D621, 24 hrs @ 2000 psi, 70°F
Coefficient of Friction	—	0.18 - 0.22	0.08 - 0.11	ASTM D3702
Temperature Range	°F	-200 to +575	-360 to +575	—
Shore D Hardness	—	63	64	ASTM D2240-75

Table 9-5. Physical and Mechanical Properties of Composite Fabric-Reinforced Resins

Property	Unit	0810	0811	0812	0813	Test Method
		Standard Polyester Based with PTFE	Graphite- Filled Polyester Based	MoS ₂ - Filled Polyester Based	PTFE-Filled Polyester Based	
Compressive Strength, <i>q</i>	psi	50000	50000	50000	50000	ASTM D695, 73°F
Tensile Strength	psi	11000	11000	11000	11000	ASTM D638, 73°F
Tensile Modulus	Kpsi	500	500	500	500	ASTM D638, 73°F
Coefficient of Friction	—	0.13 - 0.20	0.15 - 0.20	0.15 - 0.20	0.13 - 0.20	ASTM D790, 73°F
Water Absorption	%	0.1	0.1	0.1	0.1	24 hour immersion, ASTM D570, 73°F
Temperature Range	°F	-40 to +200	-40 to +200	-40 to +400	-40 to +400	—
Rockwell M Hardness	—	100	100	100	100	ASTM D785

Wear Ring / Bearing

WPT Profile

◆ Preferred Profile

Catalog EPS 5370/USA

WPT profile tight-tolerance piston wear rings are the premier bearings for light- to heavy-duty hydraulic applications. WPT profile wear rings are available in standard sizes from 1" up to 12" bore diameters (larger sizes upon request). WPT profile wear rings feature chamfered corners on the I.D. and are designed to snap closed during assembly to hold tight against the piston, eliminating bore interference and simplifying installation.

WPT Profile, Tight-Tolerance Piston Wear Ring

Technical Data

Standard Material
W4733 WearGard™

Radial Tolerance
+ .000" / - .002" (up to 6" O.D.); + .000 / - .003" (6" to 12" O.D.)

End Cuts

Butt Cut, Angle Cut (Skive Cut), Step Cut

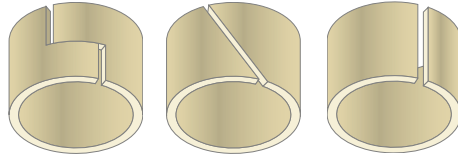

Options

Virtually any width can be produced without assessing a setup charge. Additionally, other cross-sections not shown are available when required.

WPT Cross-Section

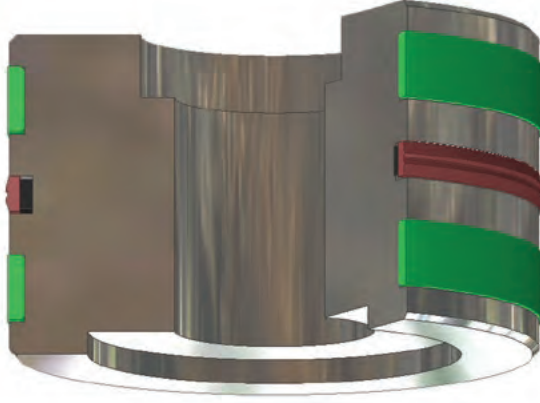
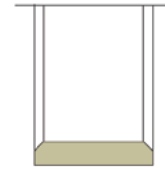

Piston sealing system comprised of WPT wear rings and BP bi-directional piston seal

Click to Go to SECTION Table of Contents

Click to Go to CATALOG Table of Contents

Part Number Nomenclature – WPT Profile

Table 9-6. WPT Profile

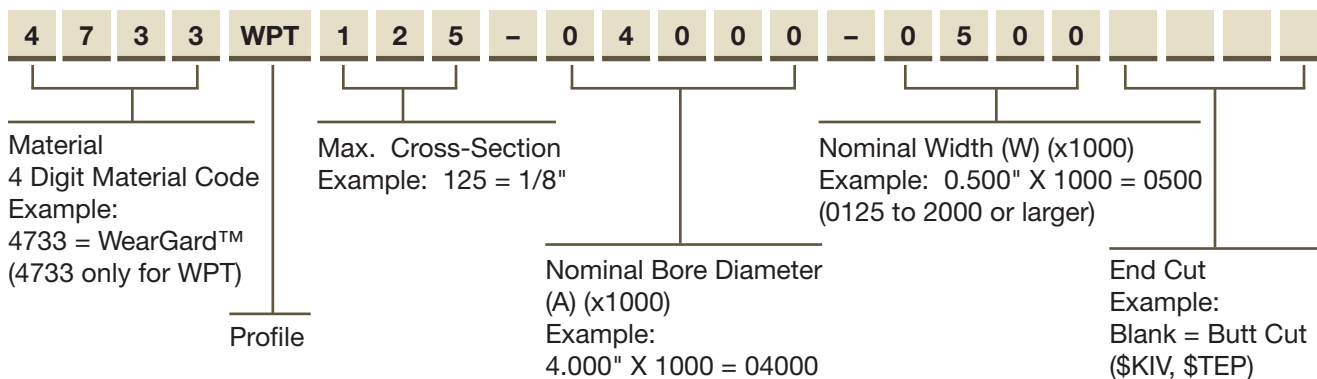

Gland Dimensions – WPT Profile

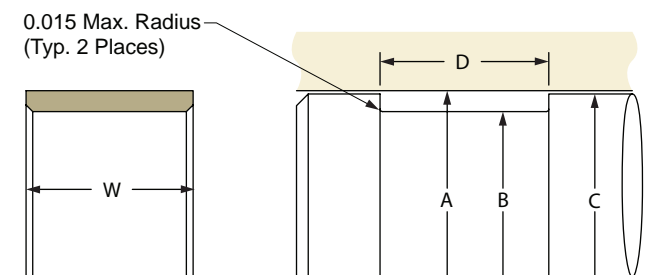

Please refer to Engineering [Section 2](#), [page 2-8](#) for surface finish and additional hardware considerations.

Table 9-7. WPT Profile – Piston Gland Calculation

A Bore Diameter		B Groove Diameter		C Piston Diameter		D Groove Width
Range	Tol.	Calculation	Tol.	Calculation	Tol.	Calculation
.125 Cross Section						
1.000 - 4.875	+ .002/- .000	Dia. A - .251	+ .000/- .002	Dia. A - .017	+ .000/- .002	D = W + 0.010
5.000 - 7.500	+ .004/- .000	Dia. A - .251	+ .000/- .003	Dia. A - .018	+ .000/- .003	D = W + 0.010
7.500 - 12.000	+ .006/- .000	Dia. A - .251	+ .000/- .004	Dia. A - .021	+ .000/- .004	D = W + 0.010
.062 Cross Section						
0.875 - 5.625	+ .002/- .000	Dia. A - .125	+ .000/- .002	Dia. A - .017	+ .000/- .002	D = W + 0.010

For custom groove calculations, see [Appendix C](#).

NOTE: For sizes larger than those shown in the table, please contact your local Parker representative.

Gland Dimensions – WPT Profile

Table 9-8. WPT Profile – Piston Gland Dimensions, ♦Parker Standard Sizes

Hardware Dimensions				Part Number
A Bore Diameter	B Groove Diameter	C Piston Diameter	D Groove Width	
+ .002/- .000	+ .000/- .002	+ .000/- .002	+ .010/- .000	
1.000	0.875	0.983	D = W + 0.010	4733WPT062-01000-XXXX
1.125	1.000	1.108	D = W + 0.010	4733WPT062-01125-XXXX
1.250	1.125	1.233	D = W + 0.010	4733WPT062-01250-XXXX
1.375	1.250	1.358	D = W + 0.010	4733WPT062-01375-XXXX
1.500	1.375	1.483	D = W + 0.010	4733WPT062-01500-XXXX
1.625	1.500	1.608	D = W + 0.010	4733WPT062-01625-XXXX
1.750	1.625	1.733	D = W + 0.010	4733WPT062-01750-XXXX
1.875	1.750	1.858	D = W + 0.010	4733WPT062-01875-XXXX
2.375	2.250	2.358	D = W + 0.010	4733WPT062-02375-XXXX
2.625	2.500	2.608	D = W + 0.010	4733WPT062-02625-XXXX
+ .002/- .000	+ .000/- .002	+ .000/- .002	+ .010/- .000	
1.000	0.749	0.983	D = W + 0.010	4733WPT125-01000-XXXX
1.125	0.874	1.108	D = W + 0.010	4733WPT125-01125-XXXX
1.250	0.999	1.233	D = W + 0.010	4733WPT125-01250-XXXX
1.375	1.124	1.358	D = W + 0.010	4733WPT125-01375-XXXX
1.500	1.249	1.483	D = W + 0.010	4733WPT125-01500-XXXX
1.625	1.374	1.608	D = W + 0.010	4733WPT125-01625-XXXX
1.750	1.499	1.733	D = W + 0.010	4733WPT125-01750-XXXX
1.875	1.624	1.858	D = W + 0.010	4733WPT125-01875-XXXX
+ .002/- .000	+ .000/- .002	+ .000/- .002	+ .010/- .000	
2.000	1.749	1.983	D = W + 0.010	4733WPT125-02000-XXXX
2.125	1.874	2.108	D = W + 0.010	4733WPT125-02125-XXXX
2.250	1.999	2.233	D = W + 0.010	4733WPT125-02250-XXXX
2.375	2.124	2.358	D = W + 0.010	4733WPT125-02375-XXXX
2.500	2.249	2.483	D = W + 0.010	4733WPT125-02500-XXXX
2.625	2.374	2.608	D = W + 0.010	4733WPT125-02625-XXXX
2.750	2.499	2.733	D = W + 0.010	4733WPT125-02750-XXXX
2.875	2.624	2.858	D = W + 0.010	4733WPT125-02875-XXXX
3.000	2.749	2.983	D = W + 0.010	4733WPT125-03000-XXXX
3.125	2.874	3.108	D = W + 0.010	4733WPT125-03125-XXXX
3.250	2.999	3.233	D = W + 0.010	4733WPT125-03250-XXXX
3.375	3.124	3.358	D = W + 0.010	4733WPT125-03375-XXXX
3.500	3.249	3.483	D = W + 0.010	4733WPT125-03500-XXXX
3.625	3.374	3.608	D = W + 0.010	4733WPT125-03625-XXXX
3.750	3.499	3.733	D = W + 0.010	4733WPT125-03750-XXXX
3.875	3.624	3.858	D = W + 0.010	4733WPT125-03875-XXXX
3.937	3.687	3.920	D = W + 0.010	4733WPT125-03937-XXXX

Above table reflects recommended cross-sections for bore diameters shown. Alternate cross-sections and additional sizes may be considered. Consult www.parker.com/eps/FluidPower for additional cross-sections and sizes, hardware specifications, and part number availability. Contact your Parker representative for assistance.

Gland Dimensions – WPT Profile

Table 9-8. WPT Profile – Piston Gland Dimensions, ♦Parker Standard Sizes (cont'd)

Hardware Dimensions				Part Number
A Bore Diameter	B Groove Diameter	C Piston Diameter	D Groove Width	
+0.002/-0.000	+0.000/-0.002	+0.000/-0.002	+0.010/-0.000	
4.000	3.749	3.983	D = W + 0.010	4733WPT125-04000-XXXX
4.125	3.874	4.108	D = W + 0.010	4733WPT125-04125-XXXX
4.250	3.999	4.233	D = W + 0.010	4733WPT125-04250-XXXX
4.375	4.124	4.358	D = W + 0.010	4733WPT125-04375-XXXX
4.500	4.249	4.483	D = W + 0.010	4733WPT125-04500-XXXX
4.625	4.374	4.608	D = W + 0.010	4733WPT125-04625-XXXX
4.750	4.499	4.733	D = W + 0.010	4733WPT125-04750-XXXX
4.875	4.624	4.858	D = W + 0.010	4733WPT125-04875-XXXX
+0.004/-0.000	+0.000/-0.003	+0.000/-0.003	+0.010/-0.000	
5.000	4.749	4.982	D = W + 0.010	4733WPT125-05000-XXXX
5.125	4.874	5.107	D = W + 0.010	4733WPT125-05125-XXXX
5.250	4.999	5.232	D = W + 0.010	4733WPT125-05250-XXXX
5.375	5.124	5.357	D = W + 0.010	4733WPT125-05375-XXXX
5.500	5.249	5.482	D = W + 0.010	4733WPT125-05500-XXXX
5.625	5.374	5.607	D = W + 0.010	4733WPT125-05625-XXXX
5.750	5.499	5.732	D = W + 0.010	4733WPT125-05750-XXXX
6.000	5.749	5.980	D = W + 0.010	4733WPT125-06000-XXXX
6.250	5.999	6.230	D = W + 0.010	4733WPT125-06250-XXXX
6.500	6.249	6.480	D = W + 0.010	4733WPT125-06500-XXXX
6.750	6.499	6.730	D = W + 0.010	4733WPT125-06750-XXXX
7.000	6.749	6.980	D = W + 0.010	4733WPT125-07000-XXXX
7.500	7.249	7.480	D = W + 0.010	4733WPT125-07500-XXXX
+0.006/-0.000	+0.000/-0.004	+0.000/-0.004	+0.010/-0.000	
8.000	7.749	7.979	D = W + 0.010	4733WPT125-08000-XXXX
8.500	8.249	8.479	D = W + 0.010	4733WPT125-08500-XXXX
+0.006/-0.000	+0.000/-0.004	+0.000/-0.004	+0.010/-0.000	
9.000	8.749	8.979	D = W + 0.010	4733WPT125-09000-XXXX
9.500	9.249	9.479	D = W + 0.010	4733WPT125-09500-XXXX
10.000	9.749	9.979	D = W + 0.010	4733WPT125-10000-XXXX
10.500	10.249	10.479	D = W + 0.010	4733WPT125-10500-XXXX
+0.006/-0.000	+0.000/-0.004	+0.000/-0.004	+0.010/-0.000	
11.000	10.749	10.979	D = W + 0.010	4733WPT125-11000-XXXX
11.500	11.249	11.479	D = W + 0.010	4733WPT125-11500-XXXX
12.000	11.749	11.979	D = W + 0.010	4733WPT125-12000-XXXX

Above table reflects recommended cross-sections for bore diameters shown. Alternate cross-sections and additional sizes may be considered. Consult www.parker.com/eps/FluidPower for additional cross-sections and sizes, hardware specifications, and part number availability. Contact your Parker representative for assistance.

Wear Ring / Bearing

WRT Profile

Catalog EPS 5370/USA



WRT Profile, Tight-Tolerance Rod Wear Ring

WRT profile tight-tolerance rod wear rings, when combined with the WPT profile, complete the premier cylinder bearing system. Recommended for light- to heavy-duty hydraulic applications, they are available in standard sizes from 7/8" up to 7" rod diameters (larger sizes upon request). WRT profile wear rings feature chamfered corners on the O.D. and are designed to snap open during assembly to hold tight against the head gland, eliminating rod interference and simplifying installation.

Technical Data

Standard Material
W4733 WearGard™

Radial Tolerance
+.000"/-.002" (up to 5-3/4" I.D.); +.000"/-.003" (5-3/4" to 7" I.D.)

End Cuts

Butt Cut, Angle Cut (Skive Cut), Step Cut

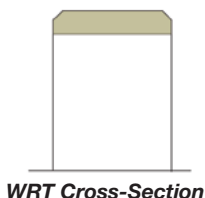
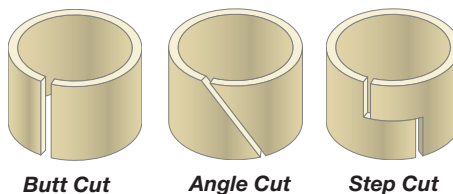

WRT Cross-Section

Options

Virtually any width can be produced without assessing a setup charge. Additionally, other cross-sections not shown are available when required.

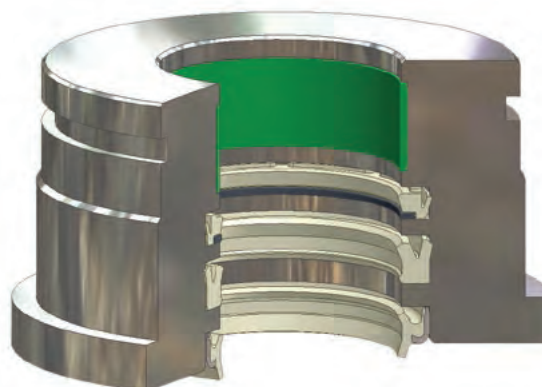

*Rod sealing system comprised of
WRT wear ring, BR buffer ring assembly, BT u-cup and AH canned wiper*

Part Number Nomenclature – WRT Profile

Table 9-9. WRT Profile

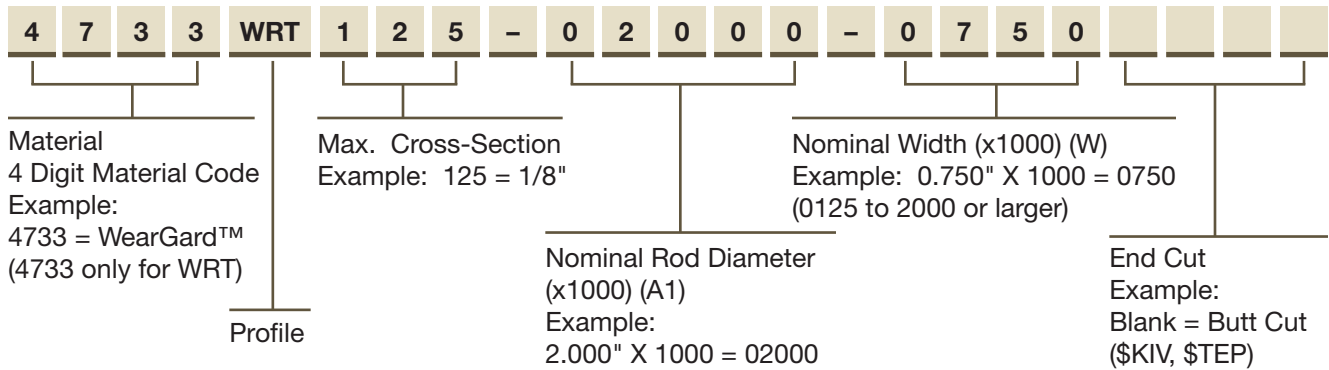

Gland Dimensions – WRT Profile

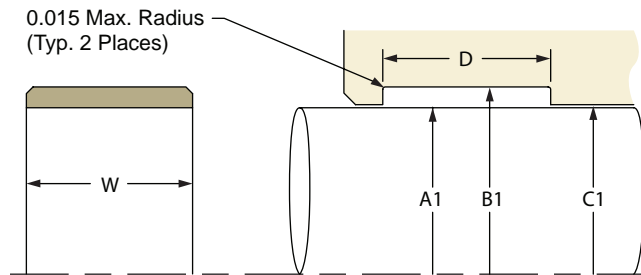

Please refer to Engineering [Section 2](#), [page 2-8](#) for surface finish and additional hardware considerations.

Table 9-10. WRT Profile – Rod Gland Calculation

A1 Rod Diameter		B1 Groove Diameter		C1 Throat Diameter		D Groove Width
Range	Tol.	Calculation	Tol.	Calculation	Tol.	Calculation
.125 Cross Section						
.750-5.625	+ .000/- .002	Dia. A + .251	+ .002/- .000	Dia. A + .017	+ .002/- .000	D = W + 0.010"
5.625-7	+ .000/- .004	Dia. A + .251	+ .003/- .000	Dia. A + .020	+ .003/- .000	D = W + 0.010"
7-12	+ .000/- .006	Dia. A + .251	+ .004/- .000	Dia. A + .021	+ .004/- .000	D = W + 0.010"
.062 Cross Section						
0.875 - 5.625	+ .002/- .000	Dia. A + .125	+ .002/- .000	Dia. A + .017	+ .002/- .000	D = W + 0.010"

For custom groove calculations, see [Appendix C](#).

NOTE: For sizes larger than those shown in the table, please contact your local Parker representative.

Gland Dimensions – WRT Profile

Table 9-11. WRT Profile – Rod Gland Dimensions, ♦Parker Standard Sizes

Hardware Dimensions				Part Number
A1 Rod Diameter	B1 Groove Diameter	C1 Throat Diameter	D Groove Width	
+ .000/- .002	+ .002/- .000	+ .002/- .000	+ .010/- .000	
0.875	1.000	0.892	D = W + 0.010	4733WRT062-00875-XXXX
1.000	1.125	1.017	D = W + 0.010	4733WRT062-01000-XXXX
1.125	1.250	1.142	D = W + 0.010	4733WRT062-01125-XXXX
1.250	1.375	1.267	D = W + 0.010	4733WRT062-01250-XXXX
1.375	1.500	1.392	D = W + 0.010	4733WRT062-01375-XXXX
1.500	1.625	1.517	D = W + 0.010	4733WRT062-01500-XXXX
1.625	1.750	1.642	D = W + 0.010	4733WRT062-01625-XXXX
1.750	1.875	1.767	D = W + 0.010	4733WRT062-01750-XXXX
2.250	2.375	2.267	D = W + 0.010	4733WRT062-02250-XXXX
2.500	2.625	2.517	D = W + 0.010	4733WRT062-02250-XXXX
+ .000/- .002	+ .002/- .000	+ .002/- .000	+ .010/- .000	
0.750	1.001	0.767	D = W + 0.010	4733WRT125-00750-XXXX
0.875	1.126	0.892	D = W + 0.010	4733WRT125-00875-XXXX
1.000	1.251	1.017	D = W + 0.010	4733WRT125-01000-XXXX
1.125	1.376	1.142	D = W + 0.010	4733WRT125-01125-XXXX
1.250	1.501	1.267	D = W + 0.010	4733WRT125-01250-XXXX
1.375	1.626	1.392	D = W + 0.010	4733WRT125-01375-XXXX
1.500	1.751	1.517	D = W + 0.010	4733WRT125-01500-XXXX
1.625	1.876	1.642	D = W + 0.010	4733WRT125-01625-XXXX
1.750	2.001	1.767	D = W + 0.010	4733WRT125-01750-XXXX
1.875	2.126	1.892	D = W + 0.010	4733WRT125-01875-XXXX
+ .000/- .002	+ .002/- .000	+ .002/- .000	+ .010/- .000	
2.000	2.251	2.017	D = W + 0.010	4733WRT125-02000-XXXX
2.125	2.376	2.142	D = W + 0.010	4733WRT125-02125-XXXX
2.250	2.501	2.267	D = W + 0.010	4733WRT125-02250-XXXX
2.375	2.626	2.392	D = W + 0.010	4733WRT125-02375-XXXX
2.500	2.751	2.517	D = W + 0.010	4733WRT125-02500-XXXX
2.625	2.876	2.642	D = W + 0.010	4733WRT125-02625-XXXX
2.750	3.001	2.767	D = W + 0.010	4733WRT125-02750-XXXX
2.875	3.126	2.892	D = W + 0.010	4733WRT125-02875-XXXX
3.000	3.251	3.017	D = W + 0.010	4733WRT125-03000-XXXX
3.125	3.376	3.142	D = W + 0.010	4733WRT125-03125-XXXX
3.250	3.501	3.267	D = W + 0.010	4733WRT125-03250-XXXX
3.375	3.626	3.392	D = W + 0.010	4733WRT125-03375-XXXX
3.500	3.751	3.517	D = W + 0.010	4733WRT125-03500-XXXX
3.625	3.876	3.642	D = W + 0.010	4733WRT125-03625-XXXX
3.750	4.001	3.767	D = W + 0.010	4733WRT125-03750-XXXX

Above table reflects recommended cross-sections for rod diameters shown. Alternate cross-sections and additional sizes may be considered. Consult www.parker.com/eps/FluidPower for additional cross-sections and sizes, hardware specifications, and part number availability. Contact your Parker representative for assistance.

Gland Dimensions – WRT Profile
Table 9-11. WRT Profile – Rod Gland Dimensions, ♦Parker Standard Sizes (cont'd)

A1 Rod Diameter	Hardware Dimensions			D Groove Width	Part Number
	B1 Groove Diameter	C1 Throat Diameter	D Groove Width		
+0.00/-0.002	+0.002/-0.000	+0.002/-0.000	+0.010/-0.000		
3.875	4.126	3.892	D = W + 0.010	4733WRT125-03875-XXXX	
3.937	4.188	3.954	D = W + 0.010	4733WRT125-03937-XXXX	
4.000	4.251	4.017	D = W + 0.010	4733WRT125-04000-XXXX	
4.125	4.376	4.142	D = W + 0.010	4733WRT125-04125-XXXX	
4.250	4.501	4.267	D = W + 0.010	4733WRT125-04250-XXXX	
4.375	4.626	4.392	D = W + 0.010	4733WRT125-04375-XXXX	
4.500	4.751	4.517	D = W + 0.010	4733WRT125-04500-XXXX	
4.625	4.876	4.642	D = W + 0.010	4733WRT125-04625-XXXX	
4.750	5.001	4.767	D = W + 0.010	4733WRT125-04750-XXXX	
4.875	5.126	4.892	D = W + 0.010	4733WRT125-04875-XXXX	
5.000	5.251	5.017	D = W + 0.010	4733WRT125-05000-XXXX	
5.125	5.376	5.142	D = W + 0.010	4733WRT125-05125-XXXX	
5.250	5.501	5.267	D = W + 0.010	4733WRT125-05250-XXXX	
5.375	5.626	5.392	D = W + 0.010	4733WRT125-05375-XXXX	
5.500	5.751	5.517	D = W + 0.010	4733WRT125-05500-XXXX	
5.625	5.876	5.642	D = W + 0.010	4733WRT125-05625-XXXX	
+0.000/-0.004	+0.003/-0.000	+0.003/-0.000	+0.010/-0.000		
5.750	6.001	5.770	D = W + 0.010	4733WRT125-05750-XXXX	
6.000	6.251	6.020	D = W + 0.010	4733WRT125-06000-XXXX	
6.250	6.501	6.270	D = W + 0.010	4733WRT125-06250-XXXX	
6.500	6.751	6.520	D = W + 0.010	4733WRT125-06500-XXXX	
6.750	7.001	6.770	D = W + 0.010	4733WRT125-06750-XXXX	
7.000	7.251	7.020	D = W + 0.010	4733WRT125-07000-XXXX	

Above table reflects recommended cross-sections for rod diameters shown. Alternate cross-sections and additional sizes may be considered. Consult www.parker.com/eps/FluidPower for additional cross-sections and sizes, hardware specifications, and part number availability. Contact your Parker representative for assistance.

Wear Ring / Bearing PDT Profile

Catalog EPS 5370/USA

PDT Profile, PTFE Wear Strip for Rod and Piston



PDT profile wear strip is available in a variety of PTFE blends and provides excellent low-friction performance in pneumatics and light-duty hydraulics. PDT profile wear strip is available in cut-to-length versions as well as bulk strip. Cut-to-length part numbers reduce prep time by providing precision end cuts and ready-to-install diameters. Bulk strip offers versatility and reduces part number inventory by providing universal sizing in one part number.

Technical Data

Standard Material

0401 – 40% Bronze-Filled PTFE

0307 – 23% Carbon, 2% Graphite-Filled PTFE

Others available upon request

Radial Tolerance

+0.000"/-0.004"

End Cuts

Butt Cut, Angle Cut (Skive Cut), Step Cut

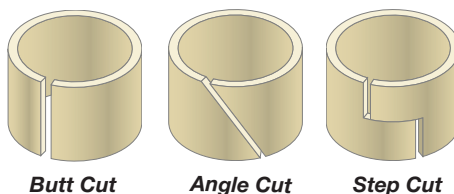
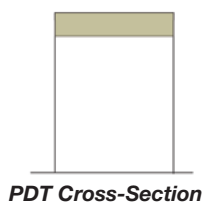

Options

Virtually any width, diameter and cross-section can be produced without assessing a setup charge.

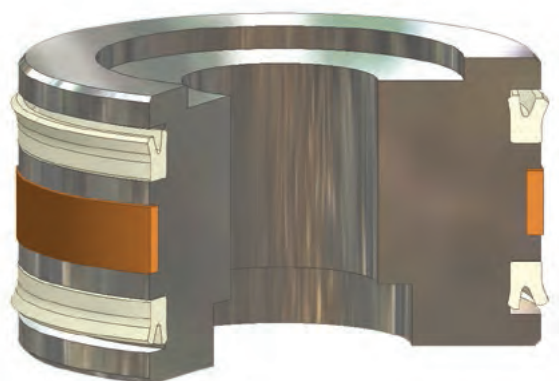

Piston sealing system comprised of PDT wear strip and B7 piston u-cups

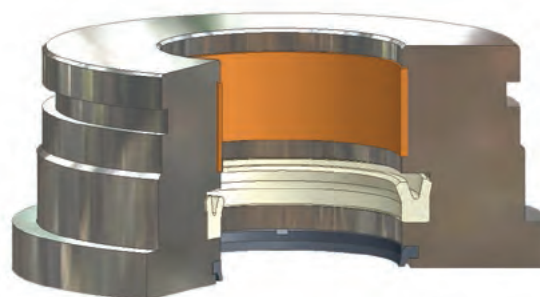

Rod sealing system comprised of PDT wear strip, B3 rod u-cup and SH959 wiper

06/01/2014

Part Number Nomenclature – PDT Profile

Table 9-12. PDT Profile – Cut-to-Length

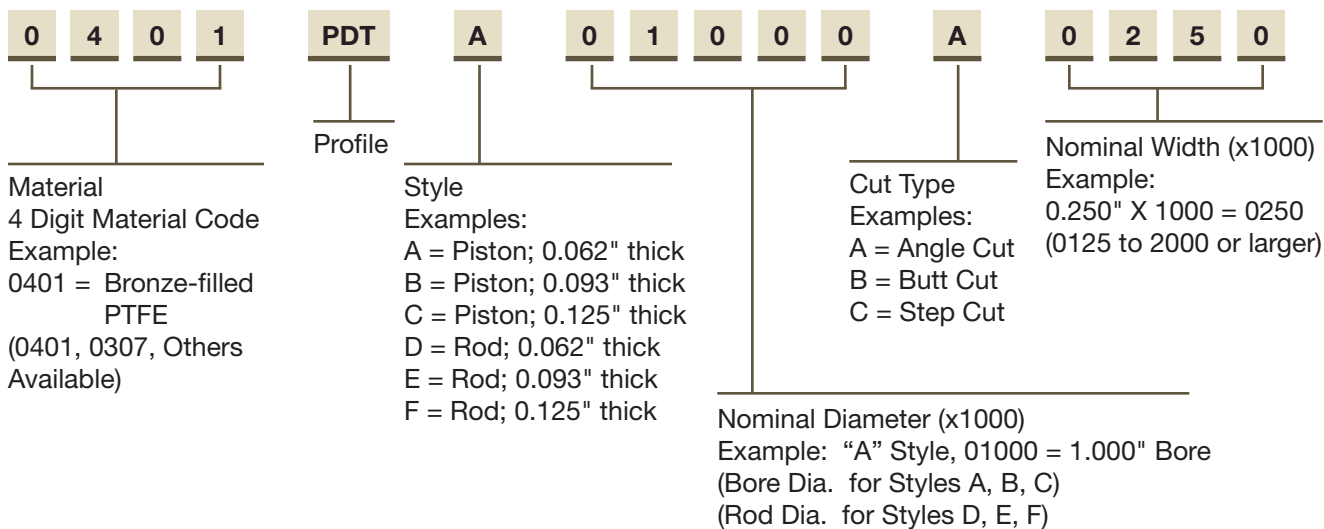
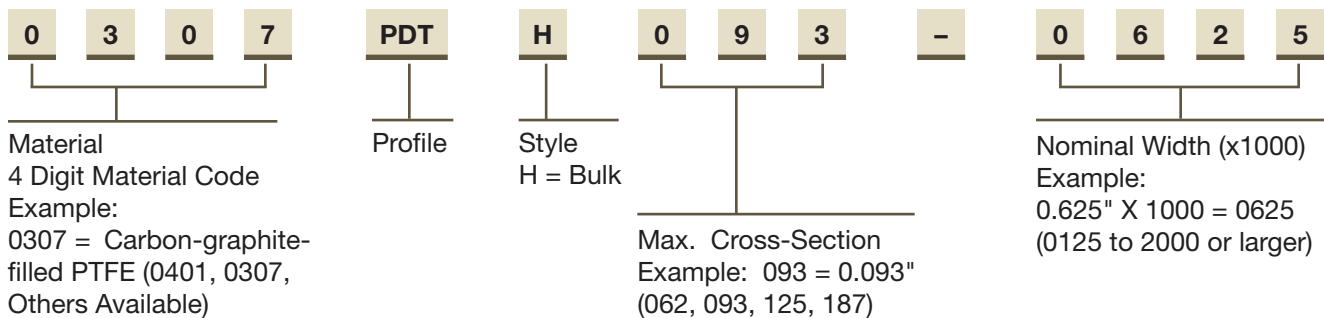
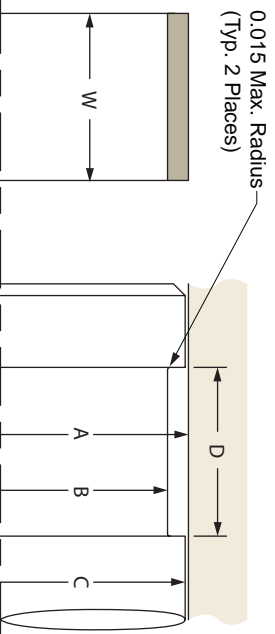

Table 9-13. PDT Profile – Bulk Strip



Gland Dimensions — PDT Profile, Piston (Cut-To-Length)



Please refer to Engineering [Section 2](#), [page 2-8](#) for surface finish and additional hardware considerations.

Table 9-14. PDT Profile — Piston Gland Calculation (Cut-to-Length)

Style (Thickness)	Bore Diameter ^A		Groove Diameter ^B		Piston Diameter ^C		Groove Width ^D
	Range	Tol	Calculation	Tol.	Calculation	Tol.	
^A (.062)	1.000 - 2.000	+002/-.000	Dia. A - .125	+000/-.002	Dia. A - .021	+000/-.002	D = W + .010
	1.500 - 4.875	+002/-.000	Dia. A - .187	+000/-.002	Dia. A - .021	+000/-.002	D = W + .010
^B (.093)	5.000 - 7.750	+004/-.000	Dia. A - .187	+000/-.003	Dia. A - .022	+000/-.003	D = W + .010
	8.000 - 10.000	+006/-.000	Dia. A - .187	+000/-.004	Dia. A - .023	+000/-.004	D = W + .010
^C (.125)	2.000 - 4.875	+002/-.000	Dia. A - .251	+000/-.002	Dia. A - .021	+000/-.002	D = W + .010
	5.000 - 7.750	+004/-.000	Dia. A - .251	+000/-.003	Dia. A - .022	+000/-.003	D = W + .010
	8.000 - 16.000	+006/-.000	Dia. A - .251	+000/-.004	Dia. A - .023	+000/-.004	D = W + .010

For custom groove calculations, see [Appendix C](#).

NOTE: For sizes larger than those shown in the table, please contact your local Parker Seal representative.

Gland Dimensions — PDT Profile, Rod (Cut-To-Length)

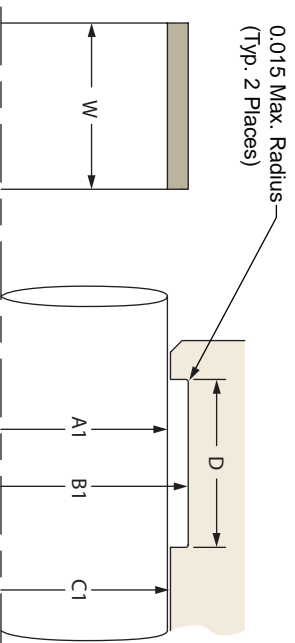

Please refer to Engineering [Section 2](#), [page 2-8](#) for surface finish and additional hardware considerations.

Table 9-15. PDT Profile — Rod Gland Calculation (Cut-to-Length)

Style (Thickness)	Rod Diameter ^{A1}		Groove Diameter ^{B1}		Throat Diameter ^{C1}		Groove Width ^D
	Range	Tol	Calculation	Tol.	Calculation	Tol.	
^D (.062)	0.875 - 2.000	+000/-.002	Dia. A + .125	+002/-.000	Dia. A - .021	+002/-.000	D = W + .010
	1.500 - 5.000	+000/-.002	Dia. A + .187	+002/-.000	Dia. A - .021	+002/-.000	D = W + .010
^E (.093)	1.500 - 3.125	+000/-.002	Dia. A + .187	+002/-.000	Dia. A - .022	+002/-.000	D = W + .010
	3.250 - 4.625	+000/-.002	Dia. A + .251	+002/-.000	Dia. A - .023	+002/-.000	D = W + .010
^F (.125)	4.750 - 7.500	+000/-.004	Dia. A + .251	+002/-.000	Dia. A - .021	+002/-.000	D = W + .010
	7.500 - 10.000	+000/-.006	Dia. A + .251	+003/-.000	Dia. A - .022	+003/-.000	D = W + .010

For custom groove calculations, see [Appendix C](#).

NOTE: For sizes larger than those shown in the table, please contact your local Parker Seal representative.

06/01/2014

PDT Bulk Strip

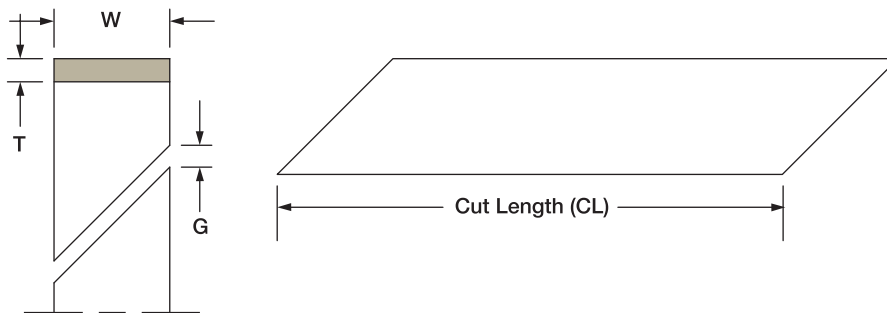

Table 9-16. PDT Bulk Strip Sizes

T Radial Cross-Section	W Width
0.062	0.250
	0.375
	0.500
	0.625
0.093	0.250
	0.375
	0.500
	0.625
0.125	0.250
	0.375
	0.500
	0.625
	0.750
	1.000

Table 9-17. Recommended Cutting Instructions

Rod or Bore Diameter	G Minimum Gap	CL ± Tolerance for Cut Length
0.500 - 1.750	0.075	± .010
1.751 - 3.125	0.140	± .016
3.126 - 4.000	0.175	± .024
4.001 - 5.000	0.230	± .032
5.001 - 6.000	0.260	± .040
6.001 - 7.000	0.320	± .047
7.001 - 8.500	0.380	± .055
8.501 - 10.500	0.480	± .063
10.501 - 13.000	0.620	± .071
13.001 - 16.000	0.750	± .079

NOTE: For sizes larger than those shown in the tables, please contact your local Parker representative.

Formula for Calculating Cut Length, CL

To calculate groove dimensions, use the values for "T" and "G" shown in Tables 9-16 and 9-17 in the following formulas for cut-to-length PDT strip.

For Pistons:

$$CL = [(Bore\ Diameter - T) \times \pi] - G$$

For Rods:

$$CL = [(Rod\ Diameter + T) \times \pi] - G$$



Wear Ring / Bearing PDW Profile

Catalog EPS 5370/USA

PDW Profile, Machined Wear Ring for Rod and Piston

PDW profile wear rings are precision machined PTFE bearings, lathed to exact size and shape. PDW profile wear rings offer precise fitting and easy installation. The wide range of available PTFE blends gives these machined wear rings versatility to accommodate any pneumatic or light-duty hydraulic application requiring low friction and high temperature capabilities.

Technical Data

Standard Material

- 0401 – 40% Bronze-Filled PTFE
- 0307 – 23% Carbon, 2% Graphite-Filled PTFE

Alternate Materials (Composite Fabric-Reinforced Resins)

- 0810 – Standard Polyester-based with PTFE
- 0811 - Graphite-filled Polyester Based
- 0812 - MoS₂-filled Polyester Based
- 0813 - PTFE-Filled Polyester Based

Additional materials available upon request.

Radial Tolerance

+ .000"/-.004"

End Cuts

Butt Cut, Angle Cut (Skive Cut), Step Cut

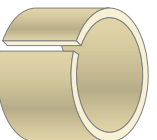
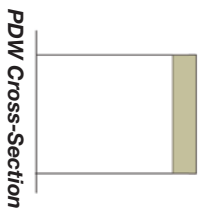

Butt Cut

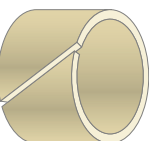

Angle Cut

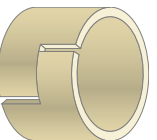

Step Cut

Options

Virtually any width, diameter and cross-section can be produced without assessing a setup charge.

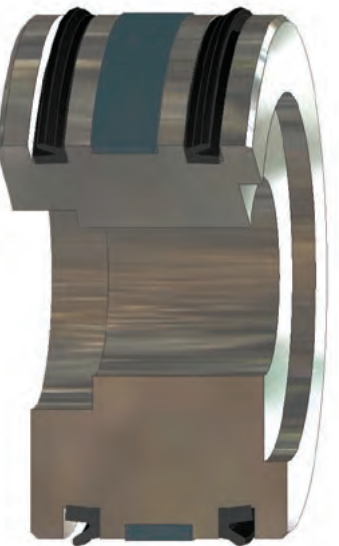

Piston sealing system comprised of PDW machined wear rings and E4 piston u-cups

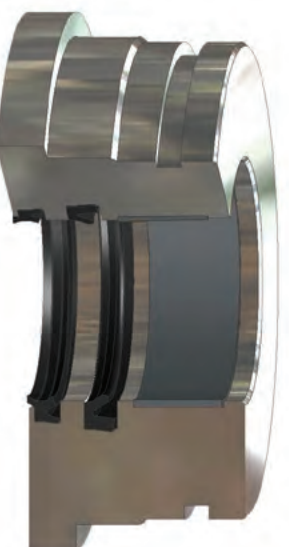

Rod sealing system comprised of PDW machined wear ring, E5 u-cup and 8600 wiper

Part Number Nomenclature – PDW Profile

Table 9-18. PDW Profile

0 4 0 1	PDW	C	0 4 5 0 0	B	0 5 0 0
Material 4 Digit Material Code Example: 0401 = Bronze-filled PTFE (0401, 0307, Others Available)	Profile	Wear Ring Radial Cross-Section Style Examples: A = Piston; 0.062" thick B = Piston; 0.093" thick C = Piston; 0.125" thick D = Rod; 0.062" thick E = Rod; 0.093" thick F = Rod; 0.125" thick	Nominal Diameter (x1000) Example: "C" Style, 04500 = 4.500" Bore (Bore Dia. for Styles A, B, C) (Rod Dia. for Styles D, E, F)	Cut Type Examples: A = Angle Cut B = Butt Cut C = Step Cut	Wear Ring Nominal Width (W) (x1000) Example: 0.500" X 1000 = 0500 (0125 to 2000 or larger)

Gland Dimensions – PDW Profile, Piston

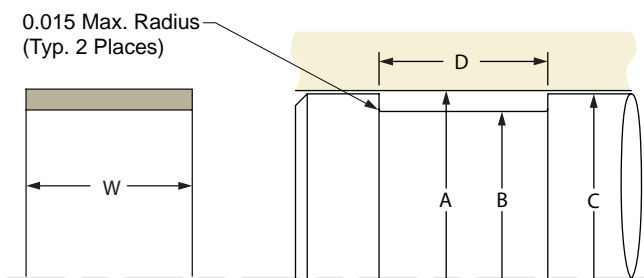

Please refer to Engineering [Section 2](#), [page 2-8](#) for surface finish and additional hardware considerations.

Table 9-19. PDW Profile – Piston Gland Calculation

Style (Thickness)	A Bore Diameter		B Groove Diameter		C Piston Diameter		D Groove Width
	Range	Tol	Calculation	Tol.	Calculation	Tol.	
A (.062)	0.687 - 2.000	+.002/-.000	Dia. A - .125	+.000/-.002	Dia. A - .021	+.000/-.002	D = W + .010
B (.093)	1.500 - 4.999	+.002/-.000	Dia. A - .187	+.000/-.002	Dia. A - .021	+.000/-.002	D = W + .010
	5.000 - 7.999	+.004/-.000	Dia. A - .187	+.000/-.003	Dia. A - .022	+.000/-.003	D = W + .010
C (.125)	8.000 - 10.000	+.006/-.000	Dia. A - .187	+.000/-.004	Dia. A - .023	+.000/-.004	D = W + .010
	2.000 - 4.999	+.002/-.000	Dia. A - .251	+.000/-.002	Dia. A - .021	+.000/-.002	D = W + .010
	5.000 - 7.999	+.004/-.000	Dia. A - .251	+.000/-.003	Dia. A - .022	+.000/-.003	D = W + .010
	8.000 - 16.000	+.006/-.000	Dia. A - .251	+.000/-.004	Dia. A - .023	+.000/-.004	D = W + .010

For custom groove calculations, see [Appendix C](#).

NOTE: For sizes larger than those shown in the table, please contact your local Parker representative.



Gland Dimensions – PDW Profile, Rod

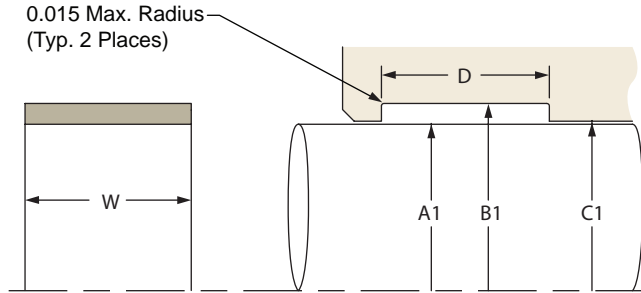

Please refer to Engineering [Section 2, page 2-8](#) for surface finish and additional hardware considerations.

Table 9-20. PDW Profile – Rod Gland Calculation

Style (Thickness)	A1 Rod Diameter		B1 Groove Diameter		C1 Throat Diameter		D Groove Width
	Range	Tol.	Calculation	Tol.	Calculation	Tol.	
D (.062)	0.312 - 2.000	+0.000/-0.002	Dia. A + .125	+0.002/-0.000	Dia. A + .017	+0.002/-0.000	D = W + .010
E (.093)	1.500 - 5.000	+0.000/-0.002	Dia. A + .187	+0.002/-0.000	Dia. A + .021	+0.002/-0.000	D = W + .010
F (.125)	1.500 - 3.125	+0.000/-0.002	Dia. A + .187	+0.002/-0.000	Dia. A + .021	+0.002/-0.000	D = W + .010
	3.250 - 4.625	+0.000/-0.002	Dia. A + .251	+0.002/-0.000	Dia. A + .021	+0.002/-0.000	D = W + .010
	4.750 - 7.500	+0.000/-0.004	Dia. A + .251	+0.003/-0.000	Dia. A + .022	+0.003/-0.000	D = W + .010
	7.500 - 10.000	+0.000/-0.006	Dia. A + .251	+0.004/-0.000	Dia. A + .023	+0.004/-0.000	D = W + .010

For custom groove calculations, see [Appendix C](#).

NOTE: For sizes larger than those shown in the table, please contact your local Parker representative.

Back-up Rings

Contents

Product Offering 10-3
 Decision Tree 10-3
 Product Profiles
 MB 10-4
 8700 10-6
 5100 10-8
 PAB 10-11
 PDB 10-12
 WB 10-14

Back-up Rings

Back-up rings are the most common anti-extrusion devices in dynamic sealing. They provide simple solutions to safely increase system pressure or solve an existing seal extrusion problem. Back-up rings function by positioning a more robust material adjacent to the extrusion gap, taking the seal's place and providing a barrier against high pressures. Back-ups can be used to offset the reduced pressure rating effects of wear rings or to improve seal life at increased pressures. They can also be used to protect seals against pressure spikes, or to ensure seal performance at higher temperatures.

Typical Hydraulic Cylinder

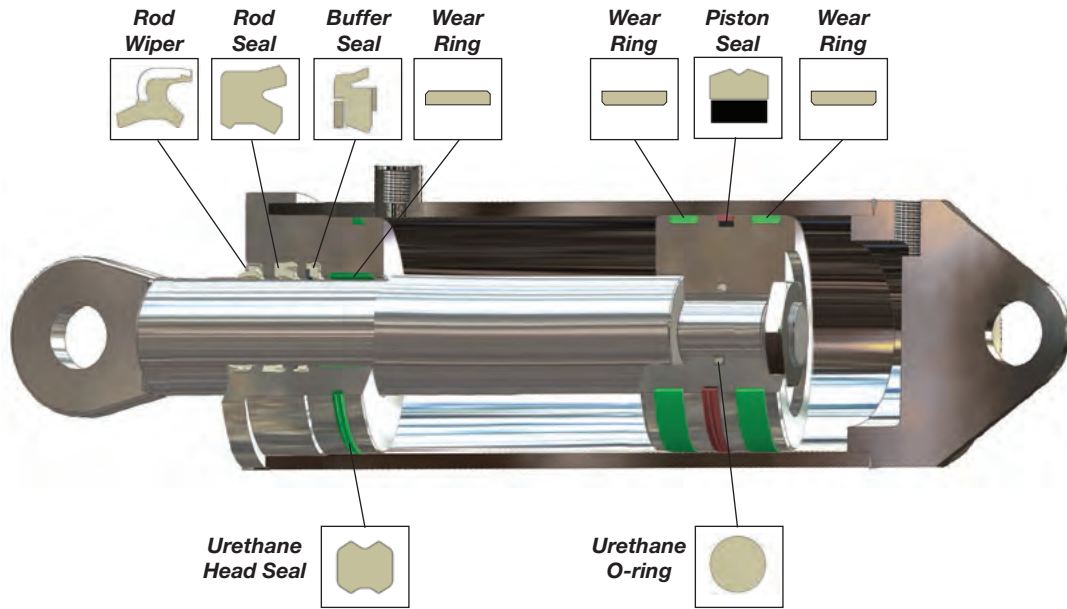

Parker offers a wide range of back-up ring profiles and materials to complement each seal type and to suit every application.

Modular back-up rings disperse pressure from the seal throughout the gland to fill the extrusion gap and protect the seal (see Figure 10-1).

The use of Profile MB can increase a PolyPak® seal's pressure rating to 10,000 psi, while 8700 back-ups provide added extrusion resistance to u-cups with only a minimal increase in gland width.

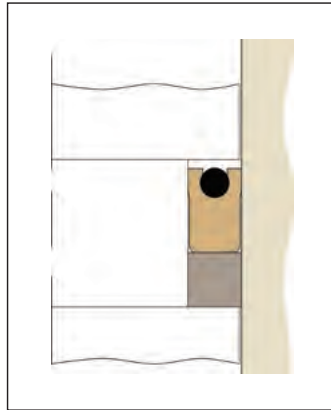

Figure 10-1. Modular Back-up Ring

Positively-actuated back-up rings are actuated both axially and radially into the extrusion gap, guarding the seal against extrusion (see Figures 10-2 and 10-3). For many profiles, positively-actuated back-ups can provide the ultimate extrusion resistance while retaining the seal's original gland dimensions.

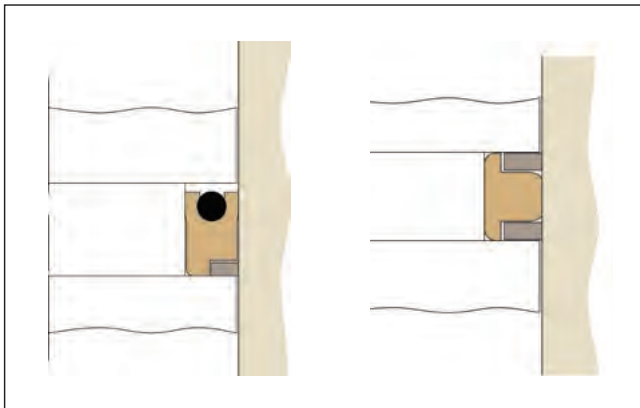

Figure 10-2. Positively-Actuated Back-up Rings

For extreme pressures, a single modular back-up is replaced with dual wedge-shaped back-ups (WB Profile), composed of engineered plastics such as UltraCOMP™ (PEEK).

As pressure increases, the angled back-ups are forced to bridge the clearance gap, eliminating extrusion. This method has been used successfully for custom applications operating at pressures as high as 100,000 psi.

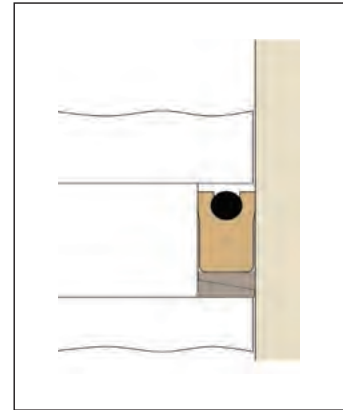

Figure 10-3. Wedged / Angled Back-up Ring

Custom back-up rings. Parker can design custom back-up ring systems utilizing metal or engineered plastics technology and highly advanced geometries. Contact Parker or your authorized distributor for engineering assistance in designing custom back-up configurations.

When to Use Back-up Rings

- System operating pressure exceeds the limitations of the seal's extrusion resistance.
- Pressure spikes in the system exceed normal operating conditions, risking damage to the seal.
- The use of wear rings has increased the extrusion gap, reducing the seal's pressure rating to an unacceptable level.
- The system temperature is high enough to lower the seal's extrusion resistance to an unacceptable level.

Back-up Rings Product Offering

Profiles

Table 10-1: Product Profiles

Series	Description	Application (Duty)				Page	Series	Description	Application (Duty)				Page
		Light	Medium	Heavy	Pneumatic				Light	Medium	Heavy	Pneumatic	
MB	Modular Back-up for PolyPak® & U-cup seals					10-4	PAB	Positively-Activated Back-up					10-11
8700	Low Profile Back-up for PolyPak & U-cup seals					10-6	PDB	PTFE Back-up					10-12
5100	O-ring Groove Back-up					10-8	WB	Wedged Back-ups					10-14

Back-up Rings Decision Tree

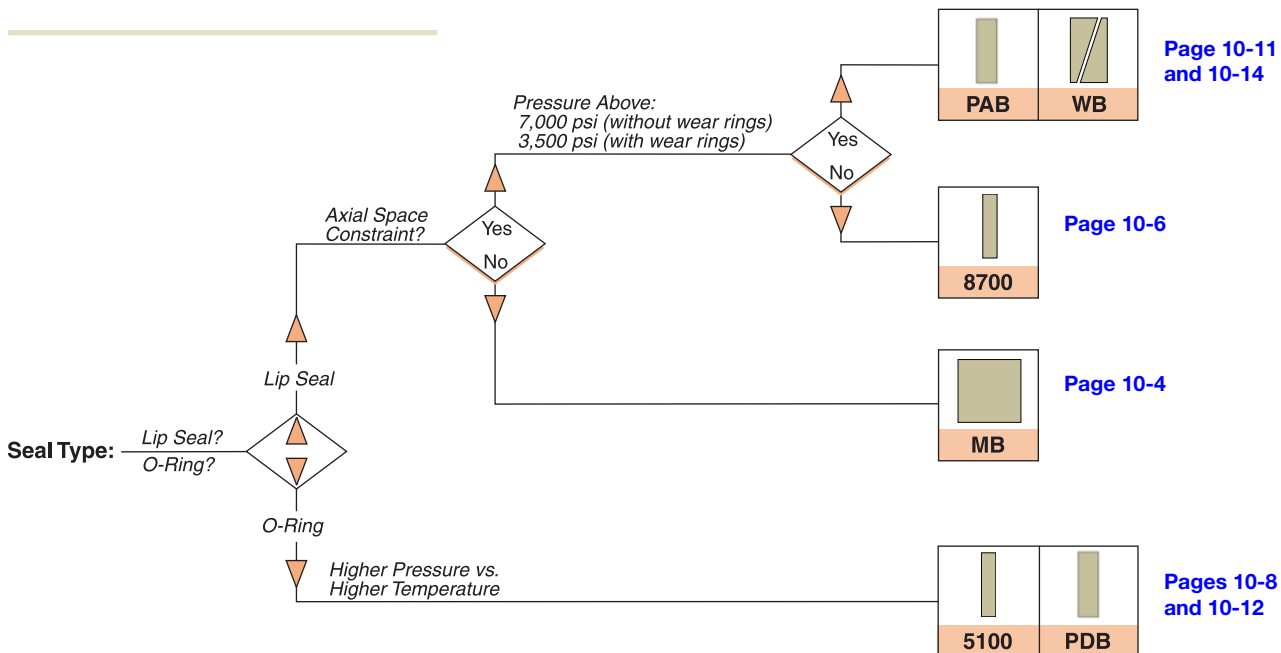

Back-up Ring MB Profile

Catalog EPS 5370/USA



MB Profile, Modular Back-up for PolyPak® and U-cup Seals

Modular back-ups, MB profile, are specifically designed to complement the PolyPak® profiles. To help make the selection and ordering of the correct part number for the MB profile easy and efficient, the part numbering system used is very similar to that of the PolyPak. By formulating high modulus blends of Molythane® (4617) and Polymyte® (4652), Parker has ensured that MB back-ups can be used with either type of base sealing material while maintaining the expected temperature range and fluid compatibility. The robust design ensures pressure ratings up to 10,000 psi are met.

Technical Data

Standard Materials*	Temperature	Max. Pressure Range**
P4617D65	-65°F to +250°F (-54°C to +121°C)	10,000 psi (689 bar)
Z4652D65	-65°F to +275°F (-54°C to +135°C)	10,000 psi (689 bar)

***Alternate Materials:** For applications that may require an alternate material, please contact your local Parker representative.

****** 7,000 psi (482 bar) with tight-tolerance wear rings.
5,000 psi (344 bar) with standard-tolerance wear rings.

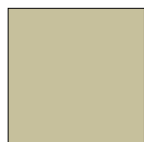

MB Cross-Section

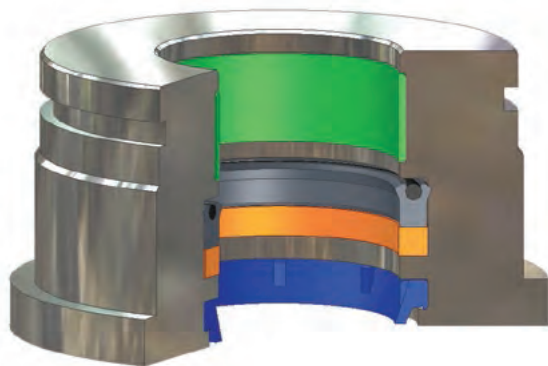

MB installed in Rod Gland

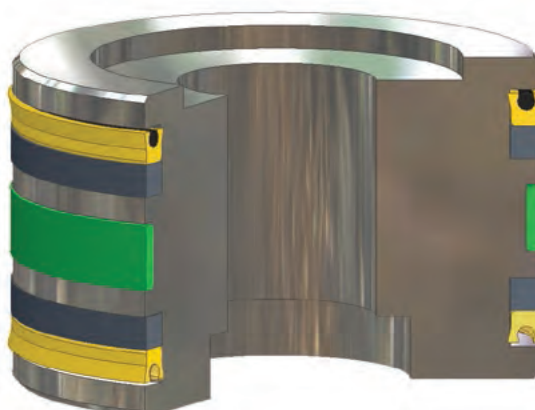

MB installed in Piston Gland

Part Number Nomenclature – MB Profile

Table 10-2. MB Profile – Inch

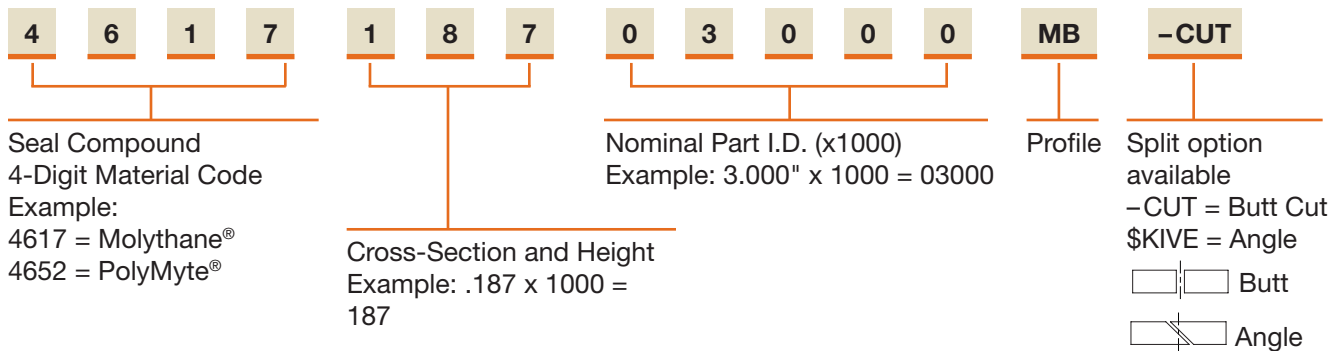

Gland Dimensions – MB Profile

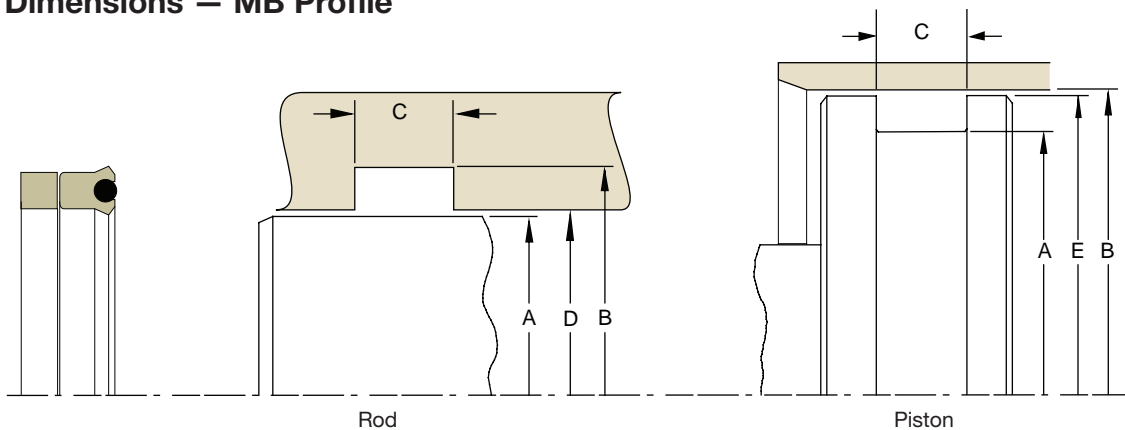

Please refer to Engineering [Section 2, page 2-8](#) for surface finish and additional hardware considerations.

How to Determine the Gland Width when Using Modular Back-up Rings

The MB Profile back-up ring allows you to extend the pressure rating of a seal that fits into the common gland used by such seals as PolyPak®, BS, BT, BD, B3, B7, UP, UR and US profiles. In order to use the MB profile back-up ring, the width of the seal gland must be extended to account for the height of the back-up. Utilizing the gland calculations tables as shown in this catalog, add the value shown in Table 10-3 to the calculated gland width of the seal.

Table 10-3. Added Gland Width Values

Seal Cross Section	Added Gland Width
1/8	0.138
3/16	0.206
1/4	0.275
5/16	0.343
3/8	0.413
7/16	0.481
1/2	0.550
5/8	0.688
3/4	0.825
1	1.100

For non-standard cross sections the added gland width can be determined by multiplying the cross section by (1.1). The tolerance on the extended gland remains the same as it is for the seal gland width, which is usually +.015.

Back-up Ring 8700 Profile

Catalog EPS 5370/USA

8700 Profile, Low Profile Modular Back-up for PolyPak® and U-cup Seals



8700 profile back-up rings provide added extrusion resistance to u-cups and PolyPak® seals with only minimal increase in gland width. The 8700 profile back-up was originally designed to dramatically increase the pressure rating of rubber u-cups in situations where temperature or fluid compatibility prevent the use of urethane seals. As such, 8700 profile back-ups share a part numbering system very similar to our 8400 and 8500 profile rubber u-cups for easy matching of components. Additionally, they are perfect for adding heavy duty pressure capabilities to medium duty urethane sealing systems.

Technical Data

Standard Materials	Temperature	Max. Pressure Range**
Z4651D60	-65°F to +275°F (-54°C to +135°C)	7,000 psi (482 bar)

Alternate Materials: For applications that may require an alternate material, please contact your local Parker representative.

** 4,900 psi (337 bar) with tight-tolerance wear rings.
3,500 psi (241 bar) with standard-tolerance wear rings.



8700 Cross-Section

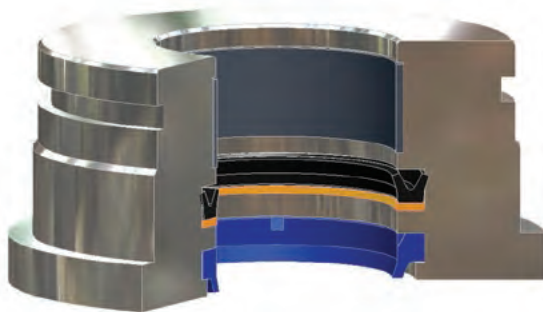

8700 installed in Rod Gland

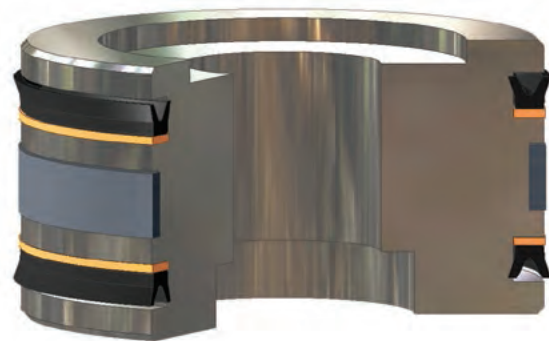

8700 installed in Piston Gland

Part Number Nomenclature — 8700 Profile

Table 10-4. 8700 Profile — Inch

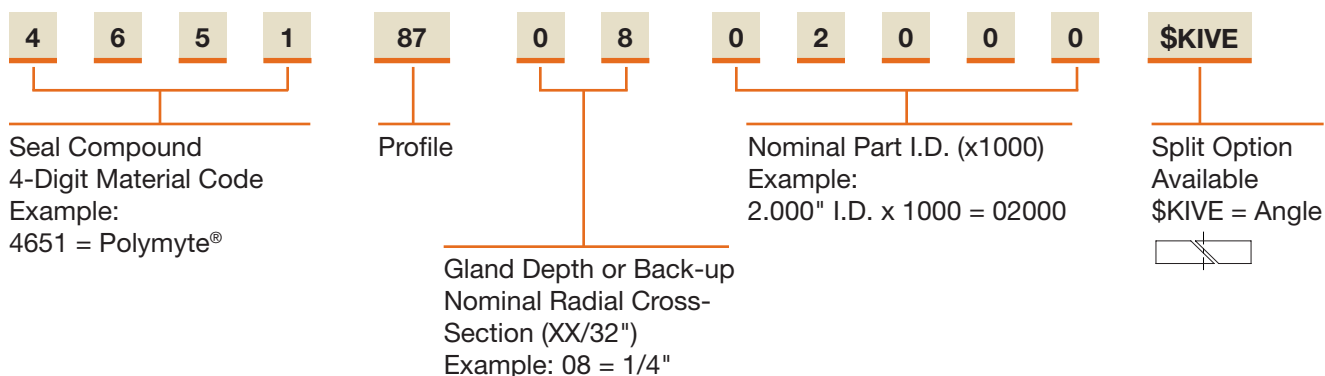

Gland Dimensions — 8700 Profile

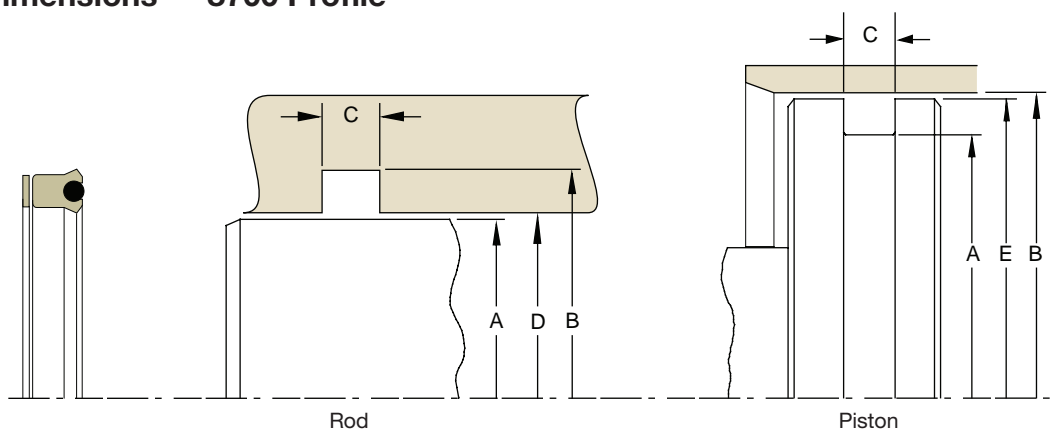

Please refer to Engineering [Section 2, page 2-8](#) for surface finish and additional hardware considerations.

How to Determine the Gland Width when Using 8700 Profile Back-up Rings

The 8700 profile back-up ring allows you to extend the pressure rating of a seal that fits into the common gland used by such seals as PolyPak®, BS, BT, BD, B3, B7, UP, UR and US profiles. In order to use the 8700 profile back-up ring, the width of the seal gland must be extended to account for the height of the back-up ring. Utilizing the gland calculations tables as shown in this catalog, add the value shown in Table 10-5 to the calculated gland width of the seal.

Table 10-5. Added Gland Width Values

Seal Cross Section	Added Gland Width
1/8	0.062
3/16	0.062
1/4	0.062
5/16	0.062
3/8	0.062
7/16	0.062
1/2	0.062
5/8	0.062
3/4	0.062
1	0.062

For non-standard cross sections the added gland width can be determined by adding 0.062 to the cross section. The tolerance on the extended gland remains the same as it is for the seal gland width, which is usually +.015.

Back-up Ring 5100 Profile

Catalog EPS 5370/USA

5100 Profile (5100 Series), O-ring Groove Back-up

Parker 5100 profile back-up rings offer extrusion resistance up to 7,000 psi for dynamic applications and up to 20,000 psi for static applications. They are physically interchangeable with most existing o-ring back-ups. Our easy to identify orange colored 4651 Polymyte® material used with this profile, provides outstanding extrusion resistance when compared to hard nitrile back-ups plus offers extended fluid compatibility. 5100 profile back-ups are designed to meet standard industrial o-ring groove dimensions for single or dual back-up o-ring groove designs and will always install in the proper direction.

Note: For custom tolerances for rod or piston application, please contact your Parker representative.

Technical Data

Standard Materials*	Temperature	Dynamic**	Static	Max. Pressure Range
Z4651D60	-65°F to +275°F (-54°C to +135°C)	7,000 psi (482 bar)	20,000 psi (1,379 bar)	

***Alternate Materials:** For applications that may require an alternate material, please contact your local Parker Seal representative.

** 4,900 psi (337 bar) with tight-tolerance wear rings.
3,500 psi (241 bar) with standard-tolerance wear rings.



5100 Cross-Section

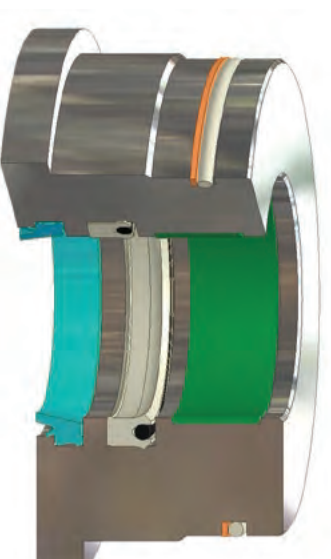

5100 installed in Rod Gland

Part Number Nomenclature – 5100 Profile

Table 10-6. 5100 Profile – Inch



Gland Dimensions – 5100 Profile (Static O-ring Grooves)

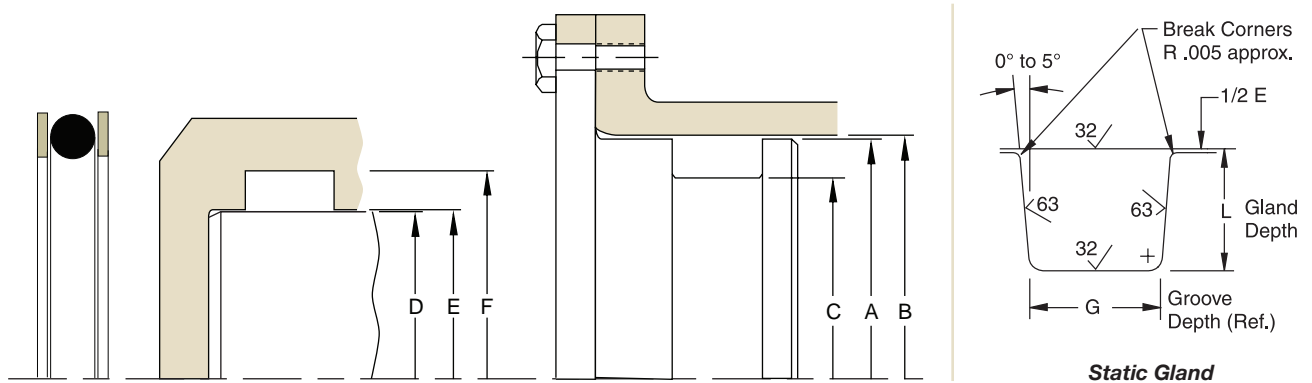

Please refer to Engineering [Section 2, page 2-8](#) for surface finish and additional hardware considerations.

Table 10-7. 5100 Profile – General Gland Dimensions – Static

O-ring 2-Size AS568	Cross Section		Static			E Diametral Clearance (a)	G-Groove Width			R Groove Radius	Max. Eccen- tricity (b)
	Nominal	Actual	L Gland Depth	Squeeze			0 Back-up Ring (G)	1 Back-up Ring (G)	2 Back-up Ring (G)		
				Actual	%						
004 to 050	1/16	0.070 ±0.003	0.050 to 0.052	0.015 to 0.023	22 to 32	0.002 to 0.005	0.093 to 0.098	0.138 to 0.143	0.205 to 0.210	0.005 to 0.015	0.002
102 through 178	3/32	.103 ±0.003	0.081 to 0.083	0.017 to 0.025	17 to 24	0.002 to 0.005	0.140 to 0.145	0.171 to 0.176	0.238 to 0.243	0.005 to 0.015	0.002
201 through 284	1/8	.139 ±0.004	0.111 to 0.113	0.022 to 0.032	16 to 23	0.003 to 0.006	0.187 to 0.192	0.208 to 0.213	0.275 to 0.280	0.010 to 0.025	0.003
309 through 395	3/16	.210 ±0.005	0.170 to 0.173	0.032 to 0.045	15 to 21	0.003 to 0.006	0.281 to 0.286	0.311 to 0.316	0.410 to 0.415	0.020 to 0.035	0.004
425 through 475	1/4	.275 ±0.006	0.226 to 0.229	0.040 to 0.055	15 to 20	0.004 to 0.007	0.375 to 0.380	0.408 to 0.413	0.538 to 0.543	0.020 to 0.035	0.005

(a) Clearance (extrusion gap) must be held to a minimum consistent with design requirements for temperature range variation.

(b) Total indicator reading between groove and adjacent bearing surface.

NOTE: For sizes larger than those shown in the table, please contact your local Parker seal representative.

10

Gland Dimensions – 5100 Profile (Dynamic O-ring Grooves)

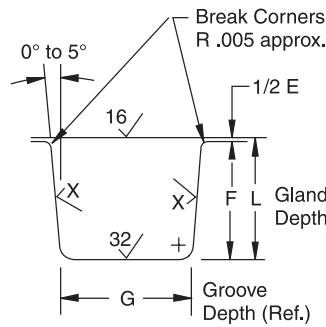
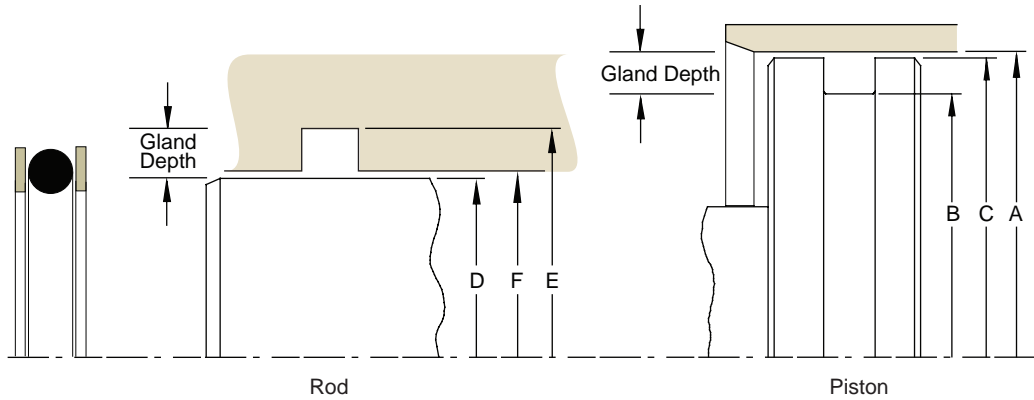

Dynamic Gland

Table 10-8. 5100 Profile – General Gland Dimensions – Dynamic

O-ring 2-Size AS568	Cross Section		Dynamic			E Diametral Clearance (a)	G-Groove Width			R Groove Radius	Max. Eccentricity (b)
	Nominal	Actual	L Gland Depth	Squeeze			0 Back-up Ring (G)	1 Back-up Ring (G)	2 Back-up Ring (G)		
				Actual	%						
004 to 050	1/16	.070 ±.003	.055 to .057	.010 to .018	15 to 25	.002 to .005	.093 to .098	.138 to .143	.205 to .210	.005 to .015	.002
102 through 178	3/32	.103 ±.003	.088 to .090	.01 to .018	10 to 17	.002 to .005	.140 to .145	.171 to .176	.238 to .243	.005 to .015	.002
201 through 284	1/8	.139 ±.004	.121 to .123	.012 to .022	9 to 16	.003 to .006	.187 to .192	.208 to .213	.275 to .280	.010 to .025	.003
309 through 395	3/16	.210 ±.005	.185 to .188	.017 to .030	8 to 14	.003 to .006	.281 to .286	.311 to .316	.410 to .415	.020 to .035	.004
425 through 475	1/4	.275 ±.006	.237 to .240	.029 to .044	11 to 16	.004 to .007	.375 to .380	.408 to .413	.538 to .543	.020 to .035	.005

(a) Clearance (extrusion gap) must be held to a minimum consistent with design requirements for temperature range variation.

(b) Total indicator reading between groove and adjacent bearing surface.

NOTE: For sizes larger than those shown in the table, please contact your local Parker representative.

Back-up Ring PAB Profile



PAB Profile, Positively-Actuated Back-up

While modular back-ups require an increase in groove width to be incorporated into the sealing system, PAB profile back-ups do not change the required axial groove width because they are integrated with the seal. For many profiles, these back-ups can provide the ultimate extrusion resistance while retaining the seal's original groove dimensions. While the most common material used to manufacture positively-actuated back-ups is nylon, it is not uncommon to see applications that require materials such as PEEK or PTFE.

Due to the nature of this product line and the design relationship between the back-up and the seal, parts are sold only as part of an assembly that includes the seal design best suited to the application.

Positively-actuated back-ups can be incorporated into profiles such as the BPP and BD. Tooling may be required.



Positively-Actuated Cross-Section

Technical Data

Standard Materials*	Temperature	Max. Pressure Range**	
Rod			* Alternate Materials: For applications that may require an alternate material, please contact your local Parker representative.
R0 (Virgin PTFE)	-425°F to +450°F (-254°C to +233°C)	5,000 psi (344 bar)	
R1 (4655)	-65°F to +275°F (-54°C to +135°C)	3,000 psi (206 bar)	
R12 (PEEK)	-65°F to +500°F (-54°C to +260°C)	10,000 psi (689 bar)	
Piston			** 7,000 psi (482 bar) with tight-tolerance wear rings. 5,000 psi (344 bar) with standard-tolerance wear rings.
P0 (Virgin PTFE)	-65°F to +250°F (-54°C to +121°C)	5,000 psi (344 bar)	
P1 (4655)	-20°F to +250°F (-29°C to +121°C)	3,000 psi (206 bar)	
P12 (PEEK)	-65°F to +500°F (-54°C to +260°C)	10,000 psi (689 bar)	

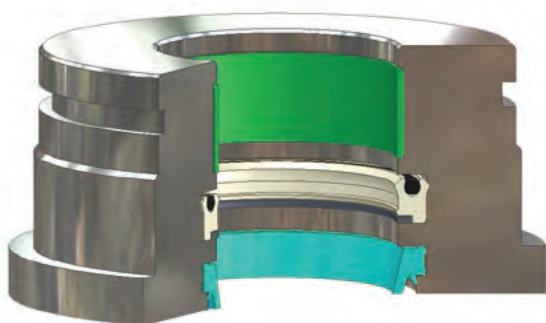

PAB Profile installed in Rod Gland

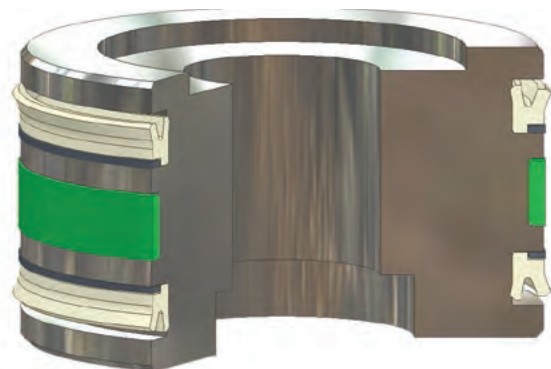

PAB Profile installed in Piston Gland

Back-up Ring PDB Profile

Catalog EPS 5370/USA



PDB Profile, PTFE O-Ring Back-up

PDB profile back-up rings are PTFE anti-extrusion rings. The PDBA and PDBB profiles are designed to retrofit MIL Spec grooves used in commercial applications. PDBA styles are split rings retrofitting MS28774 designs, while PDBB styles are solid rings retrofitting MS27595 designs. Due to the fact that these profiles are designed to commercial grooves, MIL Spec certifications are not available. Although the standard material is virgin PTFE, any of Parker's available PTFE blends can be used.

Technical Data

Standard Materials

0100 Virgin PTFE

Temperature

-425°F to +450°F
(-254°C to +232°C)

Max. Pressure Range

1,500 psi (103 bar) dynamic
4,500 psi (310 bar) static

Alternate Materials: For applications that may require an alternate material, please see [Section 3 \(Table 3-7\)](#) for alternate PTFE materials.



PDB Cross-Section

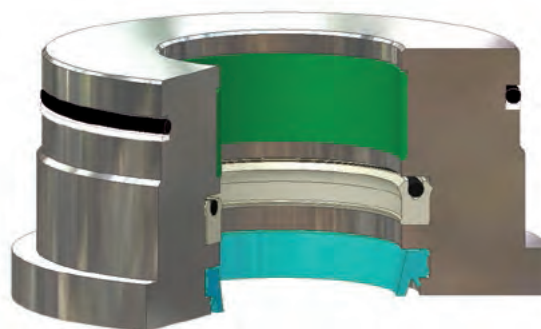

PDB installed in Rod Gland

Part Number Nomenclature — PDBA Profile, Split Ring

Table 10-9. PDBA Profile

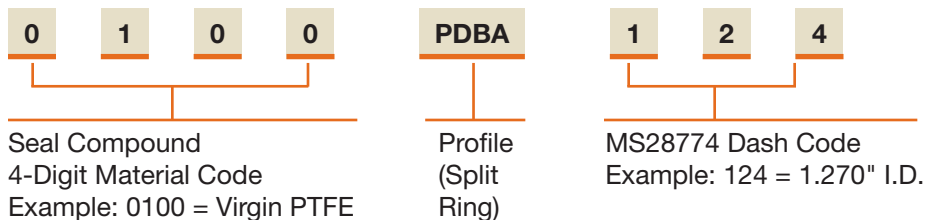

Part Number Nomenclature — PDBB Profile, Solid Ring

Table 10-10. PDBB Profile

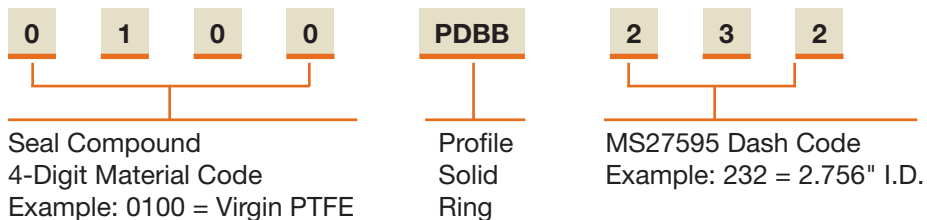

Part Dimensions — PDBA and PDBB Profiles – [See Appendix F.](#)

Back-up Ring WB Profile

Catalog EPS 5370/USA

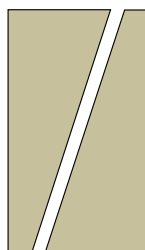

WB Cross-Section

WB Profile, HPHT Back-up

Parker's wedged back-up rings extend seal life by preventing extrusion of elastomeric seals in high pressure, high temperature environments. WB profile back-up rings are custom made-to-order and available in a variety of materials depending upon operating conditions.

Under high system pressure, the elastomer seal applies an axial force on to the wedged back-up set. This axial force allows the wedged halves of the back-up set to slide apart along their common angle and bridge the metal gland clearance gaps; preventing extrusion of the primary sealing elastomer.

Technical Data

Standard Materials*	Temperature	Max. Pressure Range
W4685 Unfilled PEEK	-65°F to +500°F (-54°C to +260°C)	20,000 psi (1,379 bar)
W4686 Glass-filled PEEK	-65°F to +500°F (-54°C to +260°C)	20,000 psi (1,379 bar)
W4738 Carbon, Graphite, PTFE-filled PEEK	-65°F to +500°F (-54°C to +260°C)	15,000 psi (1,034 bar)
W4655 Nylon 6,6 with MoS ₂	-65°F to +275°F (-54°C to +135°C)	10,000 psi (689 bar)
0401 Bronze-filled PTFE	-200°F to +575°F (-129°C to +302°C)	10,000 psi (689 bar)
0307 Carbon, Graphite-filled PTFE	-250°F to +575°F (-157°C to +302°C)	10,000 psi (689 bar)

*Assumes max. radial e-gap of 0.005" (13mm), typical gland dimensions without wear rings.

For assistance in material selection, please call Parker's application engineers.



WB Profile with PolyPak® Seal

Part Number Nomenclature – WB Profile

Table 10-11. WB Profile

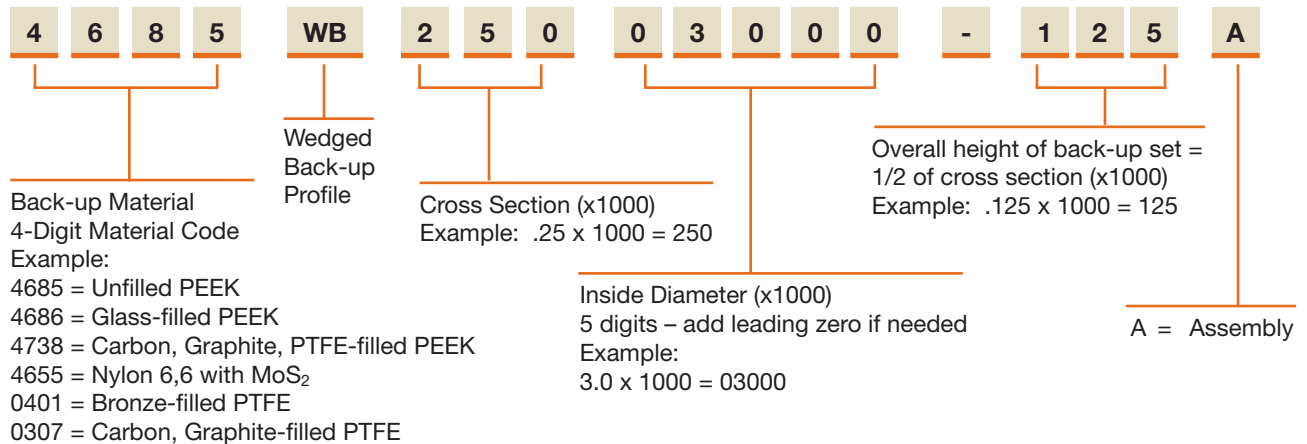

Features and Benefits

Table 10-12.

Feature	Benefit
2 piece back-up with common angle	Common angle allows parts to slide apart to bridge extrusion gap
Split for easy installation	Back-ups are skive cut for easy installation and may be installed upside down for piston or rod extrusion gaps
Can be designed to replace O-ring back-up	Back-ups can be designed for use with U-cup seals, PolyPak® seals and other seal designs for higher pressures
Machined from high performance materials for HPHT environments.	PEEK can be used to 500°F and 20,000 psi. 4655 can be used to 275°F and 10,000 psi. Filled PTFE blends can be used for applications requiring lower friction.
All parts made to order	Parts are machined and can be made for any size combination and quantity

How to Determine the Gland Width when Using WB Profile Back-up Rings

The WB Profile Back-up ring allows you to extend the pressure rating of a seal that fits into the common gland used by such seals as the PolyPak® Profiles. In order to use the WB Back-up ring, the width of the seal gland must be extended to account for the height of the WB Back-up set. Utilizing the gland calculations tables as shown in this catalog, add the value shown in Table 10-13 to the calculated gland width of the seal.

Table 10-13. Added Gland Width Values

Seal Cross Section	Added Gland Width
1/8	0.063
3/16	0.094
1/4	0.125
5/16	0.156
3/8	0.186
7/16	0.219
1/2	0.250
5/8	0.313
3/4	0.375
1	0.500

For non-standard cross sections call Parker’s application engineers for a proposal drawing. The tolerance on the extended gland remains the same as it is for the seal gland width, which is usually +.015.

WB Profile – Engineering
How Wedged Back-ups Work

Wedged back-up rings are used to protect the main sealing elements in high pressure applications. The WB Profile is not a seal, but is used in conjunction with elastomeric seals to bridge the metal gland extrusion gaps and prevent the elastomeric seal from extruding (See Fig 10-4).

As pressure contacts the main seal upstream from the back-up rings, the sealing systems are forced to the point of least resistance which is the extrusion gap (Fig. 10-5 and 10-6). Since the seal is positioned on top of the back-up ring set, as pressure increases, it comes in contact with the back-up set. Pressure acts on the common-angled back-up rings causing them to slide apart. As they do, the respective ID and OD shift to their points of least resistance and close off the extrusion gap — providing zero clearance for the softer elastomer. With the gap eliminated, sealing becomes more effective and longer lasting despite extremely high system pressures.

Double-Acting. Two wedged-back-up ring sets can be used in double-acting applications with one back-up set positioned downstream of each pressure direction (Fig 10-7). This design allows seals to function in static or dynamic applications under high pressure and high temperature conditions. The rigid back-up ring design has little effect on breakout and running friction. Depending upon the material selected, the split design facilitates installation on solid pistons without necessity of auxiliary installation tools.



Fig. 10-4. Seal Extrusion

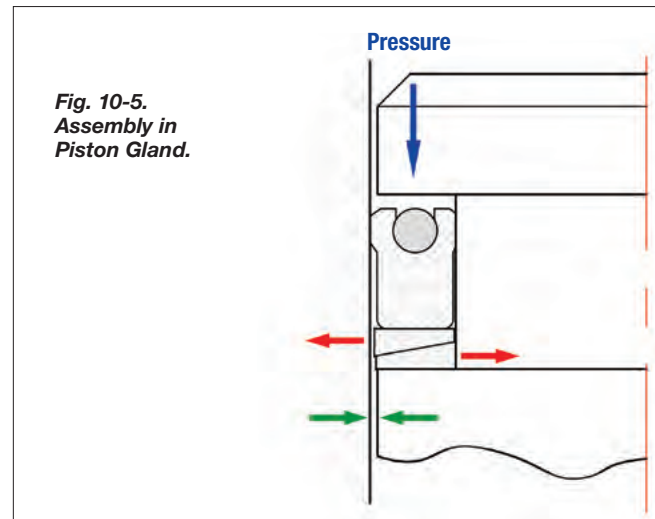

Fig. 10-5.
Assembly in
Piston Gland.

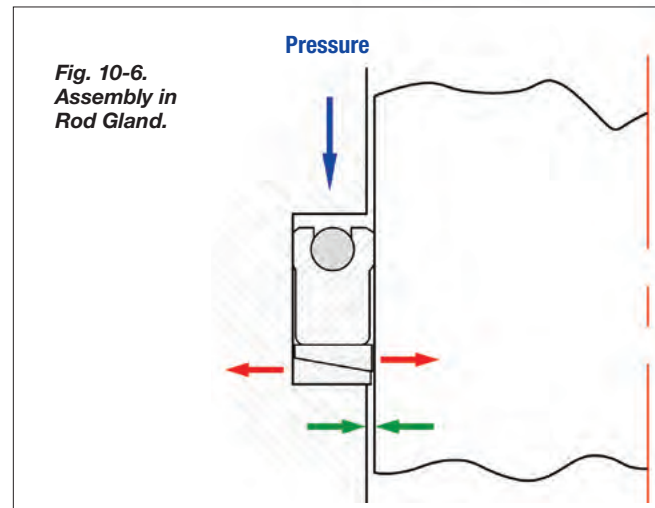

Fig. 10-6.
Assembly in
Rod Gland.

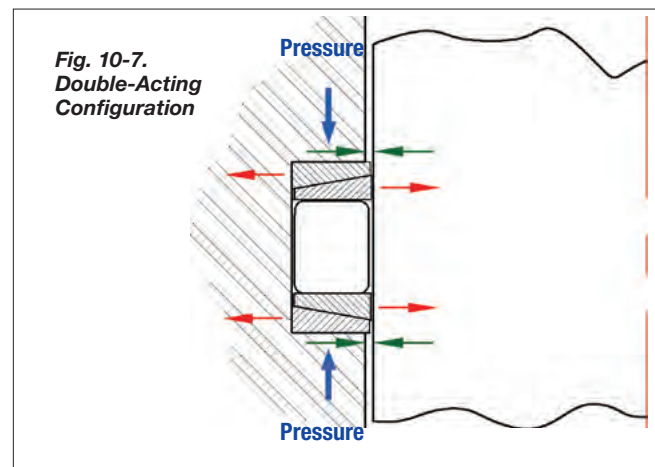

Fig. 10-7.
Double-Acting
Configuration

Legend: Blue arrow shows direction of system pressure. Red arrows show movement of wedged back-ups under pressure to bridge extrusion gap (green arrows).

Urethane O-rings, D-rings & Head Seals

Contents

Product Offering 11-2

Product Profiles

- ◆ 568 Resilon® O-ring 11-3
- ◆ DG Profile, D-Ring 11-9
- HS Profile, Head Seal 11-11

Urethane O-rings, D-rings & Head Seals

Parker offers many materials for fluid power applications that have unique advantages in comparison to traditional materials (see Section 3, Materials). The physical characteristics and mechanical properties of urethane based compounds such as Resilon® 4300 and Resilon® 4301 used in AS568 style o-rings and D-Rings, and P4700 used in urethane head seals, deliver performance advantages over traditional elastomers with low compression set and excellent extrusion resistance.

Urethane O-rings

Parker urethane o-rings offer the material advantages exclusive to the Resilon family of compounds in standard and custom o-ring sizes. High temperature Resilon o-rings eliminate the need for back-ups, simplifying installation and reducing damage due to spiral failure.

Urethane D-rings

Parker's Resilon polyurethane D-ring is a one-piece hydraulic valve sealing solution which delivers longer life and reduced warranty costs over traditional multiple-component seals.

Urethane Head Seals

HS profile static head seals are ideal for replacing o-rings and back-ups in hydraulic cylinder heads. Installation is simplified and failure due to pinching and blow-out is eliminated. The characteristics offered by P4700 urethane provide the performance advantages for this profile.

Typical Hydraulic Cylinder

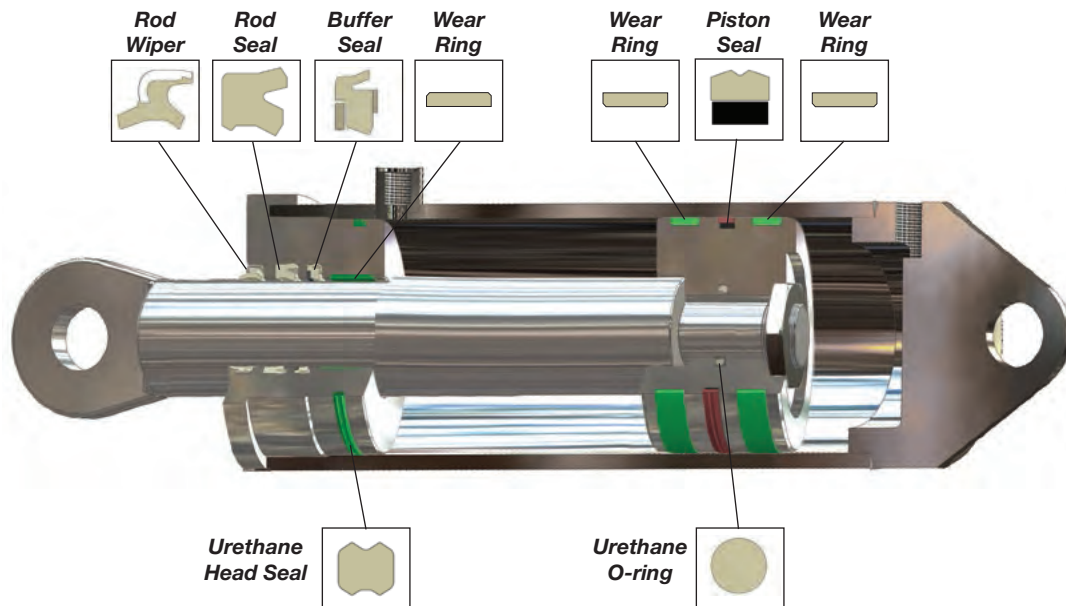















Urethane O-rings, D-Rings & Head Seals

Product Offering

Catalog EPS 5370/USA

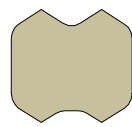
Profiles

Table 11-1: Product Profiles

Series	Description	Application (Duty)				Page
		Light	Medium	Heavy	Pneumatic	
568 	High Performance Urethane O-rings					11-3
DG 	High Performance Urethane D-rings					11-9
HS 	Static Head Seals					11-11

Urethane O-ring 568 Profile

◆ Preferred Profile

Catalog EPS 5370/USA

568 Profile, Resilon® O-ring

Parker is pleased to offer the material advantages of the Resilon® family of urethanes in standard o-ring sizes. The high extrusion resistance of Resilon® 4300 and related compounds eliminates the need for a back-up in many hydraulic applications, thereby simplifying installation and reducing groove width. Resilon's unmatched temperature rating makes it suitable in applications where other urethanes fail. In addition, Resilon® 4301 provides superior water resistance and compression set resistance in water-based fluids. Premium urethane o-rings are much less prone to spiral failure and installation damage compared with rubber o-rings. Dimensions and tolerances of Parker Resilon o-rings match up with AS568B specifications for diameter and cross-section and are used in the same grooves.



568 Cross Section

Technical Data

Standard Materials*

P4300A90

Temperature

-65°F to +275°F
(-54°C to +135°C)

Pressure

5,000 psi (344 bar) dynamic
10,000 psi (688 bar) static

P4301A90

-35°F to +225°F
(-37°C to +107°C)

5,000 psi (344 bar) dynamic
10,000 psi (688 bar) static

***Alternate Materials:** For applications that may require an alternate material, please contact your local Parker seal representative.

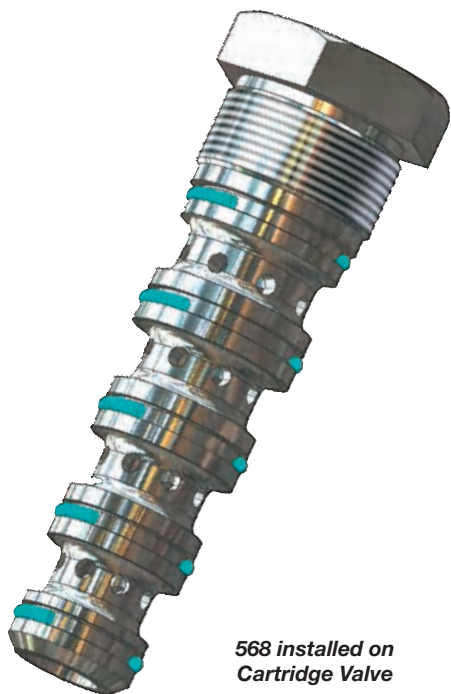

568 installed on
Cartridge Valve

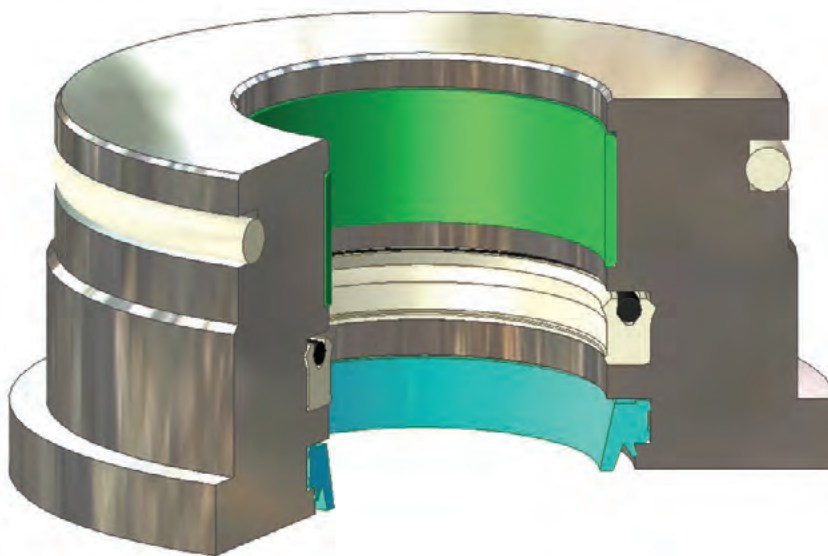

568 installed in Static Head Gland

Part Number Nomenclature – 568 Profile

Table 11-2. 568 Profile – Inch

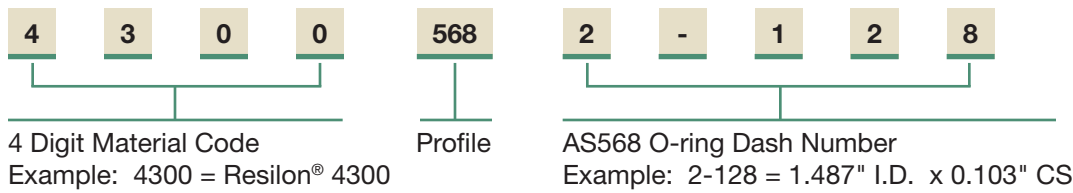

Gland Dimensions – 568 Profile – Dynamic

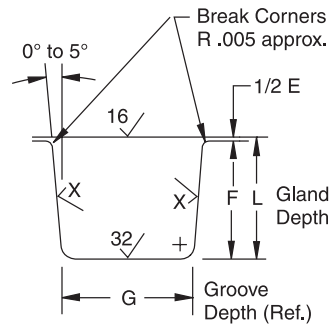
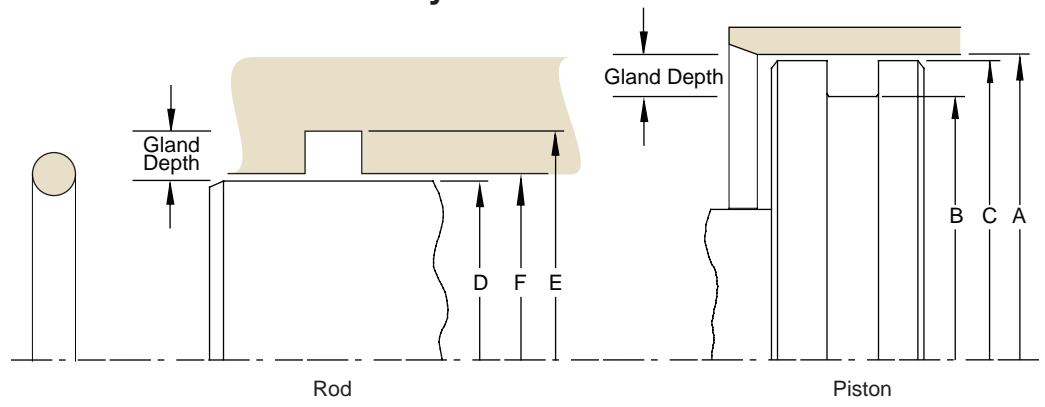

Dynamic Gland

Table 11-3. General O-ring Dimensional Data

O-ring 2-Size AS568	Cross Section		Dynamic			E Diametral Clearance (a)	G-Groove Width			R Groove Radius	Max. Eccentricity (b)
	Nominal	Actual	L Gland Depth	Squeeze			0 Back-up Ring (G)	1 Back-up Ring (G)	2 Back-up Ring (G)		
				Actual	%						
004 to 050	1/16	.070 ±.003	.055 to .057	.010 to .018	15 to 25	.002 to .005	.093 to .098	.138 to .143	.205 to .210	.005 to .015	.002
102 through 178	3/32	.103 ±.003	.088 to .090	.01 to .018	10 to 17	.002 to .005	.140 to .145	.171 to .176	.238 to .243	.005 to .015	.002
201 through 284	1/8	.139 ±.004	.121 to .123	.012 to .022	9 to 16	.003 to .006	.187 to .192	.208 to .213	.275 to .280	.010 to .025	.003
309 through 395	3/16	.210 ±.005	.185 to .188	.017 to .030	8 to 14	.003 to .006	.281 to .286	.311 to .316	.410 to .415	.020 to .035	.004
425 through 475	1/4	.275 ±.006	.237 to .240	.029 to .044	11 to 16	.004 to .007	.375 to .380	.408 to .413	.538 to .543	.020 to .035	.005

(a) Clearance (extrusion gap) must be held to a minimum consistent with design requirements for temperature range variation.

(b) Total indicator reading between groove and adjacent bearing surface.

NOTE: For sizes larger than those shown in the table, please contact your local Parker seal representative.

06/01/2014

Table 11-4. 568 Dynamic O-ring Gland Dimensions, Parker Standard Sizes

O-ring 2-Size AS568	Seal Dimensions			Hardware Dimensions						Part Number			
	Inside Dia.	±	Width ±	Mean O.D. (Ref)	Piston			Rod					
					A Bore Dia.	B Groove Dia.	C Piston Dia.	D Rod Dia.	E Groove Dia.		F Throat Dia.		
006	0.114	0.005	0.070	0.003	0.254	0.249	0.139	0.247	0.124	0.234	0.126	0.126	43005682-006
007	0.145	0.005	0.070	0.003	0.285	0.280	0.170	0.278	0.155	0.265	0.157	0.157	43005682-007
008	0.176	0.005	0.070	0.003	0.316	0.311	0.201	0.309	0.186	0.296	0.188	0.188	43005682-008
009	0.208	0.005	0.070	0.003	0.348	0.343	0.233	0.341	0.218	0.328	0.220	0.220	43005682-009
010	0.239	0.005	0.070	0.003	0.379	0.374	0.264	0.372	0.249	0.359	0.251	0.251	43005682-010
011	0.301	0.005	0.070	0.003	0.441	0.436	0.326	0.434	0.311	0.421	0.313	0.313	43005682-011
012	0.364	0.005	0.070	0.003	0.504	0.499	0.389	0.497	0.374	0.484	0.376	0.376	43005682-012
104	0.112	0.005	0.103	0.003	0.318	0.312	0.136	0.310	0.124	0.300	0.126	0.126	43005682-104
107	0.206	0.005	0.103	0.003	0.412	0.406	0.230	0.404	0.218	0.394	0.220	0.220	43005682-107
110	0.362	0.005	0.103	0.003	0.568	0.562	0.386	0.560	0.374	0.550	0.376	0.376	43005682-110
111	0.424	0.005	0.103	0.003	0.630	0.624	0.448	0.622	0.436	0.612	0.438	0.438	43005682-111
112	0.487	0.005	0.103	0.003	0.693	0.687	0.511	0.685	0.499	0.675	0.501	0.501	43005682-112
113	0.549	0.007	0.103	0.003	0.755	0.749	0.573	0.747	0.561	0.737	0.563	0.563	43005682-113
114	0.612	0.009	0.103	0.003	0.818	0.812	0.636	0.810	0.624	0.800	0.626	0.626	43005682-114
115	0.674	0.009	0.103	0.003	0.880	0.874	0.698	0.872	0.686	0.862	0.688	0.688	43005682-115
116	0.737	0.009	0.103	0.003	0.943	0.937	0.761	0.935	0.749	0.925	0.751	0.751	43005682-116
206	0.484	0.005	0.139	0.004	0.762	0.750	0.508	0.747	0.498	0.740	0.501	0.501	43005682-206
208	0.609	0.009	0.139	0.004	0.887	0.875	0.633	0.872	0.623	0.865	0.626	0.626	43005682-208
210	0.734	0.010	0.139	0.004	1.012	1.000	0.758	0.997	0.748	0.990	0.751	0.751	43005682-210
211	0.796	0.010	0.139	0.004	1.074	1.062	0.820	1.059	0.810	1.052	0.813	0.813	43005682-211
212	0.859	0.010	0.139	0.004	1.137	1.125	0.883	1.122	0.873	1.115	0.876	0.876	43005682-212
214	0.984	0.010	0.139	0.004	1.262	1.250	1.008	1.247	0.998	1.240	1.001	1.001	43005682-214
216	1.109	0.012	0.139	0.004	1.387	1.375	1.133	1.372	1.123	1.365	1.126	1.126	43005682-216
217	1.171	0.012	0.139	0.004	1.449	1.437	1.195	1.434	1.185	1.427	1.188	1.188	43005682-217
218	1.234	0.012	0.139	0.004	1.512	1.500	1.258	1.497	1.248	1.490	1.251	1.251	43005682-218
219	1.296	0.012	0.139	0.004	1.574	1.562	1.320	1.559	1.310	1.552	1.313	1.313	43005682-219

Those Piston O.D.'s shown in shaded area may over stretch the O-ring. If so, select a material with greater elongation or use a two-piece piston.

NOTE: For sizes larger than those shown in the table, please contact your local Parker seal representative.

Gland Dimensions – 568 Profile – Static

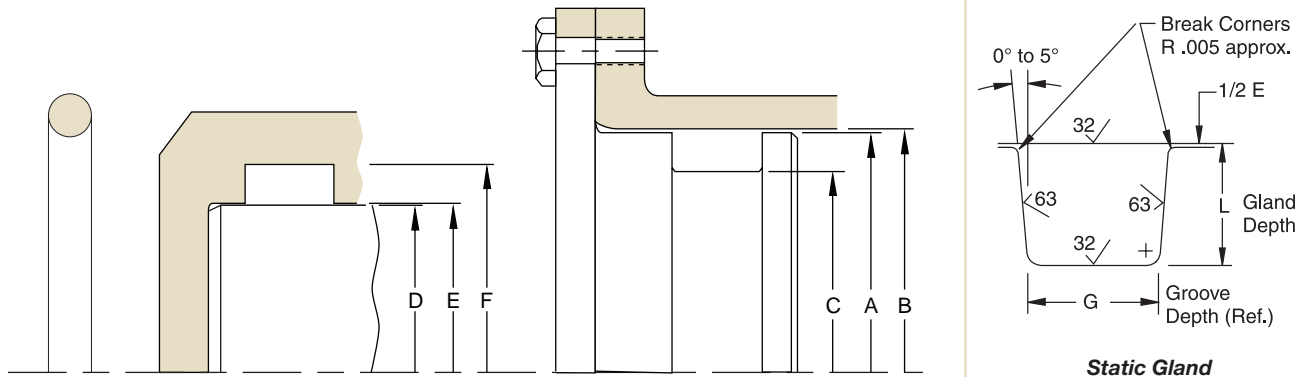

Please refer to [Engineering Section 2, page 2-8](#) for surface finish and additional hardware considerations.

Table 11-5. General O-ring Dimensional Data

O-ring 2-Size AS568	Cross Section		Static			E Diametral Clearance (a)	G-Groove Width			R Groove Radius	Max. Eccentricity (b)
	Nominal	Actual	L Gland Depth	Squeeze			0 Back-up Ring (G)	1 Back-up Ring (G)	2 Back-up Ring (G)		
				Actual	%						
004 to 050	1/16	0.070 ±0.003	0.050 to 0.052	0.015 to 0.023	22 to 32	0.002 to 0.005	0.093 to 0.098	0.138 to 0.143	0.205 to 0.210	0.005 to 0.015	0.002
102 through 178	3/32	.103 ±0.003	0.081 to 0.083	0.017 to 0.025	17 to 24	0.002 to 0.005	0.140 to 0.145	0.171 to 0.176	0.238 to 0.243	0.005 to 0.015	0.002
201 through 284	1/8	.139 ±0.004	0.111 to 0.113	0.022 to 0.032	16 to 23	0.003 to 0.006	0.187 to 0.192	0.208 to 0.213	0.275 to 0.280	0.010 to 0.025	0.003
309 through 395	3/16	.210 ±0.005	0.170 to 0.173	0.032 to 0.045	15 to 21	0.003 to 0.006	0.281 to 0.286	0.311 to 0.316	0.410 to 0.415	0.020 to 0.035	0.004
425 through 475	1/4	.275 ±0.006	0.226 to 0.229	0.040 to 0.055	15 to 20	0.004 to 0.007	0.375 to 0.380	0.408 to 0.413	0.538 to 0.543	0.020 to 0.035	0.005

(a) Clearance (extrusion gap) must be held to a minimum consistent with design requirements for temperature range variation.

(b) Total indicator reading between groove and adjacent bearing surface.

NOTE: For sizes larger than those shown in the table, please contact your local Parker seal representative.

Table 11-6. 568 Static O-ring Gland Dimensions, ♦Parker Standard Sizes

O-ring 2-Size AS568	Seal Dimensions			Piston			Rod			Part Number	
	Inside Dia.	±	Width ±	Mean O.D. (Ref)	A Piston Dia.	B Bore Dia.	C Groove Dia.	D Rod Dia.	E Throat Dia.		F Groove Dia.
005	0.101	0.005	0.070	0.003	0.241	0.235	0.137	0.112	0.114	0.212	43005682-005
006	0.114	0.005	0.070	0.003	0.254	0.248	0.150	0.125	0.127	0.225	43005682-006
007	0.145	0.005	0.070	0.003	0.285	0.279	0.181	0.156	0.158	0.256	43005682-007
008	0.176	0.005	0.070	0.003	0.316	0.310	0.212	0.187	0.189	0.287	43005682-008
009	0.208	0.005	0.070	0.003	0.348	0.341	0.243	0.218	0.220	0.318	43005682-009
010	0.239	0.005	0.070	0.003	0.379	0.373	0.275	0.250	0.252	0.350	43005682-010
011	0.301	0.005	0.070	0.003	0.441	0.435	0.337	0.312	0.314	0.412	43005682-011
012	0.364	0.005	0.070	0.003	0.504	0.498	0.400	0.375	0.377	0.475	43005682-012
013	0.426	0.005	0.070	0.003	0.566	0.560	0.462	0.437	0.439	0.537	43005682-013
014	0.489	0.005	0.070	0.003	0.629	0.623	0.525	0.500	0.502	0.600	43005682-014
015	0.551	0.007	0.070	0.003	0.691	0.685	0.587	0.562	0.564	0.662	43005682-015
016	0.614	0.009	0.070	0.003	0.754	0.748	0.650	0.625	0.627	0.725	43005682-016
017	0.676	0.009	0.070	0.003	0.816	0.810	0.712	0.687	0.689	0.787	43005682-017
018	0.739	0.009	0.070	0.003	0.879	0.873	0.775	0.750	0.752	0.850	43005682-018
019	0.801	0.009	0.070	0.003	0.941	0.935	0.837	0.812	0.814	0.912	43005682-019
020	0.864	0.009	0.070	0.003	1.004	0.998	0.900	0.875	0.877	0.975	43005682-020
021	0.926	0.009	0.070	0.003	1.066	1.060	0.962	0.937	0.939	1.037	43005682-021
022	0.989	0.010	0.070	0.003	1.129	1.123	1.025	1.000	1.002	1.100	43005682-022
023	1.051	0.010	0.070	0.003	1.191	1.185	1.087	1.062	1.064	1.162	43005682-023
024	1.114	0.010	0.070	0.003	1.254	1.248	1.150	1.125	1.127	1.225	43005682-024
026	1.239	0.011	0.070	0.003	1.379	1.373	1.275	1.250	1.252	1.350	43005682-026
027	1.301	0.011	0.070	0.003	1.441	1.435	1.337	1.312	1.314	1.412	43005682-027
028	1.364	0.013	0.070	0.003	1.504	1.498	1.400	1.375	1.377	1.475	43005682-028
029	1.489	0.013	0.070	0.003	1.629	1.623	1.525	1.500	1.502	1.600	43005682-029
030	1.614	0.013	0.070	0.003	1.754	1.748	1.650	1.625	1.627	1.725	43005682-030
031	1.739	0.015	0.070	0.003	1.879	1.873	1.775	1.750	1.752	1.850	43005682-031
104	0.112	0.005	0.103	0.003	0.318	0.308	0.148	0.125	0.127	0.287	43005682-104
107	0.206	0.005	0.103	0.003	0.412	0.403	0.243	0.219	0.221	0.381	43005682-107
109	0.299	0.005	0.103	0.003	0.505	0.498	0.338	0.312	0.314	0.474	43005682-109
110	0.362	0.005	0.103	0.003	0.568	0.560	0.400	0.375	0.377	0.537	43005682-110
111	0.424	0.005	0.103	0.003	0.630	0.623	0.463	0.437	0.439	0.599	43005682-111
112	0.487	0.005	0.103	0.003	0.693	0.685	0.525	0.500	0.502	0.662	43005682-112
113	0.549	0.007	0.103	0.003	0.755	0.748	0.588	0.562	0.564	0.724	43005682-113
114	0.612	0.009	0.103	0.003	0.818	0.810	0.650	0.625	0.627	0.787	43005682-114
115	0.674	0.009	0.103	0.003	0.880	0.873	0.713	0.687	0.689	0.849	43005682-115
116	0.737	0.009	0.103	0.003	0.943	0.935	0.775	0.750	0.752	0.912	43005682-116
117	0.799	0.010	0.103	0.003	1.005	0.998	0.838	0.812	0.814	0.974	43005682-117

Those Piston O.D.'s shown in shaded area may over stretch the o-ring. If so, select a material with greater elongation or use a two-piece piston.

Table 11-6. 568 Static O-ring Gland Dimensions, ♦Parker Standard Sizes (cont'd)

O-ring 2-Size AS568	Seal Dimensions					Piston			Rod			Part Number
	Inside Dia.	±	Width	±	Mean O.D. (Ref)	A	B	C	D	E	F	
						Piston Dia.	Bore Dia.	Groove Dia.	Rod Dia.	Throat Dia.	Groove Dia.	
						+0.00/ -0.01	+0.02/ -0.00	+0.00/ -0.02	+0.00/ -0.02	+0.01/ -0.00	+0.02/ -0.00	
118	0.862	0.010	0.103	0.003	1.068	1.060	1.062	0.900	0.875	0.877	1.037	43005682-118
119	0.924	0.010	0.103	0.003	1.130	1.123	1.125	0.963	0.937	0.939	1.099	43005682-119
120	0.987	0.010	0.103	0.003	1.193	1.185	1.187	1.025	1.000	1.002	1.162	43005682-120
121	1.049	0.010	0.103	0.003	1.255	1.248	1.250	1.088	1.062	1.064	1.224	43005682-121
122	1.112	0.010	0.103	0.003	1.318	1.310	1.312	1.150	1.125	1.127	1.287	43005682-122
123	1.174	0.012	0.103	0.003	1.380	1.373	1.375	1.213	1.187	1.189	1.349	43005682-123
124	1.237	0.012	0.103	0.003	1.443	1.435	1.437	1.275	1.250	1.252	1.412	43005682-124
125	1.299	0.012	0.103	0.003	1.505	1.498	1.500	1.338	1.312	1.314	1.474	43005682-125
126	1.362	0.012	0.103	0.003	1.568	1.560	1.562	1.400	1.375	1.377	1.537	43005682-126
127	1.424	0.012	0.103	0.003	1.630	1.623	1.625	1.463	1.437	1.439	1.599	43005682-127
128	1.487	0.012	0.103	0.003	1.693	1.685	1.687	1.525	1.500	1.502	1.662	43005682-128
129	1.549	0.015	0.103	0.003	1.755	1.748	1.750	1.588	1.562	1.564	1.724	43005682-129
130	1.612	0.015	0.103	0.003	1.818	1.810	1.812	1.650	1.625	1.627	1.787	43005682-130
131	1.674	0.015	0.103	0.003	1.880	1.873	1.875	1.713	1.687	1.689	1.849	43005682-131
132	1.737	0.015	0.103	0.003	1.943	1.935	1.937	1.775	1.750	1.752	1.912	43005682-132
133	1.799	0.015	0.103	0.003	2.005	1.998	2.000	1.838	1.812	1.814	1.974	43005682-133
134	1.862	0.015	0.103	0.003	2.068	2.060	2.062	1.900	1.875	1.877	2.037	43005682-134
135	1.925	0.017	0.103	0.003	2.131	2.123	2.125	1.963	1.997	1.939	2.099	43005682-135
136	1.987	0.017	0.103	0.003	2.193	2.185	2.187	2.025	2.000	2.002	2.162	43005682-136
140	2.237	0.017	0.103	0.003	2.443	2.435	2.437	2.275	2.250	2.252	2.412	43005682-140
143	2.425	0.020	0.103	0.003	2.631	2.623	2.625	2.463	2.437	2.439	2.599	43005682-143
144	2.487	0.020	0.103	0.003	2.693	2.685	2.687	2.525	2.500	2.502	2.662	43005682-144
150	2.862	0.022	0.103	0.003	3.068	3.060	3.062	2.900	2.875	2.877	3.037	43005682-150
154	3.737	0.028	0.103	0.003	3.943	3.935	3.937	3.775	3.750	3.752	3.912	43005682-154
155	3.987	0.028	0.103	0.003	4.193	4.185	4.187	4.025	4.000	4.002	4.162	43005682-155
156	4.237	0.030	0.103	0.003	4.443	4.435	4.437	4.275	4.250	4.252	4.412	43005682-156
206	0.484	0.005	0.139	0.004	0.762	0.747	0.750	0.528	0.500	0.503	0.722	43005682-206
208	0.609	0.009	0.139	0.004	0.887	0.872	0.875	0.653	0.625	0.628	0.847	43005682-208
210	0.734	0.010	0.139	0.004	1.012	0.997	1.000	0.778	0.750	0.753	0.972	43005682-210
211	0.796	0.010	0.139	0.004	1.074	1.059	1.062	0.840	0.812	0.815	1.034	43005682-211
212	0.859	0.010	0.139	0.004	1.137	1.122	1.125	0.903	0.875	0.878	1.097	43005682-212
214	0.984	0.010	0.139	0.004	1.262	1.247	1.250	1.028	1.000	1.003	1.222	43005682-214
216	1.109	0.012	0.139	0.004	1.387	1.372	1.375	1.153	1.125	1.128	1.347	43005682-216
217	1.171	0.012	0.139	0.004	1.449	1.434	1.437	1.215	1.187	1.190	1.409	43005682-217
218	1.234	0.012	0.139	0.004	1.512	1.497	1.500	1.278	1.250	1.253	1.472	43005682-218
219	1.296	0.012	0.139	0.004	1.574	1.559	1.562	1.340	1.312	1.315	1.534	43005682-219

Those Piston O.D.'s shown in shaded area may over stretch the o-ring. If so, select a material with greater elongation or use a two-piece piston.

Urethane D-ring DG Profile

◆ Preferred Profile

Catalog EPS 5370/USA



DG Profile, Urethane D-Ring

Parker's DG profile urethane D-ring is a problem solver featuring a variety of design advantages. The molded "D" shape which is higher in the middle and lower on the ends, provides sealing in critical areas while reducing the chance of a seal being cut during installation. Its sealing lip contact footprint is minimized, thus reducing the amount of friction between seal and bore while providing expected sealing performance. The "D" shape is symmetrical so there is no performance degradation as the valve cycles in the reverse direction nor concern of backward installation of the seal. The design also incorporates "pressure pedestals" to eliminate the potential for "blow-by," common in reverse cycling.



DG Profile Cross Section

Technical Data

Standard Materials*

P4300A90

P4301A90

Temperature

-65°F to +275°F
(-54°C to +135°C)

-35°F to +225°F
(-37°C to +107°C)

Pressure

5,000 psi (344 bar) dynamic

10,000 psi (688 bar) static

5,000 psi (344 bar) dynamic

10,000 psi (688 bar) static

***Alternate Materials:** For applications that may require an alternate material, please contact your local Parker seal representative.



DG installed in Gland

Part Number Nomenclature – DG Profile

Table 11-7. DG Profile

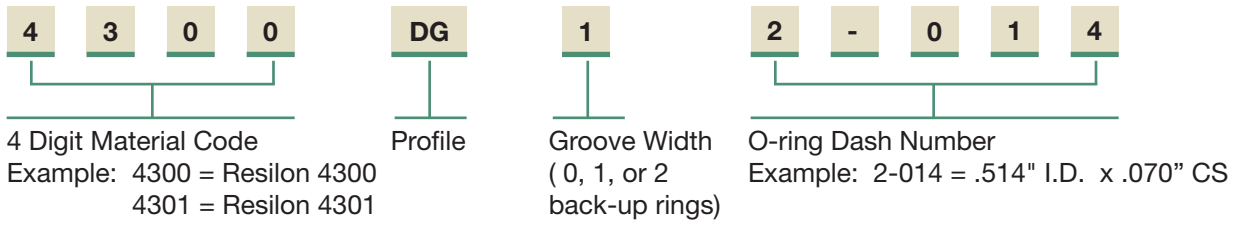

Gland Dimensions – DG Profile

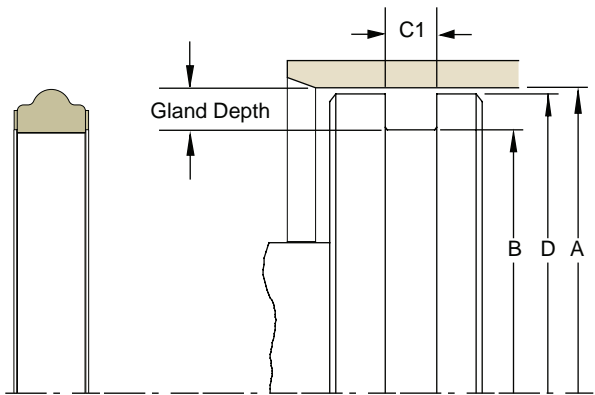

Gland Dimensions – DG Profile

Table 11-8. DG Profile – Piston Gland Dimensions, ♦Parker Standard Sizes

O-ring 2-Size AS568A-	Gland Dimensions				Part Number
	A Bore Diameter	B Groove Diameter	C1 Groove Width One Back-up	D Piston Diameter	
	.002/ -.000	+.000/ -.002	+.005/ -.000	+.000/ -.001	
010	0.374	0.264	0.138	0.372	4300DG12-010
011	0.436	0.326	0.138	0.434	4300DG12-011
012	0.499	0.389	0.138	0.497	4300DG12-012
013	0.561	0.451	0.138	0.559	4300DG12-013
014	0.624	0.514	0.138	0.622	4300DG12-014
015	0.686	0.576	0.138	0.684	4300DG12-015
016	0.749	0.639	0.138	0.747	4300DG12-016
017	0.811	0.701	0.138	0.809	4300DG12-017
018	0.874	0.764	0.138	0.872	4300DG12-018
019	0.936	0.826	0.138	0.934	4300DG12-019
020	0.999	0.889	0.138	0.997	4300DG12-020

Urethane Head Seal

HS Profile

Catalog EPS 5370/USA

HS Profile, Static Head Seal

As mobile equipment OEM's continue to consider warranty costs, one area of focus has been a review of down time related to cylinder head glands. Two of the most common seal failures on cylinder heads are o-ring back-up blow-out and pinched back-ups. Both failures are common in systems with high eccentricities or large extrusion gaps. To address these situations and to reduce down time HS profile static head seals are specified to replace the industry-standard o-ring and back-up. Incorporating high performance plastics with a stable, symmetrical geometry dramatically reduces the risks of installation damage and back-up blow-out. Both problems are eliminated with the HS profile's one piece urethane design offering improved fit and a stable geometry.

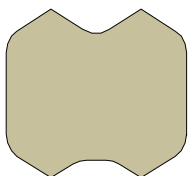

HS Cross Section

Technical Data

Standard Materials*
P4700A90

Temperature
-65°F to +200°F
(-54°C to +93°C)

Pressure
10,000 psi (688 bar) static

***Alternate Materials:** For applications that may require an alternate material, please contact your local Parker seal representative.

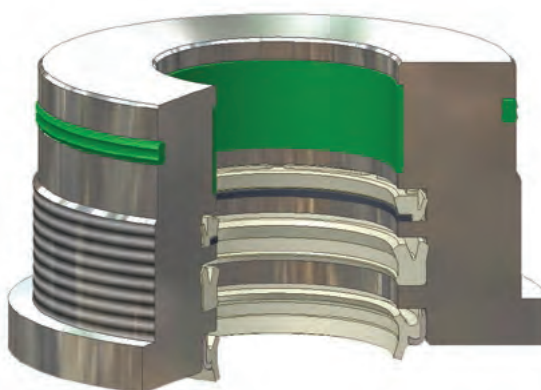

HS installed in Static Head Gland

Part Number Nomenclature – HS Profile

Table 11-9. HS Profile – Inch

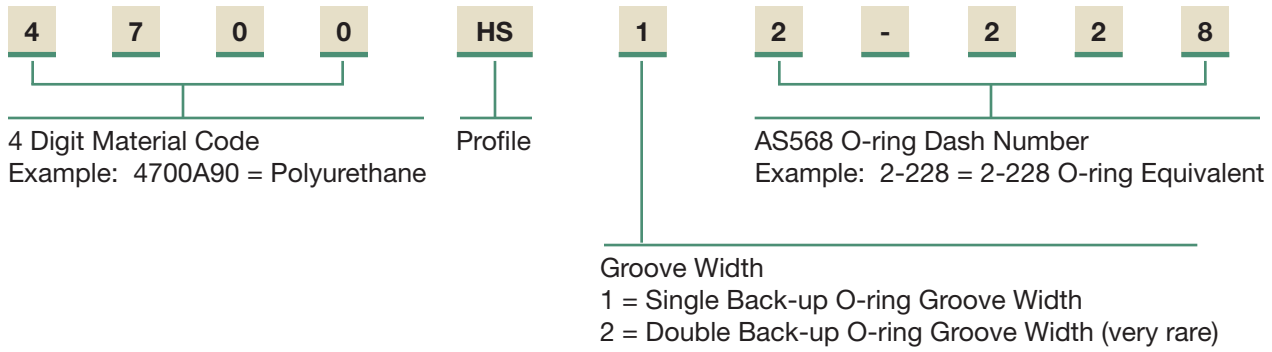

Gland Dimensions – HS Profile

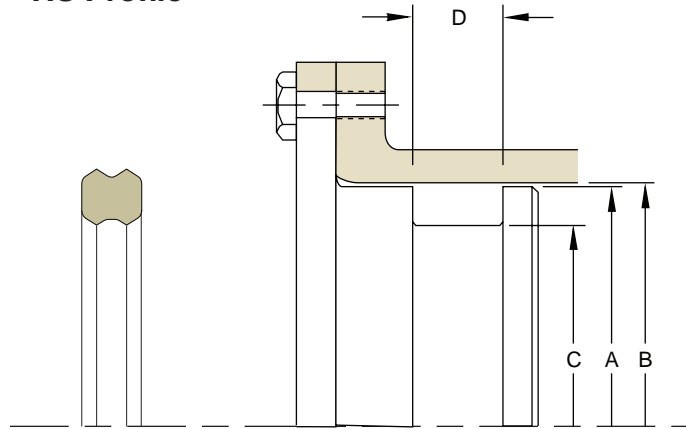

Table 11-10. HS Gland Dimensions – Inch

O-ring 2-Size AS568	Gland Dimensions				Part Number
	A Head Diameter	B Bore Diameter	C Groove Diameter	D Groove Width	
	+0.000/-0.001	+0.002/-0.000	+0.000/-0.002	+0.005/-0.000	
228	2.497	2.500	2.278	0.208	4700HS12-228
230	2.747	2.750	2.528	0.208	4700HS12-230
232	2.997	3.000	2.778	0.208	4700HS12-232
234	3.247	3.250	3.028	0.208	4700HS12-234
235	3.372	3.375	3.153	0.208	4700HS12-235
236	3.497	3.500	3.278	0.208	4700HS12-236
238	3.747	3.750	3.528	0.208	4700HS12-238
240	3.997	4.000	3.778	0.208	4700HS12-240
242	4.247	4.250	4.028	0.208	4700HS12-242
244	4.497	4.500	4.278	0.208	4700HS12-244
246	4.747	4.750	4.528	0.208	4700HS12-246
248	4.997	5.000	4.778	0.208	4700HS12-248
	+0.000/-0.001	+0.002/-0.000	+0.000/-0.004	+0.005/-0.000	
250	5.247	5.250	5.028	0.208	4700HS12-250
251	5.372	5.375	5.153	0.208	4700HS12-251

Table 11-10. HS Gland Dimensions — Inch (Continued)

O-ring 2-Size AS568	Gland Dimensions				Part Number
	A Head Diameter +0.000/-0.001	B Bore Diameter +0.002/-0.000	C Groove Diameter +0.000/-0.004	D Groove Width +0.005/-0.000	
252	5.497	5.500	5.278	0.208	4700HS12-252
254	5.747	5.750	5.528	0.208	4700HS12-254
256	5.997	6.000	5.778	0.208	4700HS12-256
342	3.997	4.000	3.660	0.311	4700HS12-342
344	4.247	4.250	3.910	0.311	4700HS12-344
346	4.497	4.500	4.160	0.311	4700HS12-346
348	4.747	4.750	4.410	0.311	4700HS12-348
350	4.997	5.000	4.660	0.311	4700HS12-350
352	5.247	5.250	4.910	0.311	4700HS12-352
353	5.372	5.375	5.035	0.311	4700HS12-353
354	5.497	5.500	5.160	0.311	4700HS12-354
356	5.747	5.750	5.410	0.311	4700HS12-356
358	5.997	6.000	5.660	0.311	4700HS12-358
360	6.247	6.250	5.910	0.311	4700HS12-360

NOTE: For sizes larger than those shown in the table, please contact your local Parker seal representative.

Metric Seals

Contents

Product Offering 12-2

Metric Seal Profiles

- ◆ BT Profile, Rod Seal..... 12-3
- ◆ AY Profile, Rod Wiper 12-5
- ◆ BP Profile, Piston Seal..... 12-7

Metric Seal Profiles

Parker’s extensive portfolio of sealing profiles, compounds and dimensions for precision hydraulic sealing is the result of many years of development and field experience gained in the various sectors of mechanical engineering. The profiles, materials and sizes shown here as Preferred Profiles were selected based on existing ISO standards and recommended suitability for a broad range of applications.

Parker offers a comprehensive range of solutions to manufacturers of hydraulics equipment. Contact our application engineering experts if you need assistance with alternate profiles and sizes.

Typical Hydraulic Cylinder

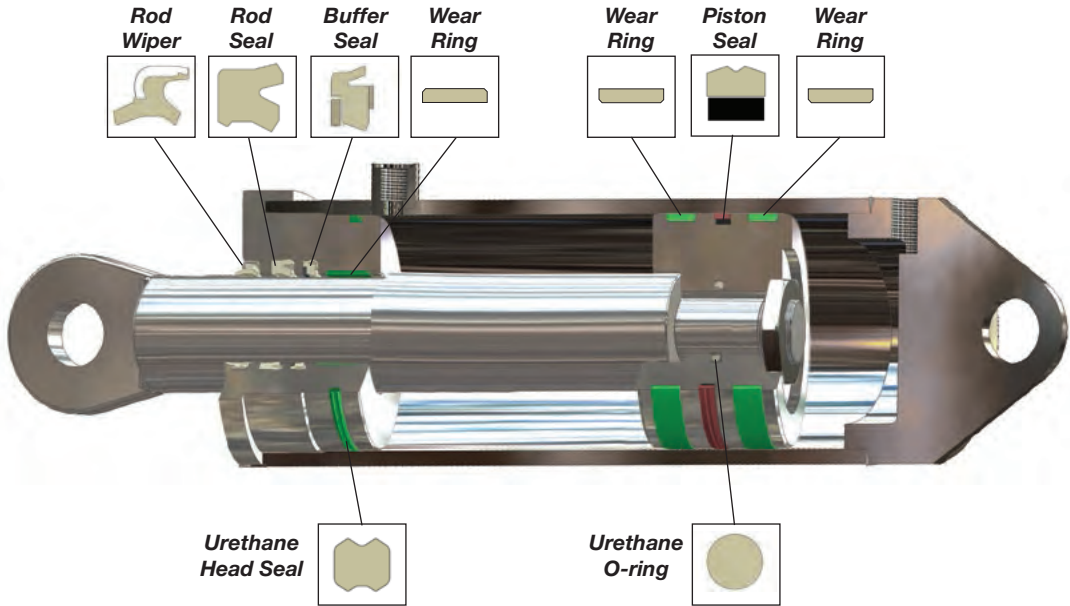











Metric Seal Product Offering

Catalog EPS 5370/USA

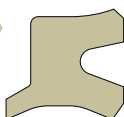
Profiles

Table 12-1: Product Profiles

◆ = Preferred Metric Seal profile

Series	Description	Application (Duty)				Page
		Light	Medium	Heavy	Pneu	
◆ BT	U-cup Rod Seal 					12-3
◆ AY	Double-Lip Rod Seal 					12-5
◆ BP	Bi-directional Piston Seal 					12-7

Rod Seal

BT Metric Profile ◆ Preferred Profile

Catalog EPS 5370/USA



BT Profile, Premium U-cup Rod Seal with Secondary Stabilizing Lip

The BT profile is a non-symmetrical design for use in hydraulic rod sealing applications. Using Finite Element Analysis, the BT profile was designed to provide improved sealing performance and stability in the gland. A knife trimming process is used to form the beveled lip which is best for removing fluid from the rod. By design, the BT profile has a more robust primary sealing lip than the BS profile and the stabilizing lip is located at the base of the heel. The standard compound for the BT profile is Parker's proprietary Resilon® polyurethane compound. The BT profile provides long life, extrusion resistance, low compression set, shock load resistance and increased sealing performance at zero pressure. The BT profile is designed for use as a stand alone rod seal or for use with the BR or OD profile buffer seals for more critical sealing applications.

Technical Data

Standard Materials	Temperature Range	Pressure Range†	Surface Speed
P4300A90	-65°F to +275°F (-54°C to +135°C)	5000 psi (344 bar)	< 1.6 ft/s (0.5 m/s)

* **Dimensions:** Dimensions according to ISO 5597.

† **Pressure Range** without wear rings (see [Table 2-4](#), [page 2-5](#)).

Special Operating Conditions: For special operating conditions (specific pressure, temperature, speed, use of water, HFA, HFB fluids, etc.), please contact Parker's application engineering team.



BT Cross-Section

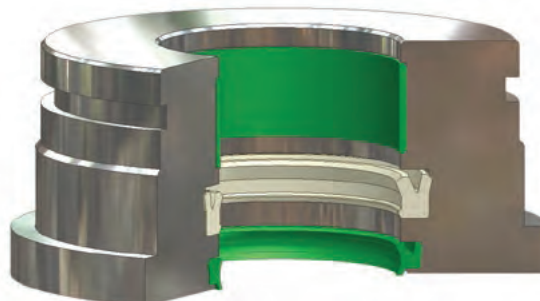

BT Installed in Rod Gland

Gland Dimensions – BT Metric Profile

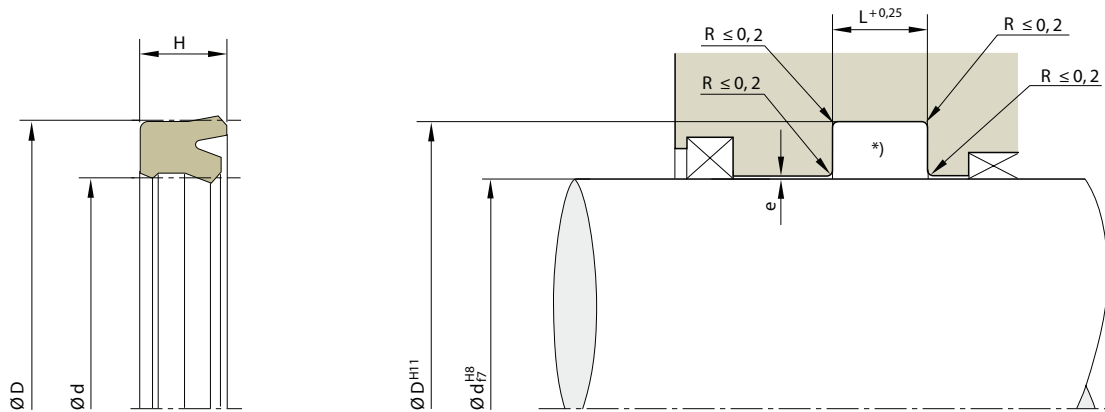

Please refer to Engineering Section 2, page 2-8 for surface finish and additional hardware considerations.

Table 12-2. B3 Profile – Gland Dimensions and Part Number

d	D	H	L	ISO ¹⁾	ISO ²⁾	Part Number
25	35	7.3	8		•	M300BT05.0025-7.3
28	36	5.7	6.3	•	•	M300BT04.0028-5.7
32	42	7.3	8		•	M300BT05.0032-7.3
36	44	5.7	6.3	•	•	M300BT04.0036-5.7
40	50	7.3	8		•	M300BT05.0040-7.3
45	53	5.6	6.3	•	•	M300BT04.0045-5.6
50	60	7.3	8		•	M300BT05.0050-7.3
55	65	7.3	8			M300BT05.0055-7.3
56	66	6.5	7.5	•	•	M300BT05.0056-6.5
63	78	11.4	12.5		•	M300BT07.5063-11.4
65	80	9.0	9.6			M300BT07.5065-9
70	85	11.4	12.5		•	M300BT07.5070-11.4
80	95	9.0	9.6			M300BT07.5080-9
80	95	11.4	12.5		•	M300BT07.5080-11.4
90	100	6.5	7.5	•	•	M300BT05.0090-6.5
100	120	14.5	16		•	M300BT10.0100-14.5
110	125	9.6	10.6	•	•	M300BT07.5110-9.6
125	145	14.5	16		•	M300BT10.0125-14.5
140	155	9.6	10.6	•	•	M300BT07.5140-9.6
160	185	18.2	20		•	M300BT12.5160-18.2
180	205	18.2	20		•	M300BT12.5180-18.2
200	225	18.2	20		•	M300BT12.5200-18.2
220	250	22.7	25		•	M300BT15.0220-22.7
250	280	22.7	25		•	M300BT15.0250-22.7
280	310	22.7	25		•	M300BT15.0280-22.7

See Appendix G for tolerances.

*In the case of designs according to ISO standard, the radii given there should be used.

1) For housings according to ISO 5597 for ISO 6020-2 cylinders.

2) Standard sizes for housings according to ISO 5597.

Rod Wiper

AY Metric Profile ◆ Preferred Profile

Catalog EPS 5370/USA

AY Profile, Double-Lip Wiper



The AY profile can be used as a heavy to light duty wiper. When used in high pressure applications with the proper Parker rod seals, the AY complements the sealing system by providing an additional beveled sealing lip, yielding excellent film-breaking and the driest rod sealing available. These dual acting features also enable it to be used by itself in low pressure applications as both the rod seal and the wiper. Knife-trimmed sealing lips ensure the best possible film breaking.

IMPORTANT: When using the AY wiper in conjunction with other rod seals, it is important to select a rod seal profile that enables pressure relief of fluid into the system, otherwise a pressure trap may form between the wiper and rod seal. Suggested rod seal profile is BT Profile u-cup.

Technical Data

Standard Materials	Temperature Range	Surface Speed
P4300A90	-65°F to +275°F (-54°C to +135°C)	<1.6 ft/s (0.5 m/s)

Dimensions according to DIN ISO 6195, Type C.

Special Operating Conditions: For special operating conditions (specific pressure, temperature, speed, use in water, HFA, HFB fluids etc.), please contact Parker's application engineering team.

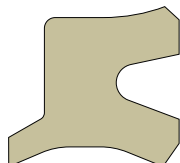

AY Cross-Section

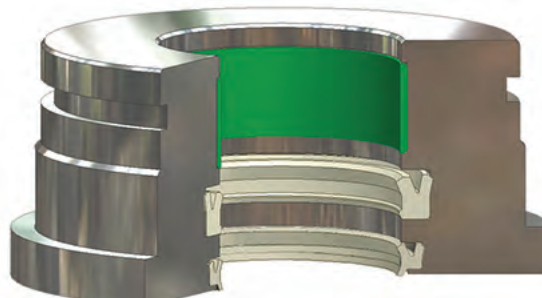

AY installed in Rod Gland

Gland Dimensions – AY Profile

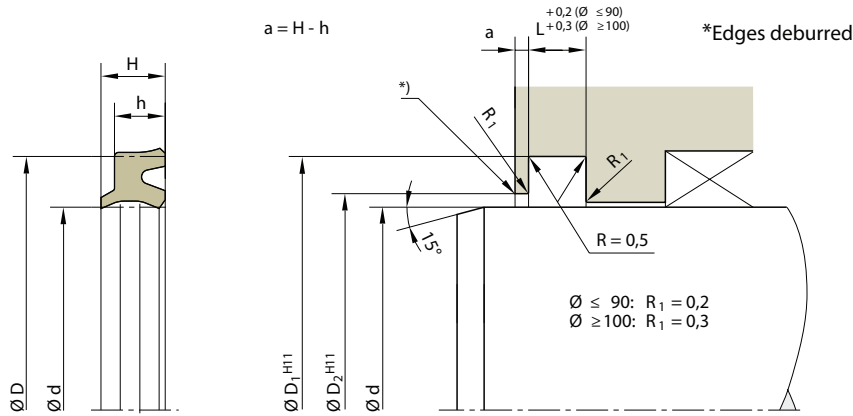

Please refer to Engineering [Section 2](#), [page 2-8](#) for surface finish and additional hardware considerations.

Table 12-3. AY Metric Profile – Gland Dimensions and Part Number

d	D	H	h	D2	L	ISO ¹⁾	Part Number
20	26	4.8	3.6	22.5	4	•	M300AY03.0020-3.6
25	31	4.8	3.6	27.5	4	•	M300AY03.0025-3.6
28	36	5.8	4.5	31	5	•	M300AY04.0028-4.5
32	40	5.8	4.5	35	5	•	M300AY04.0032-4.5
36	44	5.8	4.5	39	5	•	M300AY04.0036-4.5
40	48	5.8	4.5	43	5	•	M300AY04.0040-4.5
45	53	5.8	4.5	48	5	•	M300AY04.0045-4.5
50	58	5.8	5.0	53	5		M300AY04.0050-5.0
55	65	5.8	4.5	58	5		M300AY05.0055-4.5
55	65	6.8	5.3	58	6		M300AY05.0055-5.3
56	66	6.8	5.3	59	6	•	M300AY05.0056-5.3
63	73	6.8	5.3	66	6	•	M300AY05.0063-5.3
64	74	6.8	5.3	67	6		M300AY05.0064-5.3
70	80	6.8	5.3	73	6	•	M300AY05.0070-5.3
75	85	6.8	5.3	78	6		M300AY05.0075-5.3
80	90	6.8	5.3	83	6	•	M300AY05.0080-5.3
90	100	6.8	5.3	93	6	•	M300AY05.0090-5.3
100	110	6.8	5.3	103	6	•	M300AY05.0100-5.3
110	125	9.5	7.5	114	8.5	•	M300AY07.5110-7.5
120	135	9.5	7.5	124	8.5	•	M300AY07.5120-7.5
125	140	9.5	7.5	129	8.5	•	M300AY07.5120-7.5
140	155	9.5	7.5	144	8.5	•	M300AY07.50140-7.5
160	175	9.5	7.5	164	8.5	•	M300AY07.50160-7.5

See [Appendix G](#) for tolerances.

1) DIN ISO 6195, Type C, for ISO 6020-2 cylinders

Further sizes on request.

Piston Seal

BP Metric Profile **◆ Preferred Profile**

Catalog EPS 5370/USA

BP Profile, Premium TPU Cap Seal



Parker's metric BP profile is a double-acting, squeeze type, piston seal for use in medium to heavy duty hydraulic applications. The standard material combination for the profile's components are a TPU cap in Resilon® 4304 polyurethane with improved sliding and high modulus, and a rectangular cross-section NBR elastomer energizer. The BP profile is easy to install on a single part piston. The unique cap design of the BP profile makes the seal insensitive to pressure spikes.

The BP profile is sold only as an assembly (seal and energizer).

Technical Data

Standard Materials	Temperature Range	Pressure Range†	Surface Speed
Cap P4304D60	-65°F to +275°F (-54°C to +135°C)	7,000 psi (482 bar)	< 1.6 ft/s (0.5 m/s)
Energizer A 70A Nitrile	-30°F to +250°F (-34°C to +121°C)		

* **Dimensions:** Dimensions according to ISO 7425-1.

†**Pressure Range** without wear rings. If used with wear rings, see [Table 2-4, page 2-5](#).



Metric BP Cross-Section

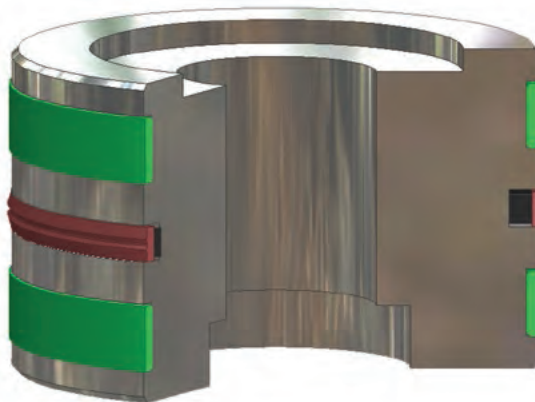

BP installed in Piston Gland

Gland Dimensions – BP Metric Profile

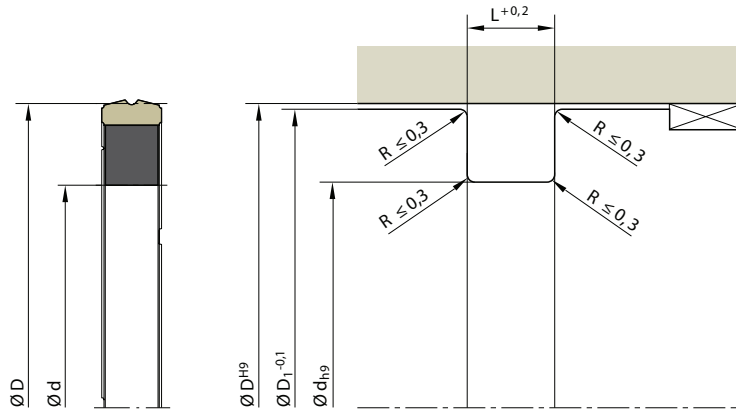

Please refer to Engineering [Section 2, page 2-8](#) for surface finish and additional hardware considerations.

Table 12-4. BP Metric Profile – Gland Dimensions and Part Number

D	d	L	D1	ISO ¹⁾	Order Code
32	24.5	3.2	31.7	•	M304BP03.7032-3.2A
40	32.5	3.2	39.7	•	M304BP03.7040-3.2A
50	39	4.2	49.7	•	M304BP05.5050-4.2A
63	52	4.2	63.7	•	M304BP05.5063-4.2A
80	69	4.2	79.7	•	M304BP05.5080-4.2A
85	69.5	6.3	84.7		M304BP07.7080-6.3A
90	69	8.1	89.5		M304BP10.5090-8.1A
95	79.5	6.3	94.6		M304BP07.7095-6.3A
100	79	8	100		M304BP10.5100-8.1A
125	109.5	6.3	124.6	•	M304BP07.7125-6.3A
140	119	8.1	139.5		M304BP10.5140-8.1A
150	129	10.5	149.5		M304BP10.5150-10.5A
160	139	8.1	159.5	•	M304BP10.5160-8.1A
200	179	8.1	199.5	•	M304BP10.5200-8.1A

See [Appendix G](#) for tolerances.

1) ISO 7425-1

Appendix Table of Contents

Click to Go to
CATALOG
Table of Contents

[Design Action Request Form](#)

A

[English / Metric Conversions](#)

B

[Custom Groove Calculations](#)

C

[AN6226 Gland Dimensions
& Tolerances \(Army / Navy\)](#)

D

[MS-28776 \(MS-33675\) Dash Size
Grooves \(for SH959 Profile Wipers\)](#)

E

[Commercial PTFE Back-Ups for Retrofit
MS-28774 and MS-27595 Grooves](#)

F

[ISO Gland Tolerances](#)

G



Parker Hannifin Corporation
Engineered Polymer Systems Division
Phone: 801 972 3000
Fax: 801 973 4019

www.parkerseals.com

[Click to Go to
CATALOG
Table of Contents](#)

Design Action Request Form

NEED HELP? If you need assistance, please photocopy these pages. Fill out the required information and fax to 801 973 4019. Submit a sketch if necessary. Use the information below and other information in this catalog to determine the dimensions needed. We will contact you to discuss your specific application and make recommendations. If you need help filling out this form, please call Parker's Applications Engineering team at 801 972 3000.

ENGINEERED POLYMER SYSTEMS DIVISION DESIGN ACTION REQUEST

EPS Division

2220 South 3600 West
Salt Lake City, UT
Tel: (801) 972-3000
Fax: (801) 973-4019

Applications Engineering Use:

Project # _____
Date Entered _____
Date Required _____
Prepared by _____
Territory Mgr. _____
Distributor _____
Dist. Sales _____

Referred by _____
Lead # _____

COMPANY: _____ FAX NUMBER: _____
ADDRESS: _____ P.O. BOX: _____ MAIL STOP: _____
CITY: _____ STATE: _____ ZIP: _____ COUNTRY: _____
CONTACT: _____ TITLE: _____ PHONE: _____ EXT: _____
ALT. CONTACT: _____ TITLE: _____ PHONE: _____ EXT: _____
E-MAIL: _____

EQUIPMENT/MANUFACTURER: _____ MODEL NO.: _____
EXISTING SEAL MANUFACTURER: _____ PART NO.: _____
REASON FOR CHANGE: PERFORMANCE DELIVERY NEW APPLICATION PRICE
CURRENT PRICE: _____ @ _____ PCS. MONTHLY USAGE: _____ HOURS OPERATION: _____ HOURS SERV. LIFE: _____
TARGET PRICE: _____ @ _____ PCS. QUOTE QTY.: _____ PROTO QTY.: _____ DATE PROTO REQ'D.: _____
SPECIAL INSPECTION REQUIREMENTS: YES NO SPECIAL PACKAGING REQUIREMENTS: YES NO
EXPLAIN: _____

MOTION

STATIC RECIPROCATING OSCILLATORY ROTARY

PRODUCT TYPE

NON-ROTARY — FILL OUT SECOND PAGE

ROD/SHAFT WIPER
 PISTON BEARING
 INTERNAL FACE VANE
 EXTERNAL FACE NON-SEAL

ROTARY — FILL OUT THIRD PAGE

SOLID SEAL PTFE LIP SEAL
 SPLIT SEAL ELASTOMER LIP SEAL
 BEARING ISOLATOR

Design Action Request Form

OPERATING PARAMETERS	UNIT (CIRCLE ONE)	MINIMUM	OPERATING	MAXIMUM
TEMPERATURE:	°K °F °C	_____	_____	_____
PRESSURE:	PSI BAR MPA	_____	_____	_____
STROKE LENGTH (RECIPROCATING):	INCH MM	_____	_____	_____
CYCLE RATE:	CYCLES/MIN CYCLES/HR HZ	_____	_____	_____
DEGREE OF ARC (OSCILLATING):	DEGREES	_____	_____	_____
VELOCITY:	FT/MIN. MM/MIN.	_____	_____	_____
VACUUM:	IN HG TORR	_____	_____	_____
ROTARY SPEED	RPM	_____	_____	_____
MEDIA TO BE SEALED: _____				

Rod

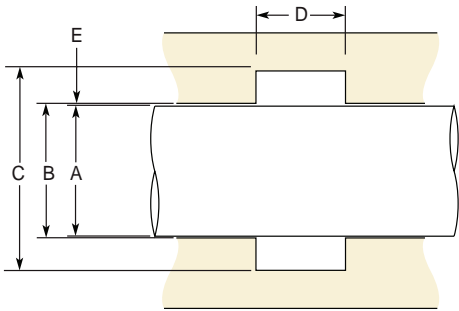

Piston

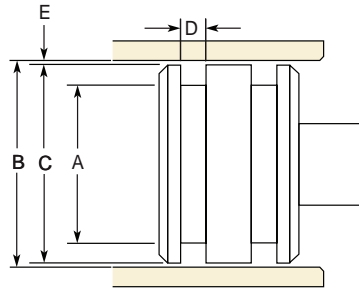

Face Seal

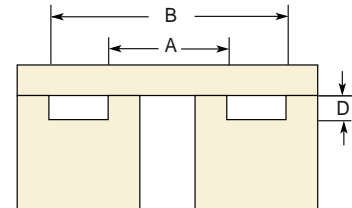

Other Piston

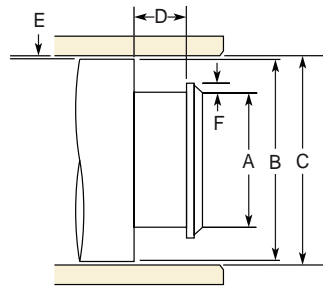

Other Rod

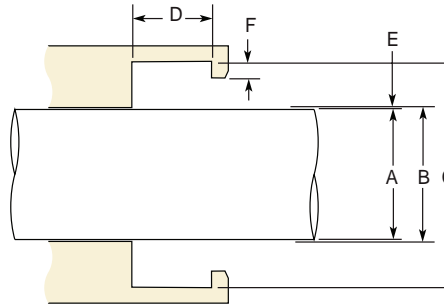

HARDWARE SPECIFICATIONS

A DIAMETER: MIN. _____ MAX. _____
 B DIAMETER: MIN. _____ MAX. _____
 C DIAMETER: MIN. _____ MAX. _____
 D GROOVE WIDTH: MIN. _____ MAX. _____
 E RADIAL CLEARANCE: MIN. _____ MAX. _____
 F ROD / PISTON STEP HEIGHT: MIN. _____ MAX. _____
 SIDE LOAD (LBS. NEWTONS): _____
 MIL-G-5514 O-RING DASH #: _____ BACK-UP WIDTH _____
 AS4716 O-RING DASH #: _____ BACK-UP WIDTH _____
 RUNOUT (TIR) _____
 ECCENTRICITY _____

HARDWARE DRAWINGS INCLUDED WITH DAR: YES NO
 HARDNESS _____ FINISH _____ MAT'L _____
 HARDNESS _____ FINISH _____ MAT'L _____
 HARDNESS _____ FINISH _____ MAT'L _____
 CAN HARDWARE BE CHANGED? YES NO
 HOW? _____

PERFORMANCE REQUIREMENTS (CIRCLE ONE)

FRICITION: LBS OZ GMS BREAKOUT _____ DYNAMIC _____
 EXPECTED LIFE: CYC HRS YRS _____
 MAX. LEAKAGE: DROPS CC/MIN _____
 MOST CRITICAL ASPECT: _____
 CONTAMINATION: _____

GLAND TYPE

____ SPLIT ____ OPEN

METRIC

YES

Click to Go to
CATALOG
Table of Contents

English / Metric Conversions: Fractions

Catalog EPS 5370/USA

B

Fractional	Decimal	Metric
—	0.004	0.10
—	0.010	0.25
1/64	0.016	0.40
—	0.020	0.50
—	0.030	0.75
1/32	0.031	0.79
—	0.039	1.00
3/64	0.047	1.19
—	0.059	1.50
1/16	0.063	1.59
5/64	0.078	1.98
—	0.079	2.00
3/32	0.094	2.38
—	0.098	2.50
7/64	0.109	2.78
—	0.118	3.00
1/8	0.125	3.18
—	0.138	3.50
9/64	0.141	3.57
5/32	0.156	3.97
—	0.158	4.00
11/64	0.172	4.37
—	0.177	4.50
3/16	0.188	4.76
—	0.197	5.00
13/64	0.203	5.16
—	0.217	5.50
7/32	0.219	5.56
15/64	0.234	5.95
—	0.236	6.00
1/4	0.250	6.35
—	0.256	6.50
17/64	0.266	6.75
—	0.276	7.00
9/32	0.281	7.14
—	0.295	7.50
19/64	0.297	7.54
5/16	0.313	7.94
—	0.315	8.00
21/64	0.328	8.33
—	0.335	8.50
11/32	0.344	8.73
—	0.354	9.00
23/64	0.359	9.13
—	0.374	9.50
3/8	0.375	9.53
25/64	0.391	9.92
—	0.394	10.00
12/32	0.406	10.32
—	0.413	10.50
27/64	0.422	10.72
—	0.433	11.00
7/16	0.438	11.11
29/64	0.453	11.51
15/32	0.469	11.91
—	0.472	12.00
31/64	0.484	12.30
—	0.492	12.50
1/2	0.500	12.70
—	0.512	13.00
33/64	0.516	13.10
17/32	0.531	13.50
35/64	0.547	13.90
—	0.551	14.00
9/16	0.563	14.29
—	0.571	14.50

Fractional	Decimal	Metric
37/64	0.578	14.68
—	0.591	15.00
19/32	0.594	15.08
39/64	0.609	15.48
5/8	0.625	15.88
—	0.630	16.00
41/64	0.641	16.27
—	0.650	16.50
21/32	0.656	16.67
—	0.669	17.00
43/64	0.672	17.01
11/16	0.688	17.46
45/64	0.703	17.86
—	0.709	18.00
23/32	0.719	18.26
—	0.728	18.49
47/64	0.734	18.65
—	0.748	19.00
3/4	0.750	19.05
49/64	0.766	19.45
25/32	0.781	19.84
—	0.787	20.00
51/64	0.797	20.24
13/16	0.813	20.64
—	0.827	21.00
53/64	0.828	21.03
27/32	0.844	21.43
55/64	0.859	21.83
—	0.866	22.00
7/8	0.875	22.23
57/64	0.891	22.62
—	0.906	23.00
29/32	0.906	23.02
59/64	0.922	23.42
15/16	0.938	23.81
—	0.945	24.00
61/64	0.953	24.21
31/32	0.969	24.61
—	0.984	25.00
1	1.000	25.40
—	1.024	26.00
11/32	1.031	26.19
11/16	1.062	26.99
—	1.063	27.00
13/32	1.094	27.78
—	1.102	28.00
11/8	1.125	28.58
—	1.148	29.00
15/32	1.156	29.37
—	1.181	30.00
13/16	1.188	30.16
17/32	1.219	30.96
—	1.221	31.00
11/4	1.250	31.75
—	1.260	32.00
19/32	1.281	32.54
—	1.299	33.00
15/16	1.312	33.34
—	1.339	34.00
111/32	1.344	34.13
13/8	1.375	34.93
—	1.378	35.00
113/32	1.406	35.72
—	1.417	36.00
17/16	1.438	36.51
—	1.457	37.00

Fractional	Decimal	Metric
115/32	1.469	37.31
—	1.496	38.00
11/2	1.500	38.10
117/32	1.531	38.89
—	1.535	39.00
19/16	1.562	39.69
—	1.575	40.00
119/64	1.594	40.48
—	1.614	41.00
15/8	1.625	41.28
—	1.654	42.00
121/32	1.656	42.07
111/16	1.688	42.86
—	1.693	43.00
123/32	1.719	43.66
—	1.732	44.00
13/4	1.750	44.50
—	1.772	45.00
125/32	1.781	45.24
—	1.811	46.00
1131/64	1.813	46.04
127/32	1.844	46.83
—	1.850	47.00
17/8	1.875	47.63
—	1.890	48.00
129/32	1.906	48.42
—	1.929	49.00
115/16	1.938	49.21
—	1.970	50.00
131/32	1.970	50.01
2	2.000	50.80
—	2.008	51.00
—	2.047	52.00
21/16	2.062	52.39
—	2.087	53.00
21/8	2.125	53.98
—	2.126	54.00
—	2.165	55.00
23/16	2.188	55.56
—	2.205	56.00
—	2.244	57.00
21/4	2.250	57.15
—	2.284	58.00
25/16	2.312	58.74
—	2.323	59.00
—	2.362	60.00
23/8	2.375	60.33
—	2.402	61.00
27/16	2.438	61.91
—	2.441	62.00
—	2.480	63.00
21/2	2.500	63.50
—	2.520	64.00
—	2.559	65.00
29/16	2.562	65.09
—	2.598	66.00
25/8	2.625	66.68
—	2.638	67.00
—	2.677	68.00
211/16	2.688	68.26
—	2.717	69.00
23/4	2.750	69.85
—	2.756	70.00
—	2.795	71.00
213/16	2.813	71.44
—	2.835	72.00

Fractional	Decimal	Metric
—	2.874	73.00
27/8	2.875	73.03
—	2.913	74.00
215/16	2.938	74.61
—	2.953	75.00
—	2.992	76.00
3	3.000	76.20
—	3.032	77.00
31/16	3.062	77.79
—	3.071	78.00
—	3.110	79.00
31/8	3.125	79.38
—	3.150	80.00
33/16	3.188	80.96
—	3.189	81.00
—	3.228	82.00
31/4	3.250	82.55
—	3.268	83.00
—	3.307	84.00
35/16	3.312	84.14
—	3.346	85.00
33/8	3.375	85.73
—	3.386	86.00
—	3.425	87.00
37/16	3.438	87.31
—	3.465	88.00
—	3.500	88.90
31/2	3.504	89.00
—	3.543	90.00
39/16	3.562	90.49
—	3.583	91.00
—	3.622	92.00
35/8	3.625	92.08
—	3.661	93.00
311/16	3.688	93.66
—	3.701	94.00
—	3.740	95.00
33/4	3.750	95.25
—	3.780	96.00
313/16	3.813	96.84
—	3.819	97.00
—	3.858	98.00
37/8	3.875	98.43
—	3.898	99.00
—	3.937	100.00
315/16	3.938	100.01
—	3.976	101.00
4	4.000	101.60
41/16	4.062	103.19
41/8	4.125	104.78
—	4.134	105.00
43/16	4.188	106.36
41/4	4.250	107.95
45/16	4.312	109.54
—	4.331	110.00
43/8	4.375	111.13
47/16	4.438	112.71
41/2	4.500	114.30
—	4.528	115.00
49/16	4.562	115.89
45/8	4.625	117.48
—	4.724	120.00
43/4	4.750	120.65
47/8	4.875	123.83
—	4.921	125.00
5	5.000	127.00



RPM to FPM Conversion

B

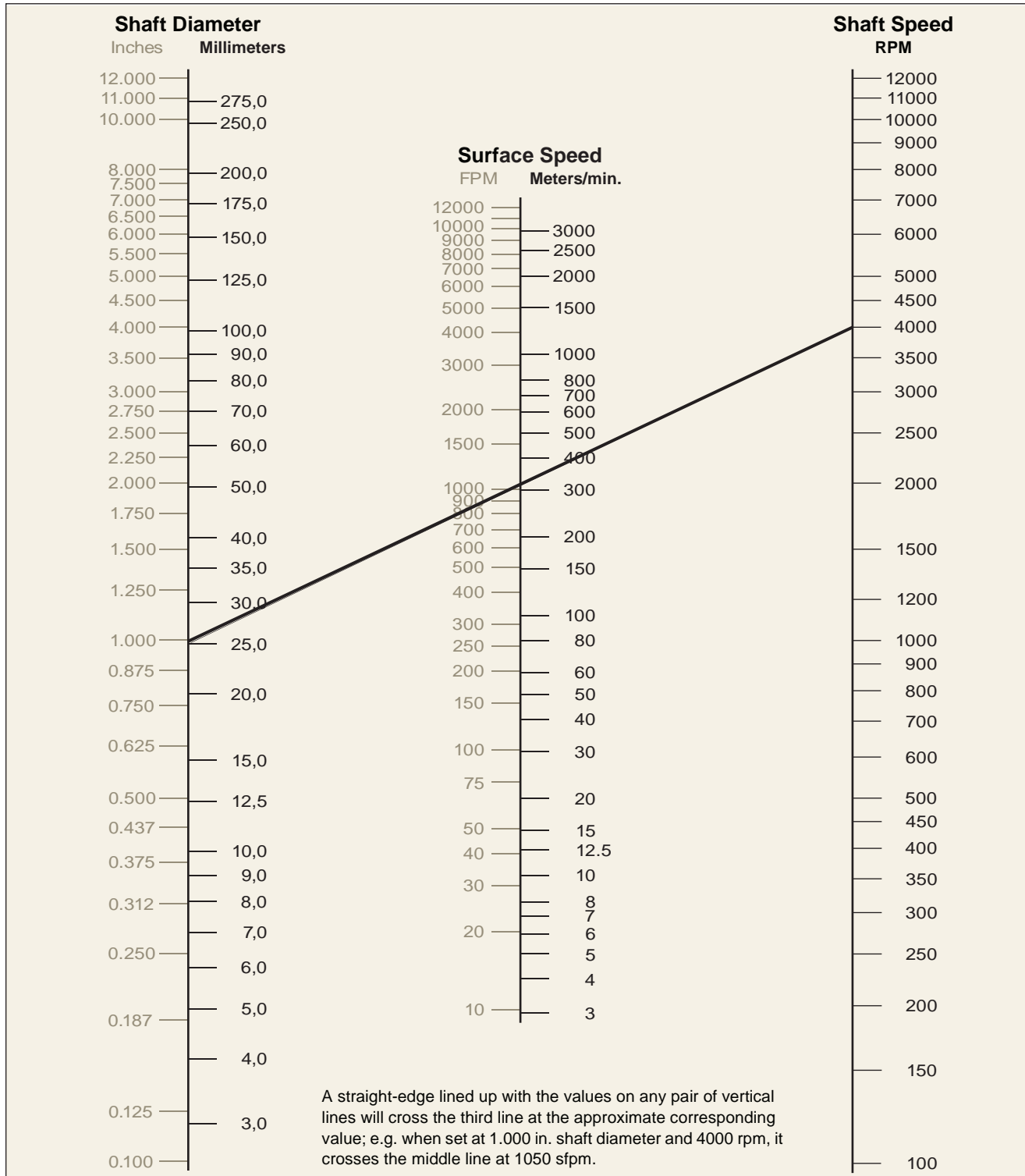

Pressure: PSI / Bar

1-40		41-80		81-200		205-500		510-900		910-1500	
psi	bar	psi	bar	psi	bar	psi	bar	psi	bar	psi	bar
1	0.07	41	2.83	81	5.59	205	14.13	510	35.17	910	62.76
2	0.14	42	2.90	82	5.65	210	14.48	520	35.86	920	63.45
3	0.21	43	2.97	83	5.72	215	14.82	530	36.55	930	64.14
4	0.28	44	3.03	84	5.79	220	15.17	540	37.24	940	64.83
5	0.34	45	3.10	85	5.86	225	15.51	550	37.92	950	65.52
6	0.41	46	3.17	86	5.93	230	15.86	560	38.62	960	66.21
7	0.48	47	3.24	87	6.00	235	16.20	570	39.31	970	66.90
8	0.55	48	3.31	88	6.07	240	16.55	580	40.00	980	67.59
9	0.62	49	3.38	89	6.14	245	16.89	590	40.69	990	68.28
10	0.69	50	3.45	90	6.21	250	17.24	600	41.37	1000	68.95
11	0.76	51	3.52	91	6.27	255	17.58	610	42.07	1010	69.66
12	0.83	52	3.59	92	6.34	260	17.93	620	42.76	1020	70.34
13	0.90	53	3.65	93	6.41	265	18.27	630	43.45	1030	71.03
14	0.97	54	3.72	94	6.48	270	18.62	640	44.14	1040	71.72
15	1.03	55	3.79	95	6.55	275	18.96	650	44.82	1050	72.41
16	1.10	56	3.86	96	6.62	280	19.31	660	45.52	1060	73.10
17	1.17	57	3.93	97	6.69	285	19.65	670	46.21	1070	73.79
18	1.24	58	4.00	98	6.76	290	20.20	680	43.90	1080	74.48
19	1.31	59	4.07	99	6.83	295	20.34	690	47.59	1090	75.17
20	1.38	60	4.14	100	6.90	300	20.69	700	48.27	1100	75.86
21	1.45	61	4.21	105	7.24	310	21.37	710	48.97	1120	77.24
22	1.52	62	4.28	110	7.58	320	22.06	720	49.66	1140	78.62
23	1.59	63	4.34	115	7.93	330	22.75	730	50.34	1160	80.00
24	1.65	64	4.41	120	8.27	340	23.44	740	51.03	1180	81.38
25	1.72	65	4.48	125	8.62	350	24.13	750	51.71	1200	82.76
26	1.79	66	4.55	130	8.89	360	24.82	760	52.41	1220	84.14
27	1.86	67	4.62	135	9.31	370	25.51	770	53.10	1240	85.52
28	1.93	68	4.69	140	9.65	380	26.21	780	53.79	1260	86.90
29	2.00	69	4.76	145	10.10	390	26.89	790	54.48	1280	88.28
30	2.07	70	4.83	150	10.34	400	27.85	800	55.16	1300	89.66
31	2.14	71	4.90	155	10.69	410	28.27	810	55.86	1320	91.03
32	2.21	72	4.97	160	11.03	420	28.96	820	56.55	1340	92.41
33	2.28	73	5.03	165	11.38	430	29.65	830	57.24	1360	93.79
34	2.34	74	5.10	170	11.72	440	30.34	840	57.93	1380	95.17
35	2.41	75	5.17	175	12.07	450	31.03	850	58.61	1400	96.55
36	2.48	76	5.24	180	12.41	460	31.72	860	59.31	1420	97.93
37	2.55	77	5.31	185	12.76	470	32.41	870	60.00	1440	99.31
38	2.62	78	5.38	190	13.10	480	33.10	880	60.69	1460	100.69
39	2.69	79	5.45	195	13.45	490	33.79	890	61.38	1480	102.07
40	2.76	80	5.52	200	13.79	500	34.48	900	62.06	1500	103.45

Temperature: Celsius / Fahrenheit

B

Celsius	Fahrenheit
-169	-273
-168	-270
-162	-260
-157	-250
-151	-240
-146	-230
-140	-220
-134	-210
-129	-200
-123	-190
-118	-180
-112	-170
-107	-160
-101	-150
-96	-140
-90	-130
-84	-120
-79	-110
-73	-100
-68	-90
-62	-80
-57	-70
-51	-60
-46	-50
-40	-40
-34	-30
-29	-20
-23	-10
-17.8	0
-17.2	1
-16.7	2
-16.1	3
-15.6	4
-15	5
-14.4	6
-13.9	7
-13.3	8
-12.8	9
-12.2	10
-11.7	11
-11.1	12
-10.6	13
-10	14
-9.4	15
-8.9	16
-8.3	17

Celsius	Fahrenheit
-7.8	18
-7.2	19
-6.7	20
-6.1	21
-5.6	22
-5	23
-4.4	24
-3.9	25
-3.3	26
-2.8	27
-2.2	28
-1.7	29
-1.1	30
-0.6	31
0	32
0.6	33
1.1	34
1.7	35
2.2	36
2.8	37
3.3	38
3.9	39
4.4	40
5	41
5.6	42
6.1	43
6.7	44
7.2	45
7.8	46
8.3	47
8.9	48
9.4	49
10	50
10.6	51
11.1	52
11.7	53
12.2	54
12.8	55
13.3	56
13.9	57
14.4	58
15	59
15.6	60
16.1	61
16.7	62
17.2	63

Celsius	Fahrenheit
17.8	64
18.3	65
18.9	66
19.4	67
20	68
20.6	69
21.1	70
21.7	71
22.2	72
22.8	73
23.3	74
23.9	75
24.4	76
25	77
25.6	78
26.1	79
26.7	80
27.2	81
27.8	82
28.3	83
28.9	84
29.4	85
30	86
30.6	87
31.1	88
31.7	89
32.2	90
32.8	91
33.3	92
33.9	93
34.4	94
35	95
35.6	96
36.1	97
36.7	98
37.2	99
37.8	100
43	110
49	120
54	130
60	140
66	150
71	160
77	170
82	180
88	190

Celsius	Fahrenheit
93	200
99	210
100	212
104	220
110	230
116	240
121	250
127	260
132	270
138	280
143	290
149	300
154	310
160	320
166	330
171	340
177	350
182	360
188	370
193	380
199	390
204	400
210	410
216	420
221	430
227	440
232	450
238	460
243	470
249	480
254	490
260	500
266	510
271	520
277	530
282	540
288	550
293	560
299	570
304	580
310	590
316	600
321	610
327	620
332	630
338	640

Celsius	Fahrenheit
343	650
349	660
354	670
360	680
366	690
371	700
377	710
382	720
388	730
393	740
399	750
404	760
410	770
416	780
421	790
427	800
432	810
438	820
443	830
449	840
454	850
460	860
466	870
471	880
477	890
482	900
488	910
493	920
499	930
504	940
510	950
516	960
521	970
527	980
532	990
538	1000
549	1020
560	1040
571	1060
582	1080
593	1100
604	1120
616	1140
627	1160
638	1180
649	1200

Custom Groove Dimensions

Contents

Piston Gland..... C-1
Rod Seal and Rod Wiper..... C-2
Piston Wear Ring..... C-2
Rod Wear Ring C-3

There are times when using standard seal groove dimensions is not an option. Whether it is for cylinders that have been refinished or off sized metal, there are some simple calculations to use to determine what the appropriate groove dimensions should be. The formulas for calculating custom groove dimensions are included below.



Piston Gland Custom Groove Calculation

Subtract the standard bore diameter from the next smallest standard bore diameter to determine the Offset Factor. Apply the Offset Factor to the Groove Diameter, X , and the Shoulder Diameter, Y , as shown below. Groove Width, Z , will remain unchanged.

Offset Factor Diameter:

$$\left(\begin{array}{c} \text{Offset} \\ \text{Factor} \end{array} \right) = \left(\begin{array}{c} \text{Required} \\ \text{Bore Diameter} \end{array} \right) - \left(\begin{array}{c} \text{Standard} \\ \text{Bore Diameter} \end{array} \right)$$

New Groove Diameter, X :

$$X = \left(\begin{array}{c} \text{Standard} \\ \text{Groove Diameter} \end{array} \right) + \left(\begin{array}{c} \text{Offset} \\ \text{Factor} \end{array} \right)$$

New Piston Diameter, Y :

$$Y = \left(\begin{array}{c} \text{Standard} \\ \text{Piston Diameter} \end{array} \right) + \left(\begin{array}{c} \text{Offset} \\ \text{Factor} \end{array} \right)$$

If the required diameter is smaller than the standard diameter, a negative Offset Factor will be calculated, and the piston seal will be compressed. In most circumstances, Parker advises against compressing smaller sizes of piston seals to fit oversized bores. Please contact your local Parker representative for assistance in these cases.

IMPORTANT: It is necessary to calculate the additional stretch that the piston seal will be subjected to. Do this by using the equation below:

$$\left(\begin{array}{c} \text{Additional} \\ \text{Stretch \%} \end{array} \right) = \left(\frac{\text{Offset Factor}}{\text{Standard Bore Diameter}} \right) \times 100$$

Parker recommends that the Additional Stretch Percentage not exceed 5%. If this percentage does exceed 5%, please contact your local Parker representative for assistance.

Rod Seal and Rod Wiper Custom Groove Calculation

Catalog EPS 5370/USA

Subtract the required rod diameter from the next largest standard rod diameter to determine the Offset Factor. Apply the Offset Factor to the Groove Diameter, X , and the Throat Diameter, Y , as shown below. Groove Width, Z , will remain unchanged.

Offset Factor Diameter

$$\left(\begin{array}{c} \text{Offset} \\ \text{Factor} \end{array} \right) = \left(\begin{array}{c} \text{Standard} \\ \text{Rod Diameter} \end{array} \right) - \left(\begin{array}{c} \text{Required} \\ \text{Rod Diameter} \end{array} \right)$$

New Groove Diameter, X :

$$X = \left(\begin{array}{c} \text{Standard} \\ \text{Groove Diameter} \end{array} \right) - \left(\begin{array}{c} \text{Offset} \\ \text{Factor} \end{array} \right)$$

New Shoulder Diameter, Y :

$$Y = \left(\begin{array}{c} \text{Standard} \\ \text{Shoulder Diameter} \end{array} \right) - \left(\begin{array}{c} \text{Offset} \\ \text{Factor} \end{array} \right)$$

If the required diameter is larger than the standard diameter, a negative Offset Factor will be calculated, and the rod seal will be stretched. In most circumstances, Parker advises against stretching smaller sizes of rod seals to fit oversized rods.

Please contact your local Parker representative for assistance in these cases.

IMPORTANT: It is necessary to calculate the additional compression that the rod seal will be subjected to. Do this by using the equation below:

$$\left(\begin{array}{c} \text{Additional} \\ \text{Compression \%} \end{array} \right) = \left(\frac{\text{Offset Factor}}{\text{Standard Bore Diameter}} \right) \times 100$$

Parker recommends that the Additional Compression Percentage not exceed 2%. If this percentage does exceed 2%, please contact your local Parker representative for assistance.

Piston Wear Ring Groove Calculation

The formula for calculating piston wear ring grooves using alternative extrusion gaps, metal-to-metal clearances and machining tolerances:

1. Maximum Groove Diameter, B :

$$B = \left[\left(\begin{array}{c} \text{Minimum Bore} \\ \text{Diameter, A} \end{array} \right) - .001'' \right] - 2 \times \left(\begin{array}{c} \text{Max. Cross} \\ \text{Section} \end{array} \right)$$

2. Minimum Groove Diameter:

$$\left(\begin{array}{c} \text{Minimum} \\ \text{Groove Diameter} \end{array} \right) = B - \left(\begin{array}{c} \text{Machining} \\ \text{Tolerances} \end{array} \right)$$

3. Maximum Piston Diameter, C :

$$C = \left(\begin{array}{c} \text{Min. Groove} \\ \text{Diameter} \end{array} \right) + 2 \times \left(\begin{array}{c} \text{Min. Cross} \\ \text{Section} \end{array} \right) - 2 \times \left(\begin{array}{c} \text{Desired Min. Radial} \\ \text{Metal-to-Metal Clearance} \end{array} \right)$$

4. $D = (\text{Nominal Width, } W) + .010''$

$$D = \left(\begin{array}{c} \text{Nominal Width, } W \end{array} \right) + \left(.010'' \right)$$

Notes:

1. Tolerance for dimension D is $+.010'' / -.000''$
2. Groove radii must not exceed $.015''$ max.
3. Parker recommends a minimum $.005''$ radial metal-to-metal clearance. Using the above equations may result in metal-to-metal contact if the material's compressive properties are not considered, contact your local Parker representative for assistance.

06/01/2014

Rod Wear Ring Groove Calculation

The formula for calculating rod wear ring grooves using alternative extrusion gaps metal-to-metal clearances and machining tolerances:

1. Maximum Groove Diameter, **BI**:

$$BI = \left[\left(\text{Minimum Rod Diameter, } A \right) - .001'' \right] - 2 \times \left(\text{Max. Cross Section} \right)$$

2. Maximum Groove Diameter:

$$\left(\text{Minimum Groove Diameter} \right) = BI + \left(\text{Machining Tolerances} \right)$$

3. Minimum Throat Diameter, **CI**:

$$CI = \left(\text{Max. Groove Diameter} \right) - 2 \times \left(\text{Min. Cross Section} \right) + 2 \times \left(\text{Desired Min. Radial Metal-to-Metal Clearance} \right)$$

4. **D** = (Nominal Width, **W**) + .010"

$$D = \left(\text{Nominal Width, } W \right) + \left(.010'' \right)$$

Notes:

1. Tolerance for dimension **D** is +.010" / -.000"
2. Groove radii must not exceed .015" max.
3. Parker recommends a minimum .005" radial metal-to-metal clearance. Using the above equations may result in metal-to-metal contact if the material's compressive properties are not considered, contact your local Parker representative for assistance.

AN6226 Gland Dimensions & Tolerances (Army/Navy)

Gland Dimensions — AN6226 Profile

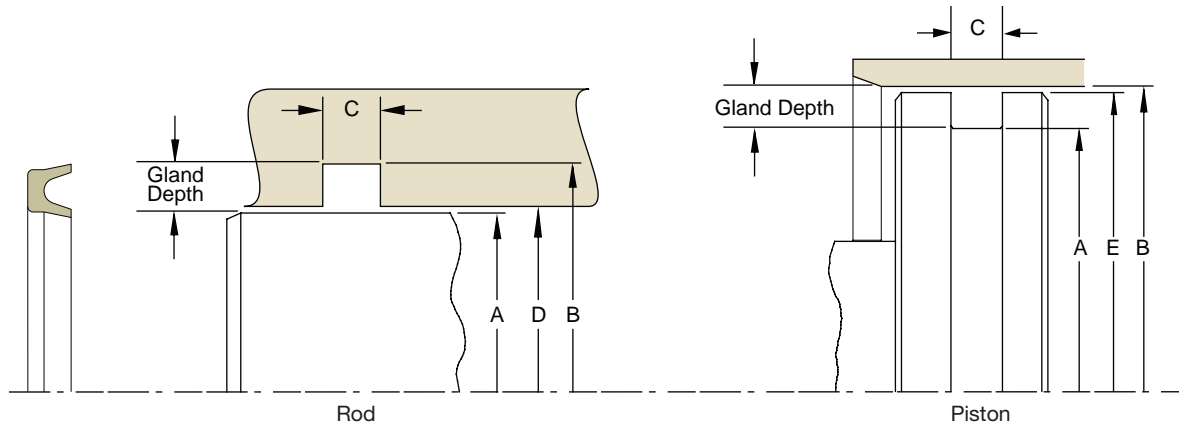

Table D-1A. Rod Gland Dimension Tolerances

Nominal Gland Depth	A Rod Diameter	B Groove Diameter	C Groove Width	D Throat Diameter
1/8	+0.000/-0.001	+0.002/-0.000	+0.010/-0.010	+0.002/-0.000
3/16	+0.000/-0.001	+0.002/-0.000		+0.002/-0.000
1/4	+0.000/-0.002	+0.003/-0.000		+0.003/-0.000
5/16	+0.000/-0.002	+0.004/-0.000		+0.004/-0.000
3/8	+0.000/-0.002	+0.005/-0.000		+0.004/-0.000
				+0.004/-0.000

Table D-1B. Piston Gland Dimension Tolerances

Nominal Gland Depth	B Bore Diameter	A Groove Diameter	C Groove Width	E Piston Diameter
1/8	+0.003/-0.000	+0.000/-0.001	+0.010/-0.010	+0.000/-0.001
3/16	+0.003/-0.000	+0.000/-0.002		+0.000/-0.001
1/4	+0.003/-0.000	+0.000/-0.003		+0.000/-0.001
5/16	+0.003/-0.000	+0.000/-0.004		+0.000/-0.002
3/8	+0.004/-0.000	+0.000/-0.005		+0.000/-0.002
				+0.000/-0.002

Please refer to Engineering Section 2, page 2-8 for surface finish and additional hardware considerations.

Table D-2. AN6226 Gland Dimensions — Inch

A	B	C	D	E	Part Number
Rod Diameter	(Rod) Groove Diameter	(Rod) Groove Width	Throat Diameter*	(Bore) Piston Diameter**	
(Bore) Groove Diameter	Bore Diameter	(Bore) Groove Width			
0.125	0.500	0.218	0.126	0.498	42956226-01
0.187	0.562	0.218	0.188	0.560	42956226-02
0.250	0.625	0.218	0.251	0.623	42956226-03
0.312	0.687	0.218	0.313	0.685	42956226-04
0.375	0.750	0.218	0.376	0.748	42956226-05
0.437	0.812	0.218	0.438	0.810	42956226-06

*If used with wear rings, refer to wear ring throat diameter, see Section 9.

**If used with wear rings, refer to wear ring piston diameter, see Section 9.

For custom groove calculations, see Appendix C.

Part numbers shown as example only. Consult www.parker.com/eps/FluidPower for part number availability. Contact your Parker representative for assistance.

Table D-2. AN6226 Gland Dimensions – Inch (Continued)

A	B	C	D	E	Part Number
Rod Diameter	(Rod) Groove Diameter	(Rod) Groove Width	Throat Diameter*	(Bore) Piston Diameter**	
(Bore) Groove Diameter	Bore Diameter	(Bore) Groove Width			
0.500	0.875	0.218	0.501	0.873	42956226-07
0.250	0.750	0.281	0.251	0.748	42956226-08
0.312	0.812	0.281	0.313	0.810	42956226-09
0.375	0.875	0.281	0.376	0.873	42956226-10
0.437	0.937	0.281	0.438	0.935	42956226-11
0.500	1.000	0.281	0.501	0.998	42956226-12
0.562	1.062	0.281	0.563	1.060	42956226-13
0.625	1.125	0.281	0.626	1.123	42956226-14
0.687	1.187	0.281	0.688	1.185	42956226-15
0.750	1.250	0.281	0.751	1.248	42956226-16
0.812	1.312	0.281	0.813	1.310	42956226-17
0.875	1.375	0.281	0.876	1.373	42956226-18
0.937	1.437	0.281	0.938	1.435	42956226-19
1.000	1.500	0.281	1.001	1.498	42956226-20
1.062	1.562	0.281	1.063	1.560	42956226-21
1.125	1.625	0.281	1.126	1.623	42956226-22
1.187	1.687	0.281	1.188	1.685	42956226-23
1.250	1.750	0.281	1.251	1.748	42956226-24
1.250	1.875	0.344	1.252	1.873	42956226-25
1.375	2.000	0.344	1.377	1.998	42956226-26
1.500	2.125	0.344	1.502	2.123	42956226-27
1.625	2.250	0.344	1.627	2.248	42956226-28
1.750	2.375	0.344	1.752	2.373	42956226-29
1.875	2.500	0.344	1.877	2.498	42956226-30
2.000	2.625	0.344	2.002	2.623	42956226-31
2.125	2.750	0.344	2.127	2.748	42956226-32
2.250	2.875	0.344	2.252	2.873	42956226-33
2.375	3.000	0.344	2.377	2.998	42956226-34
2.500	3.125	0.344	2.502	3.123	42956226-35
2.500	3.250	0.406	2.502	3.248	42956226-36
2.625	3.375	0.406	2.627	3.373	42956226-37
2.750	3.500	0.406	2.752	3.498	42956226-38
2.875	3.625	0.406	2.877	3.623	42956226-39
3.000	3.750	0.406	3.002	3.748	42956226-40

*If used with wear rings, refer to wear ring throat diameter, see [Section 9](#).

**If used with wear rings, refer to wear ring piston diameter, see [Section 9](#).

For custom groove calculations, see [Appendix C](#).

Part numbers shown as example only. Consult www.parker.com/eps/FluidPower for part number availability. Contact your Parker representative for assistance.

Table D-2. AN6226 Gland Dimensions – Inch (Continued)

A	B	C		D	E	Part Number
		(Rod) Groove Diameter	(Rod) Groove Width			
(Bore) Groove Diameter	Bore Diameter	(Bore) Groove Diameter	(Bore) Groove Width			
0.125	0.375	0.156	0.156	0.126	0.373	42956226-41
0.187	0.437	0.156	0.156	0.188	0.435	42956226-42
0.250	0.500	0.156	0.156	0.251	0.498	42956226-43
0.312	0.562	0.156	0.156	0.313	0.560	42956226-44
0.375	0.625	0.156	0.156	0.376	0.623	42956226-45
0.437	0.687	0.156	0.156	0.438	0.685	42956226-46
0.500	0.750	0.156	0.156	0.501	0.748	42956226-47
0.625	1.000	0.218	0.218	0.626	0.998	42956226-48
0.750	1.125	0.218	0.218	0.751	1.123	42956226-49
0.875	1.250	0.218	0.218	0.876	1.248	42956226-50
1.000	1.375	0.218	0.218	1.001	1.373	42956226-51
1.125	1.500	0.218	0.218	1.126	1.498	42956226-52
1.250	1.625	0.218	0.218	1.251	1.623	42956226-53

*If used with wear rings, refer to wear ring throat diameter, see Section 9.

**If used with wear rings, refer to wear ring piston diameter, see Section 9.

For custom groove calculations, see Appendix C.

Part numbers shown as example only. Consult www.parker.com/eps/FluidPower for part number availability. Contact your Parker representative for assistance.

MS-28776 (MS-33675) Dash Size Grooves (for SH959 Profile Wipers)

Gland Dimensions

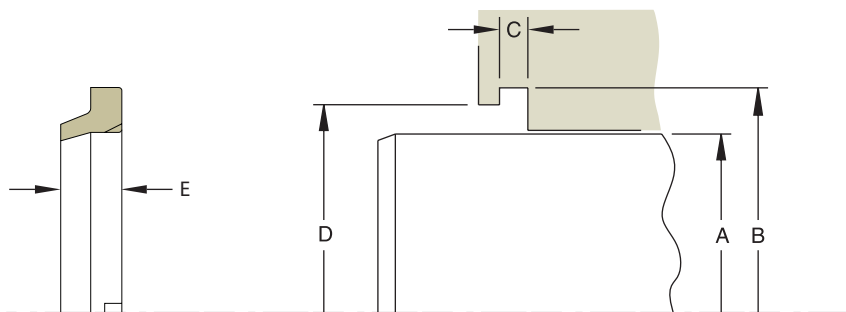

Please refer to Engineering [Section 2, page 2-8](#) for surface finish and additional hardware considerations.



Table E-1. Gland Dimensions – Inch

Dash Size	A Rod Diameter	B Groove Diameter	C Groove Width	D Shoulder Diameter	E Max. Wiper Axial Width	Example Part Number		
						Compound Code	Profile & Dash Size	
	+0.000/-0.002	+0.004/-0.000	+0.003/-0.003	+0.005/-0.000				
-1	0.500	0.760	0.107	0.647	0.187	XXXX	SH	959-01
-2	0.562	0.823	0.107	0.710	0.187	XXXX	SH	959-02
-3	0.625	0.885	0.107	0.772	0.187	XXXX	SH	959-03
-4	0.687	0.948	0.107	0.834	0.187	XXXX	SH	959-04
-5	0.750	1.010	0.107	0.897	0.187	XXXX	SH	959-05
-6	0.812	1.084	0.107	0.960	0.187	XXXX	SH	959-06
-7	0.875	1.147	0.107	1.023	0.187	XXXX	SH	959-07
-9	1.000	1.272	0.107	1.148	0.187	XXXX	SH	959-09
-10	1.062	1.334	0.107	1.210	0.187	XXXX	SH	959-10
-11	1.125	1.397	0.107	1.273	0.187	XXXX	SH	959-11
-12	1.187	1.459	0.107	1.335	0.187	XXXX	SH	959-12
-13	1.250	1.522	0.107	1.398	0.187	XXXX	SH	959-13
-14	1.312	1.614	0.107	1.480	0.187	XXXX	SH	959-14
-15	1.375	1.677	0.107	1.542	0.187	XXXX	SH	959-15
-16	1.437	1.739	0.107	1.605	0.187	XXXX	SH	959-16
-17	1.500	1.802	0.107	1.668	0.187	XXXX	SH	959-17
-M	1.562	1.865	0.107	1.731	0.187	XXXX	SH	959-M
-18	1.625	1.927	0.107	1.793	0.187	XXXX	SH	959-18
-19	1.750	2.052	0.107	1.918	0.187	XXXX	SH	959-19
-A	1.812	2.115	0.107	1.981	0.187	XXXX	SH	959-A
-20	1.875	2.117	0.107	2.043	0.187	XXXX	SH	959-20
-21	2.000	2.302	0.107	2.178	0.187	XXXX	SH	959-21

For custom groove calculations, see [Appendix C](#).

Table E-1. Gland Dimensions — Inch (Continued)

Dash Size	A Rod Diameter	B Groove Diameter	C Groove Width	D Shoulder Diameter	E Max. Wiper Axial Width	Example Part Number		
						Compound Code	Profile & Dash Size	
	+ .000/- .003	+ .004/- .000	+ .003/- .003	+ .005/- .000				
-22	2.125	2.427	0.107	2.303	0.187	XXXX	SH	959-22
-23	2.250	2.552	0.107	2.428	0.187	XXXX	SH	959-23
-24	2.375	2.677	0.107	2.553	0.187	XXXX	SH	959-24
-25	2.500	2.802	0.107	2.678	0.187	XXXX	SH	959-25
	+ .000/- .003	+ .004/- .000	+ .003/- .003	+ .005/- .000				
-26	2.625	2.989	0.122	2.834	0.211	XXXX	SH	959-26
-27	2.750	3.114	0.122	2.959	0.211	XXXX	SH	959-27
-28	2.875	3.239	0.122	3.084	0.211	XXXX	SH	959-28
-29	3.000	3.364	0.122	3.209	0.211	XXXX	SH	959-29
-30	3.125	3.489	0.122	3.334	0.211	XXXX	SH	959-30
-31	3.250	3.614	0.122	3.459	0.211	XXXX	SH	959-31
-32	3.375	3.739	0.122	3.584	0.211	XXXX	SH	959-32
-33	3.500	3.864	0.122	3.709	0.211	XXXX	SH	959-33
-34	3.625	3.989	0.122	3.834	0.211	XXXX	SH	959-34
-35	3.750	4.114	0.122	3.959	0.211	XXXX	SH	959-35
-36	3.875	4.239	0.122	4.084	0.211	XXXX	SH	959-36
-37	4.000	4.427	0.138	4.240	0.238	XXXX	SH	959-37
-38	4.125	4.552	0.138	4.365	0.238	XXXX	SH	959-38
-39	4.250	4.677	0.138	4.490	0.238	XXXX	SH	959-39
-41	4.500	4.927	0.138	4.740	0.238	XXXX	SH	959-41
-42	4.625	5.052	0.138	4.865	0.238	XXXX	SH	959-42
-43	4.750	5.177	0.138	4.990	0.238	XXXX	SH	959-43
-45	5.000	5.427	0.138	5.240	0.238	XXXX	SH	959-45
-47	5.250	5.677	0.138	5.490	0.238	XXXX	SH	959-47
-49	5.500	5.927	0.138	5.740	0.238	XXXX	SH	959-49
-51	5.750	6.239	0.154	6.022	0.264	XXXX	SH	959-51
-53	6.000	6.489	0.154	6.272	0.264	XXXX	SH	959-53
	+ .000/- .004	+ .005/- .000	+ .003/- .003	+ .005/- .000				
-55	6.500	6.989	0.154	6.772	0.264	XXXX	SH	959-55
-56	6.750	7.239	0.154	7.022	0.264	XXXX	SH	959-56
-57	7.000	7.489	0.154	7.272	0.264	XXXX	SH	959-57
-L	7.375	7.864	0.154	7.647	0.264	XXXX	SH	959-L
-59	7.500	7.989	0.154	7.772	0.264	XXXX	SH	959-59
-62	8.500	8.989	0.154	8.772	0.264	XXXX	SH	959-62
	+ .000/- .005	+ .005/- .000	+ .003/- .003	+ .010/- .000				
-63	9.000	9.489	0.154	9.272	0.264	XXXX	SH	959-63
-64	9.500	9.989	0.154	9.772	0.264	XXXX	SH	959-64
-65	10.000	10.489	0.154	10.272	0.264	XXXX	SH	959-65
-66	10.500	10.989	0.154	10.772	0.264	XXXX	SH	959-66
-FF	11.250	11.739	0.169	11.522	0.289	XXXX	SH	959-FF
-68	11.500	11.989	0.169	11.772	0.289	XXXX	SH	959-68
-69	12.000	12.489	0.169	12.272	0.289	XXXX	SH	959-69
-70	12.500	12.989	0.169	12.772	0.289	XXXX	SH	959-70
-K	13.750	14.239	0.169	14.022	0.289	XXXX	SH	959-K
-77	14.000	14.489	0.169	14.272	0.289	XXXX	SH	959-77
-Q	14.250	14.739	0.169	14.522	0.289	XXXX	SH	959-Q

For custom groove calculations, see [Appendix C](#).

NOTE: For sizes larger than those shown in the table, please contact your local Parker Seal representative.

Commercial PTFE Back-up Ring Dimensions

Catalog EPS 5370/USA

Commercial PTFE Back-up Ring Dimensions per MS28774

Part Dimensions — PDBA Profile, Split Ring

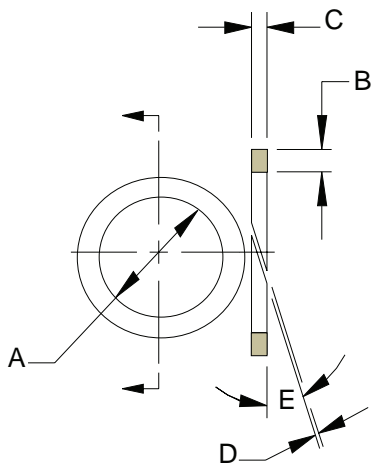

Please refer to Engineering [Section 2, page 2-8](#) for surface finish and additional hardware considerations.



Table F-1. PDBA Dimensions, Split Ring

Dash # MS 28774	Seal Dimensions				
	A Inside Dia.	B Radial Cross- Section	C Width	D Split Gap	E Split Angle Degree
	+.001/ -.001				
004	0.109	.052/.054	.045/.052	.000/.005	39
005	0.124	.052/.054	.045/.052	.000/.005	33
006	0.140	.052/.054	.045/.052	.000/.005	30
007	0.171	.052/.054	.045/.052	.000/.005	26
008	0.202	.052/.054	.045/.052	.000/.005	22
009	0.234	.052/.054	.045/.052	.000/.005	22
010	0.265	.052/.054	.045/.052	.000/.005	22
011	0.327	.052/.054	.045/.052	.000/.005	22
012	0.390	.052/.054	.045/.052	.000/.005	22
013	0.455	.052/.054	.045/.052	.000/.005	22
014	0.518	.052/.054	.045/.052	.000/.005	22
015	0.580	.052/.054	.045/.052	.000/.005	22
016	0.643	.052/.054	.045/.052	.000/.005	22
017	0.705	.052/.054	.045/.052	.000/.005	22
018	0.768	.052/.054	.045/.052	.000/.005	22
019	0.830	.052/.054	.045/.052	.000/.005	22
020	0.898	.052/.054	.045/.052	.000/.005	22
021	0.960	.052/.054	.045/.052	.000/.005	22
022	1.023	.052/.054	.045/.052	.000/.005	22
023	1.085	.052/.054	.045/.052	.000/.005	22

Dash # MS 28774	Seal Dimensions				
	A Inside Dia.	B Radial Cross- Section	C Width	D Split Gap	E Split Angle Degree
	+.001/ -.001				
024	1.148	.052/.054	.045/.052	.000/.005	22
025	1.210	.052/.054	.045/.052	.000/.005	22
026	1.273	.052/.054	.045/.052	.000/.005	22
027	1.335	.052/.054	.045/.052	.000/.005	22
028	1.398	.052/.054	.045/.052	.000/.005	22
110	0.390	.085/.087	.045/.052	.000/.006	22
111	0.452	.085/.087	.045/.052	.000/.006	22
112	0.515	.085/.087	.045/.052	.000/.006	22
113	0.577	.085/.087	.045/.052	.000/.006	22
114	0.640	.085/.087	.045/.052	.000/.006	22
115	0.702	.085/.087	.045/.052	.000/.006	22
116	0.765	.085/.087	.045/.052	.000/.006	22
117	0.832	.085/.087	.045/.052	.000/.006	22
118	0.895	.085/.087	.045/.052	.000/.006	22
119	0.957	.085/.087	.045/.052	.000/.006	22
120	1.020	.085/.087	.045/.052	.000/.006	22
121	1.082	.085/.087	.045/.052	.000/.006	22
122	1.145	.085/.087	.045/.052	.000/.006	22
123	1.207	.085/.087	.045/.052	.000/.006	22
124	1.270	.085/.087	.045/.052	.000/.006	22

NOTE: Measure Split Gap using a Mandrel with "A" Diameter.

06/01/2014

Table F-1. PDBA Dimensions, Split Ring (cont'd)

Dash # MS 28774	Seal Dimensions				
	A Inside Dia.	B Radial Cross- Section	C Width	D Split Gap	E Split Angle Degree
	+.001/ -.001				
125	1.332	.085/.087	.045/.052	.000/.006	22
126	1.397	.085/.087	.045/.052	.000/.006	22
127	1.459	.085/.087	.045/.052	.000/.006	22
128	1.522	.085/.087	.045/.052	.000/.006	22
129	1.584	.085/.087	.045/.052	.000/.006	22
130	1.647	.085/.087	.045/.052	.000/.006	22
131	1.709	.085/.087	.045/.052	.000/.006	22
132	1.772	.085/.087	.045/.052	.000/.006	22
133	1.934	.085/.087	.045/.052	.000/.006	22
134	1.897	.085/.087	.045/.052	.000/.006	22
135	1.959	.085/.087	.045/.052	.000/.006	22
136	2.022	.085/.087	.045/.052	.000/.006	22
137	2.084	.085/.087	.045/.052	.000/.006	22
138	2.147	.085/.087	.045/.052	.000/.006	22
139	2.209	.085/.087	.045/.052	.000/.006	22
140	2.258	.085/.087	.045/.052	.000/.006	22
141	2.320	.085/.087	.045/.052	.000/.006	22
142	2.383	.085/.087	.045/.052	.000/.006	22
143	2.445	.085/.087	.045/.052	.000/.006	22
144	2.508	.085/.087	.045/.052	.000/.006	22
145	2.570	.085/.087	.045/.052	.000/.006	22
146	2.633	.085/.087	.045/.052	.000/.006	22
147	2.695	.085/.087	.045/.052	.000/.006	22
148	2.758	.085/.087	.045/.052	.000/.006	22
149	2.820	.085/.087	.045/.052	.000/.006	22
210	0.766	.118/.120	.045/.052	.000/.006	22
211	0.828	.118/.120	.045/.052	.000/.006	22
212	0.891	.118/.120	.045/.052	.000/.006	22
213	0.953	.118/.120	.045/.052	.000/.006	22
214	1.016	.118/.120	.045/.052	.000/.006	22
215	1.078	.118/.120	.045/.052	.000/.006	22
216	1.141	.118/.120	.045/.052	.000/.006	22
217	1.203	.118/.120	.045/.052	.000/.006	22
218	1.266	.118/.120	.045/.052	.000/.006	22
219	1.344	.118/.120	.045/.052	.000/.006	22
220	1.397	.118/.120	.045/.052	.000/.006	22
221	1.459	.118/.120	.045/.052	.000/.006	22
222	1.522	.118/.120	.045/.052	.000/.006	22
223	1.647	.118/.120	.045/.052	.000/.007	22
224	1.772	.118/.120	.045/.052	.000/.007	22
225	1.897	.118/.120	.045/.052	.000/.007	22
226	2.022	.118/.120	.045/.052	.000/.007	22
227	2.147	.118/.120	.045/.052	.000/.007	22
228	2.272	.118/.120	.045/.052	.000/.007	22
229	2.397	.118/.120	.045/.052	.000/.007	22
230	2.522	.118/.120	.045/.052	.000/.007	22
231	2.631	.118/.120	.045/.052	.000/.007	22
232	2.756	.118/.120	.045/.052	.000/.007	22

Dash # MS 28774	Seal Dimensions				
	A Inside Dia.	B Radial Cross- Section	C Width	D Split Gap	E Split Angle Degree
	+.001/ -.001				
233	2.881	.118/.120	.045/.052	.000/.007	22
234	3.006	.118/.120	.045/.052	.000/.007	22
235	3.131	.118/.120	.045/.052	.000/.007	22
236	3.256	.118/.120	.045/.052	.000/.007	22
237	3.381	.118/.120	.045/.052	.000/.007	22
238	3.506	.118/.120	.045/.052	.000/.007	22
239	3.631	.118/.120	.045/.052	.000/.007	22
240	3.756	.118/.120	.045/.052	.000/.007	22
241	3.881	.118/.120	.045/.052	.000/.007	22
242	4.006	.118/.120	.045/.052	.000/.007	22
243	4.131	.118/.120	.045/.052	.000/.007	22
244	4.256	.118/.120	.045/.052	.000/.007	22
245	4.381	.118/.120	.045/.052	.000/.007	22
246	4.506	.118/.120	.045/.052	.000/.007	22
247	4.631	.118/.120	.045/.052	.000/.007	22
325	1.513	.182/.184	.065/.075	.000/.007	22
326	1.638	.182/.184	.065/.075	.000/.007	22
327	1.763	.182/.184	.065/.075	.000/.007	22
328	1.888	.182/.184	.065/.075	.000/.007	22
329	2.013	.182/.184	.065/.075	.000/.007	22
330	2.138	.182/.184	.065/.075	.000/.007	22
331	2.268	.182/.184	.065/.075	.000/.007	22
332	2.393	.182/.184	.065/.075	.000/.007	22
333	2.518	.182/.184	.065/.075	.000/.007	22
334	2.643	.182/.184	.065/.075	.000/.007	22
335	2.768	.182/.184	.065/.075	.000/.007	22
336	2.893	.182/.184	.065/.075	.000/.007	22
337	3.018	.182/.184	.065/.075	.000/.007	22
338	3.143	.182/.184	.065/.075	.000/.007	22
339	3.273	.182/.184	.065/.075	.000/.007	22
340	3.398	.182/.184	.065/.075	.000/.007	22
341	3.523	.182/.184	.065/.075	.000/.007	22
342	3.648	.182/.184	.065/.075	.000/.007	22
343	3.773	.182/.184	.065/.075	.000/.007	22
344	3.898	.182/.184	.065/.075	.000/.007	22
345	4.028	.182/.184	.065/.075	.000/.007	22
346	4.153	.182/.184	.065/.075	.000/.007	22
347	4.278	.182/.184	.065/.075	.000/.007	22
348	4.403	.182/.184	.065/.075	.000/.007	22
349	4.528	.182/.184	.065/.075	.000/.007	22
425	4.551	.235/.237	.106/.110	.000/.008	22
426	4.676	.235/.237	.106/.110	.000/.008	22
427	4.801	.235/.237	.106/.110	.000/.008	22
428	4.926	.235/.237	.106/.110	.000/.008	22
429	5.051	.235/.237	.106/.110	.000/.008	22
430	5.176	.235/.237	.106/.110	.000/.008	22
431	5.301	.235/.237	.106/.110	.000/.008	22
432	5.426	.235/.237	.106/.110	.000/.008	22

NOTE: Measure Split Gap using a Mandrel with "A" Diameter.

Table F-1. PDBA Dimensions, Split Ring (cont'd)

Dash # MS 28774	Seal Dimensions				
	A Inside Dia.	B Radial Cross- Section	C Width	D Split Gap	E Split Angle Degree
	+0.01/ -.001				
433	5.551	.235/.237	.106/.110	.000/.008	22
434	5.676	.235/.237	.106/.110	.000/.008	22
435	5.801	.235/.237	.106/.110	.000/.008	22
436	5.926	.235/.237	.106/.110	.000/.008	22
437	6.051	.235/.237	.106/.110	.000/.008	22
438	6.274	.235/.237	.106/.110	.000/.008	22
439	6.524	.235/.237	.106/.110	.000/.008	22
440	6.774	.235/.237	.106/.110	.000/.008	22
441	7.024	.235/.237	.106/.110	.000/.008	22
442	7.274	.235/.237	.106/.110	.000/.008	22
443	7.524	.235/.237	.106/.110	.000/.008	22
444	7.774	.235/.237	.106/.110	.000/.008	22
445	8.024	.235/.237	.106/.110	.000/.008	22
446	8.524	.235/.237	.106/.110	.000/.008	22
447	9.024	.235/.237	.106/.110	.000/.008	22
448	9.524	.235/.237	.106/.110	.000/.008	22
449	10.024	.235/.237	.106/.110	.000/.008	22
450	10.524	.235/.237	.106/.110	.000/.008	22
451	11.024	.235/.237	.106/.110	.000/.008	22
452	11.524	.235/.237	.106/.110	.000/.008	22
453	12.024	.235/.237	.106/.110	.000/.008	22
454	12.524	.235/.237	.106/.110	.000/.008	22
455	13.024	.235/.237	.106/.110	.000/.008	22
456	13.524	.235/.237	.106/.110	.000/.008	22
457	14.024	.235/.237	.106/.110	.000/.008	22
458	14.524	.235/.237	.106/.110	.000/.008	22
459	15.024	.235/.237	.106/.110	.000/.008	22
460	15.524	.235/.237	.106/.110	.000/.008	22

NOTE: Measure Split Gap using a Mandrel with "A" Diameter.

NOTE: For sizes larger than those shown in the table, please contact your local Parker Seal representative.

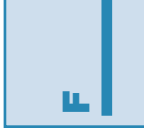

Commercial PTFE Back-up Ring Dimensions per MS27595

Dimensions – PDBB Profile, Solid Ring

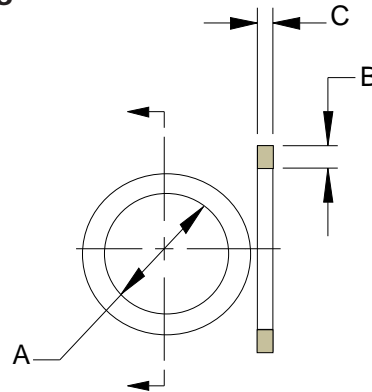

Please refer to Engineering [Section 2, page 2-8](#) for surface finish and additional hardware considerations.

Table F-2. PDBB Dimensions, Solid Ring

Dash Number MS27595	Seal Dimensions		
	A I.D.	B Radial Cross- Section	C Width
	+.001/ -.000		
004	0.080	.048/.052	.054/.056
005	0.111	.048/.052	.054/.056
006	0.125	.048/.052	.054/.056
007	0.156	.048/.052	.054/.056
008	0.187	.048/.052	.054/.056
009	0.219	.048/.052	.054/.056
010	0.250	.048/.052	.054/.056
011	0.312	.048/.052	.054/.056
012	0.375	.048/.052	.054/.056
013	0.440	.048/.052	.054/.056
014	0.503	.048/.052	.054/.056
015	0.565	.048/.052	.054/.056
016	0.628	.048/.052	.054/.056
017	0.690	.048/.052	.054/.056
018	0.753	.048/.052	.054/.056
019	0.815	.048/.052	.054/.056
020	0.881	.048/.052	.054/.056
	+.002/ -.002		
021	0.943	.048/.052	.054/.056
022	1.006	.048/.052	.054/.056
023	1.068	.048/.052	.054/.056
024	1.131	.048/.052	.054/.056
025	1.193	.048/.052	.054/.056
026	1.256	.048/.052	.054/.056
027	1.318	.048/.052	.054/.056
028	1.381	.048/.052	.054/.056
	+.001/ -.002		
110	0.374	.048/.052	.087/.089
111	0.437	.048/.052	.087/.089
112	0.499	.048/.052	.087/.089
113	0.562	.048/.052	.087/.089
114	0.624	.048/.052	.087/.089
115	0.687	.048/.052	.087/.089

Dash Number MS27595	Seal Dimensions		
	A I.D.	B Radial Cross- Section	C Width
	+.001/ -.002		
116	0.749	.048/.052	.087/.089
117	0.815	.048/.052	.087/.089
118	0.877	.048/.052	.087/.089
119	0.940	.048/.052	.087/.089
120	1.002	.048/.052	.087/.089
	+.002/ -.002		
121	1.065	.048/.052	.087/.089
122	1.127	.048/.052	.087/.089
123	1.190	.048/.052	.087/.089
124	1.252	.048/.052	.087/.089
125	1.315	.048/.052	.087/.089
126	1.377	.048/.052	.087/.089
127	1.440	.048/.052	.087/.089
128	1.502	.048/.052	.087/.089
129	1.565	.048/.052	.087/.089
130	1.629	.048/.052	.087/.089
131	1.691	.048/.052	.087/.089
132	1.754	.048/.052	.087/.089
133	1.816	.048/.052	.087/.089
134	1.879	.048/.052	.087/.089
135	1.942	.048/.052	.087/.089
136	2.004	.048/.052	.087/.089
137	2.067	.048/.052	.087/.089
138	2.129	.048/.052	.087/.089
139	2.192	.048/.052	.087/.089
140	2.254	.048/.052	.087/.089
141	2.317	.048/.052	.087/.089
142	2.379	.048/.052	.087/.089
143	2.442	.048/.052	.087/.089
144	2.504	.048/.052	.087/.089
145	2.567	.048/.052	.087/.089
146	2.629	.048/.052	.087/.089
147	2.692	.048/.052	.087/.089

Dash Number MS27595	Seal Dimensions		
	A I.D.	B Radial Cross- Section	C Width
	+.002/ -.002		
148	2.754	.048/.052	.087/.089
149	2.817	.048/.052	.087/.089
	+.001/ -.002		
210	0.753	.048/.052	.118/.120
211	0.815	.048/.052	.118/.120
212	0.878	.048/.052	.118/.120
213	0.940	.048/.052	.118/.120
214	1.003	.048/.052	.118/.120
215	1.065	.048/.052	.118/.120
216	1.128	.048/.052	.118/.120
217	1.190	.048/.052	.118/.120
218	1.253	.048/.052	.118/.120
219	1.315	.048/.052	.118/.120
220	1.378	.048/.052	.118/.120
221	1.440	.048/.052	.118/.120
222	1.503	.048/.052	.118/.120
223	1.629	.048/.052	.118/.120
224	1.754	.048/.052	.118/.120
225	1.880	.048/.052	.118/.120
226	2.005	.048/.052	.118/.120
227	2.130	.048/.052	.118/.120
228	2.255	.048/.052	.118/.120
229	2.380	.048/.052	.118/.120
230	2.505	.048/.052	.118/.120
231	2.630	.048/.052	.118/.120
232	2.755	.048/.052	.118/.120
233	2.880	.048/.052	.118/.120
234	3.005	.048/.052	.118/.120
235	3.130	.048/.052	.118/.120
236	3.255	.048/.052	.118/.120
237	3.380	.048/.052	.118/.120
238	3.505	.048/.052	.118/.120
239	3.630	.048/.052	.118/.120

06/01/2014

Table F-2. PDBB Dimensions, Solid Ring (cont'd)

Dash Number MS27595	Seal Dimensions		
	A I.D.	B Radial Cross-Section	C Width
	+ .001/ - .002		
240	3.755	.048/.052	.118/.120
241	3.880	.048/.052	.118/.120
242	4.005	.048/.052	.118/.120
243	4.130	.048/.052	.118/.120
244	4.255	.048/.052	.118/.120
245	4.380	.048/.052	.118/.120
246	4.505	.048/.052	.118/.120
247	4.630	.048/.052	.118/.120
325	1.497	.071/.075	.184/.186
326	1.622	.071/.075	.184/.186
327	1.748	.071/.075	.184/.186
328	1.873	.071/.075	.184/.186
329	1.998	.071/.075	.184/.186
330	2.123	.071/.075	.184/.186
331	2.248	.071/.075	.184/.186
332	2.373	.071/.075	.184/.186
333	2.498	.071/.075	.184/.186
334	2.623	.071/.075	.184/.186
335	2.748	.071/.075	.184/.186
336	2.873	.071/.075	.184/.186
337	2.998	.071/.075	.184/.186
338	3.123	.071/.075	.184/.186
339	3.248	.071/.075	.184/.186
340	3.373	.071/.075	.184/.186
341	3.498	.071/.075	.184/.186
342	3.623	.071/.075	.184/.186
343	3.748	.071/.075	.184/.186
344	3.873	.071/.075	.184/.186
345	3.998	.071/.075	.184/.186
346	4.123	.071/.075	.184/.186
347	4.248	.071/.075	.184/.186
348	4.373	.071/.075	.184/.186
349	4.498	.071/.075	.184/.186
	+ .002/ - .000		
425	4.502	.106/.110	.235/.237
426	4.627	.106/.110	.235/.237
427	4.752	.106/.110	.235/.237

Dash Number MS27595	Seal Dimensions		
	A I.D.	B Radial Cross-Section	C Width
	+ .002/ - .000		
428	4.877	.106/.110	.235/.237
429	5.002	.106/.110	.235/.237
430	5.127	.106/.110	.235/.237
431	5.252	.106/.110	.235/.237
432	5.377	.106/.110	.235/.237
433	5.502	.106/.110	.235/.237
434	5.627	.106/.110	.235/.237
435	5.752	.106/.110	.235/.237
436	5.877	.106/.110	.235/.237
437	6.002	.106/.110	.235/.237
438	6.252	.106/.110	.235/.237
439	6.502	.106/.110	.235/.237
440	6.752	.106/.110	.235/.237
441	7.002	.106/.110	.235/.237
442	7.252	.106/.110	.235/.237
443	7.502	.106/.110	.235/.237
444	7.752	.106/.110	.235/.237
445	8.002	.106/.110	.235/.237
	+ .003/ - .003		
446	8.502	.106/.110	.235/.237
447	9.002	.106/.110	.235/.237
448	9.502	.106/.110	.235/.237
449	10.002	.106/.110	.235/.237
450	10.502	.106/.110	.235/.237
	+ .004/ - .004		
451	11.002	.106/.110	.235/.237
452	11.502	.106/.110	.235/.237
453	12.002	.106/.110	.235/.237
454	12.502	.106/.110	.235/.237
455	13.002	.106/.110	.235/.237
	+ .005/ - .005		
456	13.502	.106/.110	.235/.237
457	14.002	.106/.110	.235/.237
458	14.502	.106/.110	.235/.237
459	15.002	.106/.110	.235/.237
460	15.502	.106/.110	.235/.237

NOTE: For sizes larger than those shown in the table, please contact your local Parker Seal representative.

The items described in this document and other documents and descriptions provided by Parker Hannifin Corporation, its subsidiaries and its authorized distributors ("Seller") are hereby offered for sale at prices to be established by Seller. This offer and its acceptance by any customer ("Buyer") shall be governed by all of the following Terms and Conditions. Buyer's order for any item described in its document, when communicated to Seller verbally, or in writing, shall constitute acceptance of this offer. All goods, services or work described will be referred to as "Products".

1. Terms and Conditions. Seller's willingness to offer Products, or accept an order for Products, to or from Buyer is subject to these Terms and Conditions or any newer version of the terms and conditions found on-line at www.parker.com/saleterms/. Seller objects to any contrary or additional terms or conditions of Buyer's order or any other document issued by Buyer.

2. Price Adjustments; Payments. Prices stated on Seller's quote or other documentation offered by Seller are valid for 30 days, and do not include any sales, use, or other taxes unless specifically stated. Unless otherwise specified by Seller, all prices are F.C.A. Seller's facility (INCOTERMS 2010). Payment is subject to credit approval and is due 30 days from the date of invoice or such other term as required by Seller's Credit Department, after which Buyer shall pay interest on any unpaid invoices at the rate of 1.5% per month or the maximum allowable rate under applicable law.

3. Delivery Dates; Title and Risk; Shipment. All delivery dates are approximate and Seller shall not be responsible for any damages resulting from any delay. Regardless of the manner of shipment, title to any products and risk of loss or damage shall pass to Buyer upon placement of the products with the shipment carrier at Seller's facility. Unless otherwise stated, Seller may exercise its judgment in choosing the carrier and means of delivery. No deferment of shipment at Buyers' request beyond the respective dates indicated will be made except on terms that will indemnify, defend and hold Seller harmless against all loss and additional expense. Buyer shall be responsible for any additional shipping charges incurred by Seller due to Buyer's acts or omissions.

4. Warranty. Seller warrants that the Products sold hereunder shall be free from defects in material or workmanship for a period of twelve months from the date of delivery to Buyer or 2,000 hours of normal use, whichever occurs first. The prices charged for Seller's products are based upon the exclusive limited warranty stated above, and upon the following disclaimer: **DISCLAIMER OF WARRANTY: THIS WARRANTY COMPRISES THE SOLE AND ENTIRE WARRANTY PERTAINING TO PRODUCTS PROVIDED HEREUNDER. SELLER DISCLAIMS ALL OTHER WARRANTIES, EXPRESS AND IMPLIED, INCLUDING DESIGN, MERCHANTABILITY AND FITNESS FOR A PARTICULAR PURPOSE.**

5. Claims; Commencement of Actions. Buyer shall promptly inspect all Products upon delivery. No claims for shortages will be allowed unless reported to the Seller within 10 days of delivery. No other claims against Seller will be allowed unless asserted in writing within 30 days after delivery. Buyer shall notify Seller of any alleged breach of warranty within 30 days after the date the defect is or should have been discovered by Buyer. Any action based upon breach of this agreement or upon any other claim arising out of this sale (other than an action by Seller for an amount due on any invoice) must be commenced within 12 months from the date of the breach without regard to the date breach is discovered.

6. LIMITATION OF LIABILITY. UPON NOTIFICATION, SELLER WILL, AT ITS OPTION, REPAIR OR REPLACE A DEFECTIVE PRODUCT, OR REFUND THE PURCHASE PRICE. IN NO EVENT SHALL SELLER BE LIABLE TO BUYER FOR ANY SPECIAL, INDIRECT, INCIDENTAL OR CONSEQUENTIAL DAMAGES ARISING OUT OF, OR AS THE RESULT OF, THE SALE, DELIVERY, NON-DELIVERY, SERVICING, USE OR LOSS OF USE OF THE PRODUCTS OR ANY PART THEREOF, OR FOR ANY CHARGES OR EXPENSES OF ANY NATURE INCURRED WITHOUT SELLER'S WRITTEN CONSENT, EVEN IF SELLER HAS BEEN NEGLIGENT, WHETHER IN CONTRACT, TORT OR OTHER LEGAL THEORY. IN NO EVENT SHALL SELLER'S LIABILITY UNDER ANY CLAIM MADE BY BUYER EXCEED THE PURCHASE PRICE OF THE PRODUCTS.

7. User Responsibility. The user, through its own analysis and testing, is solely responsible for making the final selection of the system and Product and assuring that all performance, endurance, maintenance, safety and warning requirements of the application are met. The user must analyze all aspects of the application and follow applicable industry standards and Product information. If Seller provides Product or system options, the user is responsible for determining that such data and specifications are suitable and sufficient for all applications and reasonably foreseeable uses of the Products or systems.

8. Loss to Buyer's Property. Any designs, tools, patterns, materials, drawings, confidential information or equipment furnished by Buyer or any other items which become Buyer's property, will be considered obsolete and may be destroyed by Seller after two consecutive years have elapsed without Buyer ordering the items manufactured using such property. Seller shall not be responsible for any loss or damage to such property while it is in Seller's possession or control.

9. Special Tooling. A tooling charge may be imposed for any special tooling, including without limitation, dies, fixtures, molds and patterns, acquired to manufacture Products. Such special tooling shall be and remain Seller's property notwithstanding payment of any charges by Buyer. In no event will Buyer acquire any interest in apparatus belonging to Seller which is utilized in the manufacture of the Products, even if such apparatus has been specially converted or adapted for such manufacture and notwithstanding any charges paid by Buyer. Unless otherwise agreed, Seller shall have the right to alter, discard or otherwise dispose of any special tooling or other property in its sole discretion at any time.

10. Buyer's Obligation; Rights of Seller. To secure payment of all sums due or otherwise, Seller shall retain a security interest in the goods delivered and this agreement shall be deemed a Security Agreement under the Uniform Commercial Code. Buyer authorizes Seller as its attorney to execute and file on Buyer's behalf all documents Seller deems necessary to perfect its security interest.

11. Improper use and Indemnity. Buyer shall indemnify, defend, and hold Seller harmless from any claim, liability, damages, lawsuits, and costs (including attorney fees), whether for personal injury, property damage, patent, trademark or copyright infringement or any other claim, brought by or incurred by Buyer, Buyer's employees,

or any other person, arising out of: (a) improper selection, improper application or other misuse of Products purchased by Buyer from Seller; (b) any act or omission, negligent or otherwise, of Buyer; (c) Seller's use of patterns, plans, drawings, or specifications furnished by Buyer to manufacture Product; or (d) Buyer's failure to comply with these terms and conditions. Seller shall not indemnify Buyer under any circumstance except as otherwise provided.

12. Cancellations and Changes. Orders shall not be subject to cancellation or change by Buyer for any reason, except with Seller's written consent and upon terms that will indemnify, defend and hold Seller harmless against all direct, incidental and consequential loss or damage. Seller may change product features, specifications, designs and availability with notice to Buyer.

13. Limitation on Assignment. Buyer may not assign its rights or obligations under this agreement without the prior written consent of Seller.

14. Force Majeure. Seller does not assume the risk and shall not be liable for delay or failure to perform any of Seller's obligations by reason of circumstances beyond the reasonable control of Seller (hereinafter "Events of Force Majeure"). Events of Force Majeure shall include without limitation: accidents, strikes or labor disputes, acts of any government or government agency, acts of nature, delays or failures in delivery from carriers or suppliers, shortages of materials, or any other cause beyond Seller's reasonable control.

15. Waiver and Severability. Failure to enforce any provision of this agreement will not waive that provision nor will any such failure prejudice Seller's right to enforce that provision in the future. Invalidation of any provision of this agreement by legislation or other rule of law shall not invalidate any other provision herein. The remaining provisions of this agreement will remain in full force and effect.

16. Termination. Seller may terminate this agreement for any reason and at any time by giving Buyer thirty (30) days written notice of termination. Seller may immediately terminate this agreement, in writing, if Buyer: (a) commits a breach of any provision of this agreement (b) appointments a trustee, receiver or custodian for all or any part of Buyer's property (c) files a petition for relief in bankruptcy on its own behalf, or by a third party (d) makes an assignment for the benefit of creditors, or (e) dissolves or liquidates all or a majority of its assets.

17. Governing Law. This agreement and the sale and delivery of all Products hereunder shall be deemed to have taken place in and shall be governed and construed in accordance with the laws of the State of Ohio, as applicable to contracts executed and wholly performed therein and without regard to conflicts of laws principles. Buyer irrevocably agrees and consents to the exclusive jurisdiction and venue of the courts of Cuyahoga County, Ohio with respect to any dispute, controversy or claim arising out of or relating to this agreement.

18. Indemnity for Infringement of Intellectual Property Rights. Seller shall have no liability for infringement of any patents, trademarks, copyrights, trade dress, trade secrets or similar rights except as provided in this Section. Seller will defend and indemnify Buyer against allegations of infringement of U.S. patents, U.S. trademarks, copyrights, trade dress and trade secrets ("Intellectual Property Rights"). Seller will defend at its expense and will pay the cost of any settlement or damages awarded in an action brought against Buyer based on an allegation that a Product sold pursuant to this Agreement infringes the Intellectual Property Rights of a third party. Seller's obligation to defend and indemnify Buyer is contingent on Buyer notifying Seller within ten (10) days after Buyer becomes aware of such allegations of infringement, and Seller having sole control over the defense of any allegations or actions including all negotiations for settlement or compromise. If a Product is subject to a claim that it infringes the Intellectual Property Rights of a third party, Seller may, at its sole expense and option, procure for Buyer the right to continue using the Product, replace or modify the Product so as to make it noninfringing, or offer to accept return of the Product and return the purchase price less a reasonable allowance for depreciation. Notwithstanding the foregoing, Seller shall have no liability for claims of infringement based on information provided by Buyer, or directed to Products delivered hereunder for which the designs are specified in whole or part by Buyer, or infringements resulting from the modification, combination or use in a system of any Product sold hereunder. The foregoing provisions of this Section shall constitute Seller's sole and exclusive liability and Buyer's sole and exclusive remedy for infringement of Intellectual Property Rights.

19. Entire Agreement. This agreement contains the entire agreement between the Buyer and Seller and constitutes the final, complete and exclusive expression of the terms of sale. All prior or contemporaneous written or oral agreements or negotiations with respect to the subject matter are herein merged.

20. Compliance with Law, U. K. Bribery Act and U.S. Foreign Corrupt Practices Act. Buyer agrees to comply with all applicable laws and regulations, including both those of the United Kingdom and the United States of America, and of the country or countries of the Territory in which Buyer may operate, including without limitation the U. K. Bribery Act, the U.S. Foreign Corrupt Practices Act ("FCPA") and the U.S. Anti-Kickback Act (the "Anti-Kickback Act"), and agrees to indemnify and hold harmless Seller from the consequences of any violation of such provisions by Buyer, its employees or agents. Buyer acknowledges that they are familiar with the provisions of the U. K. Bribery Act, the FCPA and the Anti-Kickback Act, and certifies that Buyer will adhere to the requirements thereof. In particular, Buyer represents and agrees that Buyer shall not make any payment or give anything of value, directly or indirectly to any governmental official, any foreign political party or official thereof, any candidate for foreign political office, or any commercial entity or person, for the purpose of influencing such person to purchase products or otherwise benefit the business of Seller.

[Click to Go to
CATALOG
Table of Contents](#)

[Click to Go to
CATALOG
Table of Contents](#)

[Click to Go to
CATALOG
Table of Contents](#)

[Click to Go to
CATALOG
Table of Contents](#)

Click to Go to
CATALOG
Table of Contents

Worldwide Fluid Power Sealing

North America

EPS Division, Headquarters
Salt Lake City, Utah
phone 801 972 3000
fax 801 973 4019

Asia Pacific

China
Parker Hannifin Motion & Control (Shanghai) Co., Ltd.
phone 86 21 2899 5181
fax 86 21 5834 8975

Europe

Germany
Parker Prädifa
phone 49 7142 351 0
fax 49 7142 351293

Denmark

Polar Seals ApS
phone 45 49 121700
fax 45 49 121701

Belgium

Parker Hannifin, Advanced Products, NV
phone 32 3 880 81 50
fax 32 3 888 48 62

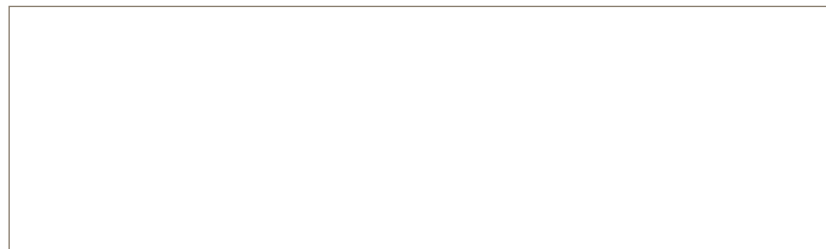

Your Local Authorized Parker Distributor

EPS 5370 Digital 06/2014



Parker Hannifin Corporation
Engineered Polymer Systems Division
2220 South 3600 West
Salt Lake City, UT 84119
phone 801 972 3000
fax 801 973 4019
www.parker.com/eps

U.S. \$75.00